

# MAC 2000 Wash XB Upgrade Kit Installation Guide

## Introduction

This Installation Guide explains how to install the MAC 2000 Wash XB Upgrade Kit to convert a standard MAC 2000 Wash to an XB model that uses a 1500 watt Osram HTI 1500 W/D7/60 SharXS lamp.

The MAC 2000 Wash XB Upgrade Kit has part number P/N 91310980.

For the latest documentation and information about this and all Martin Professional products, please visit the Martin website at [www.martin.com](http://www.martin.com).

Martin has a buy-back offer for electronic ballasts from MAC 2000 Wash fixtures that are upgraded to XB models. Please do not send ballasts to Martin without following the correct procedure for the buy-back scheme. If you have Login rights to the Support area at [www.martin.com](http://www.martin.com) you can see details there. Otherwise please contact your Martin distributor for details.

Installation of the upgrade kit consists of two sequences of operations: replacement of components in the base, and replacement of components in the head.

**Warning!** *Read and follow the safety precautions in the MAC 2000 Wash XB user manual before installing the MAC 2000 Wash XB Upgrade Kit. The user manual is supplied with the Upgrade Kit and is also available for download from [www.martin.com](http://www.martin.com)*

*Disconnect the fixture from power, allow to cool and place on a workbench before starting work.*

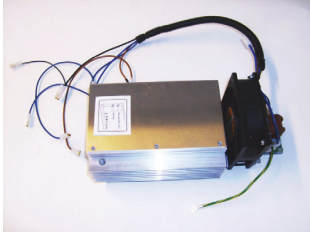
*The MAC 2000 Wash XB Upgrade Kit must be installed by qualified professional technicians only. Read all of this Installation Guide carefully before starting to install the Upgrade Kit. Martin Professional A/S and its affiliated companies cannot be held responsible for any injury, damage, direct or indirect loss, consequential or economic loss or any other loss resulting from failure to follow the instructions, respect the safety precautions and carry out the safety tests listed in this Installation Guide.*

*If you have any questions about how to install the Upgrade Kit or use the MAC 2000 Wash XB safely, please contact your local Martin distributor (see [www.martin.com/distributors](http://www.martin.com/distributors) for details) or call the Martin 24-hour service hotline on +45 8740 0000, or in the USA on 1-888-tech-180.*

**Important!** *To avoid damage to PCBs and their sensitive electronic components, take precautions to avoid ESD (electrostatic discharge) and carry out work at an ESD-free workstation. Do not get oil or grease onto optical components. If necessary, clean components with 99.9% isopropyl alcohol.*

# Overview

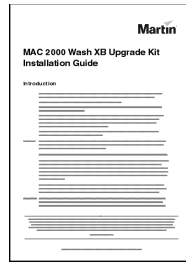
The MAC 2000 Wash XB Upgrade Kit contains the following items:



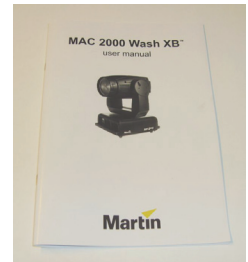
**A**



**B**



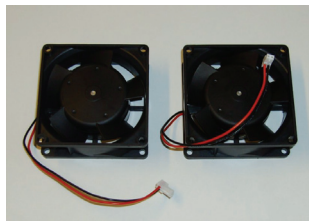
**C**



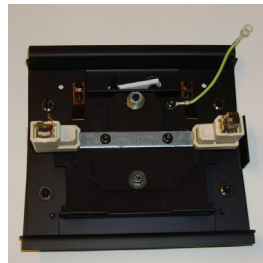
**D**



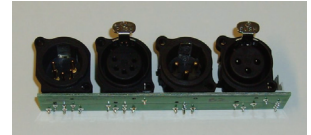
**E**



**F**



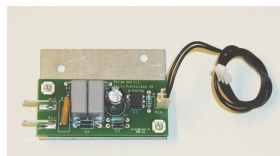
**G**



**H**



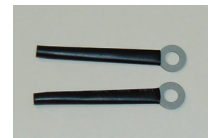
**I**



**J**



**K**



**L**



**M**



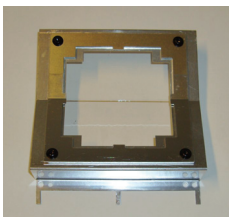
**N**



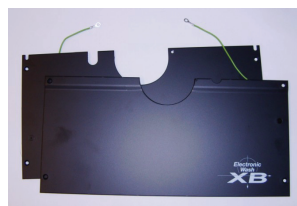
**O**



**P**



**Q**



**R**



**S**



**T**

Table 1



**U**



**V**



**W**



**X**

**Table 1**

**Parts list**

A	Electronic ballast module	P/N 55205560	O	Lamp fan/thermoswitch assembly, R	P/N 62406058
B	CMY+C and dimmer module	P/N 55205110	P	Lamp fan assembly, L	P/N 62406064
C	This instruction note	P/N 35000600	Q	Heat filter module	P/N 62323015
D	MAC 2000 Wash XB user manual	P/N 35000219	R	Base lid A with ground lead	P/N 55205504
E	Ignitor (starter) with plug	P/N 62228025	R	Base lid B with ground lead	P/N 55205505
F	12 VDC 3" high-speed fan (x2)	P/N 62222079	S	Lamp wire clamp plate retainer	P/N 08074402
G	Lamp housing rear cover module	P/N 55205111	T	High-temperature cable tie (x25)	P/N 13104000
H	Data connections panel	P/N 62004554	U	M6x10 ch. allen bolt low black (x3)	P/N 08111201
I	Osram HTI 1500W/D7/60 lamp	P/N 97010322	V	M4x10 Torx self-tapping screw (x2)	P/N 08070701
J	Remote lamp on/off opto-switch	P/N 55205580	W	M4x12 bh. Torx screw black (x8)	P/N 08070710
K	Reduced lamp power (dimmer) circuit leads (main PCB to ballast), 640 mm	P/N 11730006	X	Replacement product label*	P/N 33140086*
L	Wire retainer, flexible, 4 mm (x2)	P/N 13101010			
M	Thermoswitch, fixed bracket (x2)	P/N 05040023			
N	Heat-shield sleeve 340 mm (x2)	P/N 62400444			

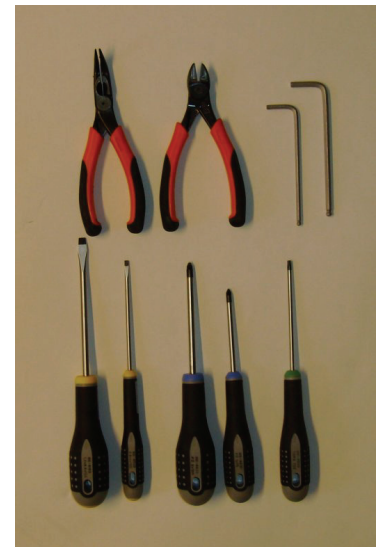
*\*The replacement product label part number was wrongly listed as P/N 33190032 in revisions A to C of this Installation Note. P/N 33140086 is the correct part number for this label.*

**Tools required**

All screw sizes given in this Installation Guide are indicative only. The following tools are normally required to upgrade a standard MAC 2000 Wash to an XB model. However, if screws have been replaced during service, for example, you may find that other tools are required.

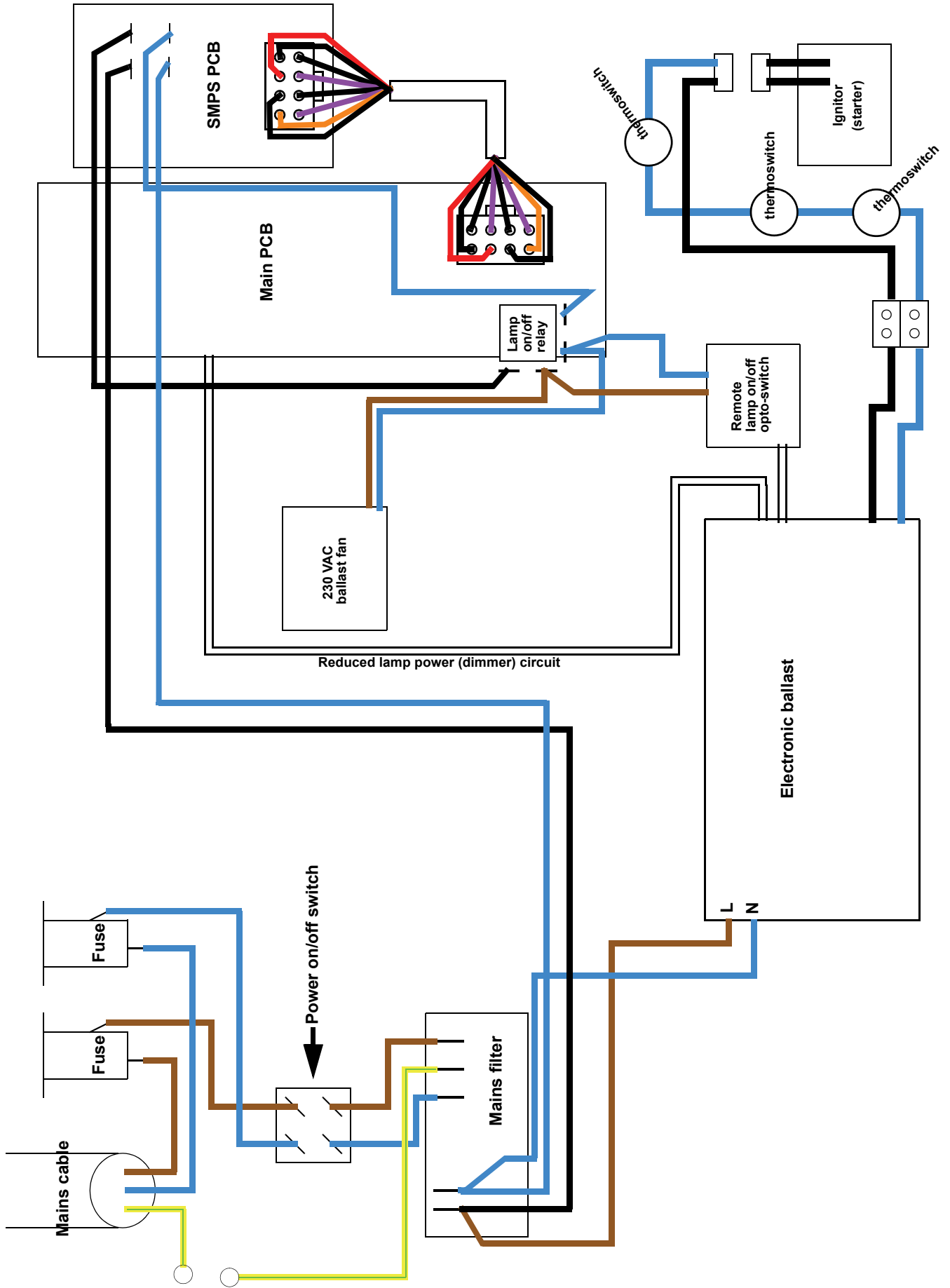
- needle-nose pliers
- wire cutters
- 4 mm and 5 mm Allen keys
- 2 x flathead screwdrivers
- Pozidriv PZ1 and PZ2 screwdrivers (all cross-head screws in MAC 2000 Wash fixtures are Pozidriv, not plain Phillips type)
- Torx TX20 screwdriver

To help you avoid dropping screws into the fixture, we recommend that you magnetize tools so that screws cling to them.



# Schematic wiring diagram

Wireset version 2, P/N 11850226-A





# Replacement of components in the base

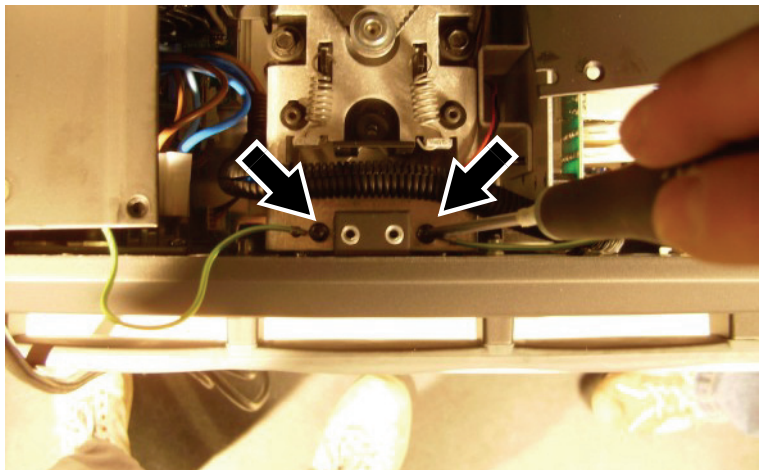
To install the MAC 2000 Wash XB Upgrade Kit base components in a standard MAC 2000 Wash fixture:

1. Disconnect the fixture from power, allow to cool, and place on a workbench. Take precautions against ESD (electro-static discharge).
2. See Figure 1. Remove the four screws from the corners of each base cover (8 screws total, PZ2, P/N 08070502). Keep the screws for re-use during reassembly.



**Figure 1**

3. See Figure 2. Slide the covers out slightly for access to the ground (earth) leads. Disconnect the ground leads by removing their screws (arrowed, Torx 20, P/N 08070701) and remove the covers. Keep the screws. The covers are no longer required as new items are supplied in the Upgrade Kit.



**Figure 2**

4. Use the pan lock (arrowed in Figure 3) and tilt lock to immobilize the head.



**Figure 3**

- Lay the fixture down carefully on its side and remove the screw third from the left (arrowed, Torx 20, P/N 08190404) from the bottom of the base on the ballast side. Keep the screw for re-use during installation.

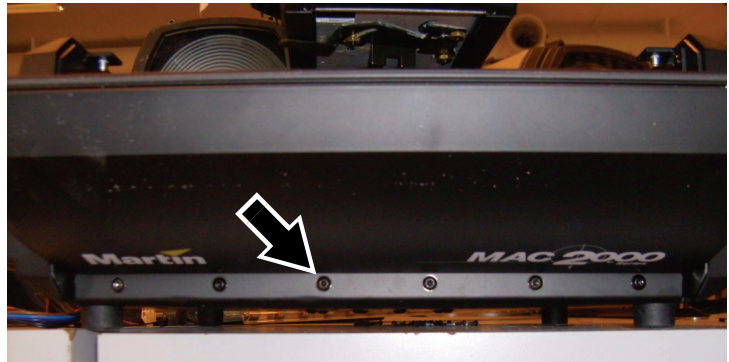


Figure 4

- See Figure 5. Use a 4 mm Allen key to remove the three ballast mounting screws **A** from their holes (arrowed) around the serial number label in the base. In older fixtures, you must also remove a fourth ballast mounting screw **B**. Throw these screws away because three new ballast mounting screws are provided in the Upgrade Kit. When you install the new ballast, you will insert the new mounting screws in the holes at **A**.

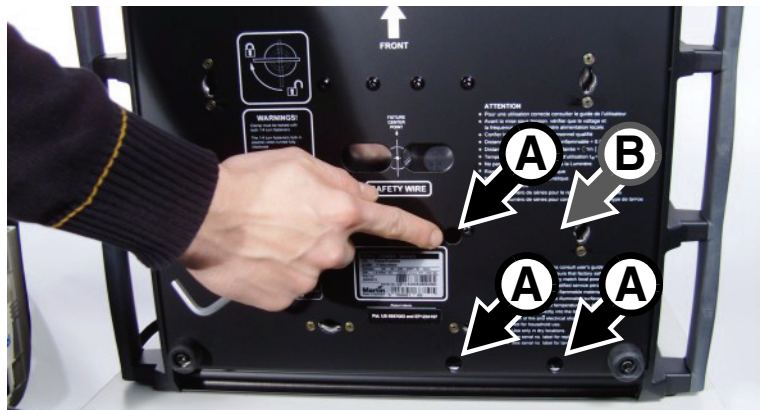


Figure 5

- See Figure 6. Stand the fixture up again. Remove the four Allen screws (P/N 08111206) **A** from the top corners of the base panels on both sides of the fixture. Remove the two Allen screws (P/N 08111210) **B** from the bottom corners of the base panels on the ballast side of the fixture and remove the ballast side base cover **B** completely. Keep the side cover and all screws for re-use.



Figure 6

- See Figure 7. Loosen the Allen screws (P/N 08111210) **C** in the bottom corners of the base panels on the main PCB side of the fixture and swing the main PCB side base cover **A** open.

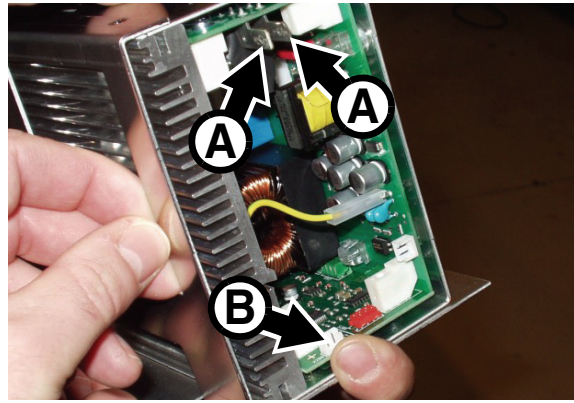


Figure 7



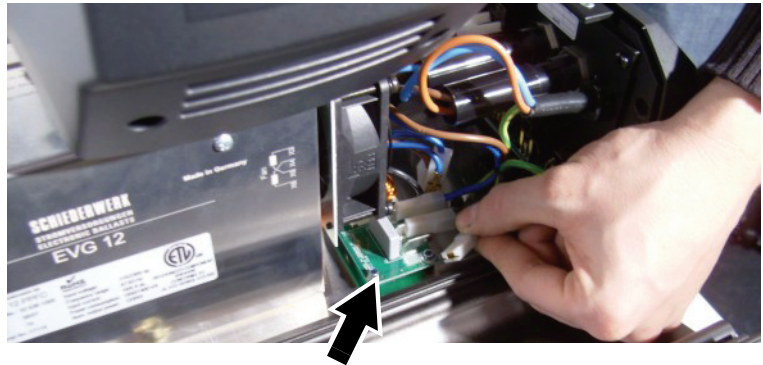
9. See Figure 8. Lift the ballast up slightly and disconnect the two ignitor leads (one blue, one black) from their spade connectors **A**. Then disconnect the reduced lamp power (dimmer) circuit connector from connector X200 **B**.

*NB: Figure 8 shows the ballast completely removed from the fixture to make it easier to see the connectors.*



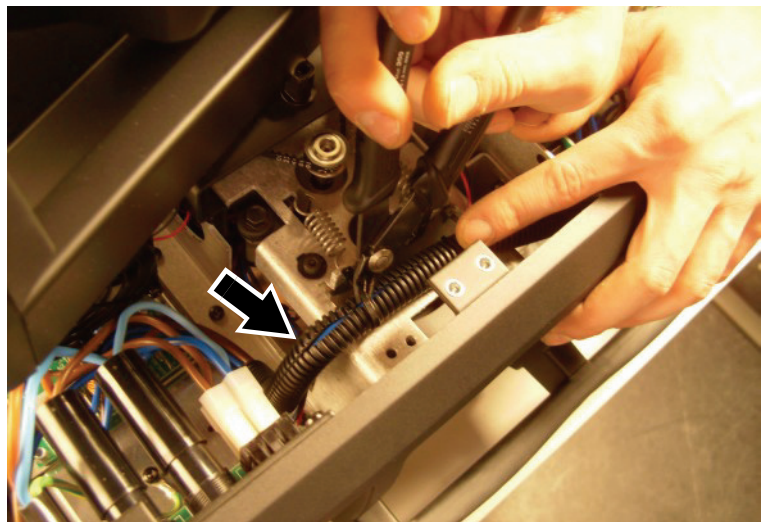
**Figure 8**

10. See Figure 9. Cut cable ties if necessary and disconnect the mains power leads from PL1, PL2 and PL3 on the mains filter PCB (arrowed) that is part of the ballast assembly.



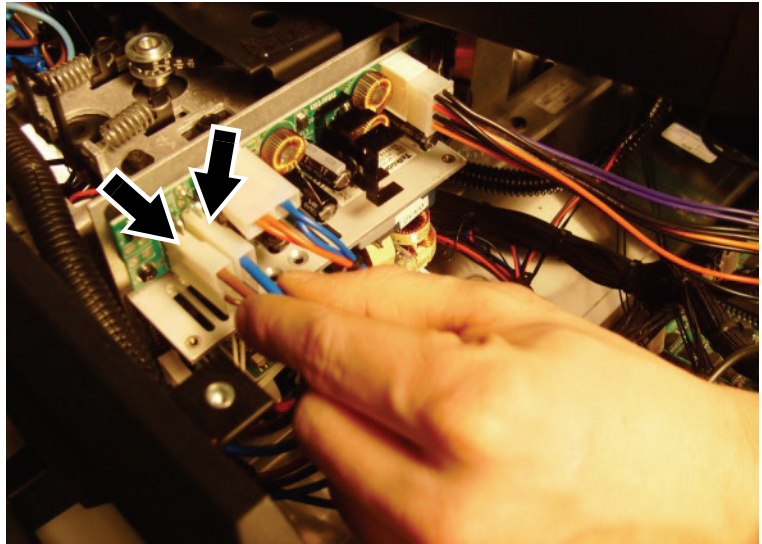
**Figure 9**

11. See Figure 10. Unlock the pan lock and swing the head around for access, then use a wire-cutter to cut the cable ties and release the ballast wiring harness (arrowed) that runs from the ballast to the main PCB.



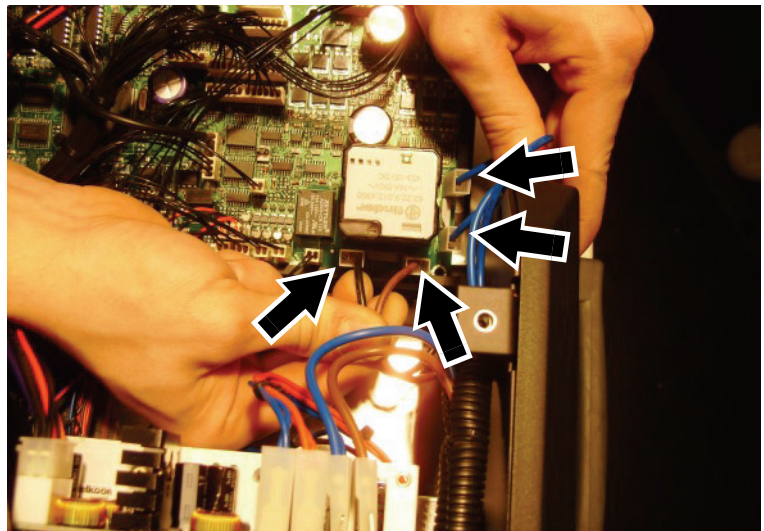
**Figure 10**

12. See Figure 11. Disconnect the thick blue and brown leads (arrowed) from the SMPS (switch-mode power supply).



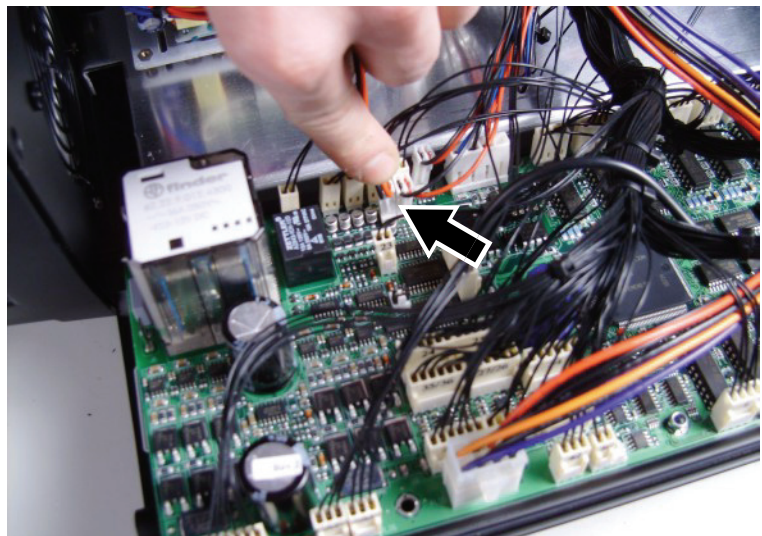
**Figure 11**

13. See Figure 12. Disconnect the 2 blue leads, the black lead and the brown lead from connectors J4, J5, J6 and J8 (arrowed) around the lamp on/off relay on the main PCB.



**Figure 12**

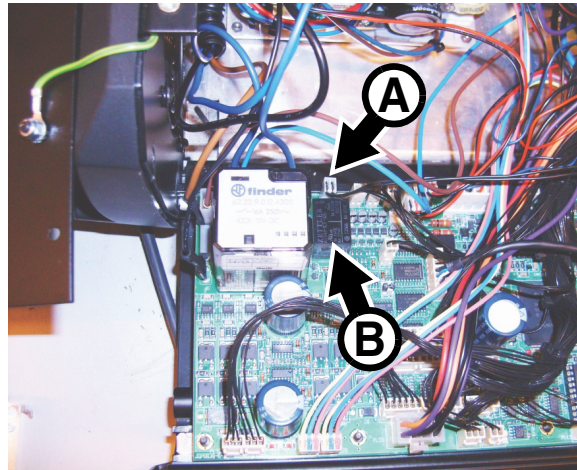
14. See Figure 13. Disconnect the low-voltage ballast fan connector (arrowed) from connector PL58 (F7) on the main PCB.  
*The new ballast has a 230 V cooling fan, so the low-voltage ballast fan connector at PL58 on the main PCB will no longer be used when you install new components.*



**Figure 13**

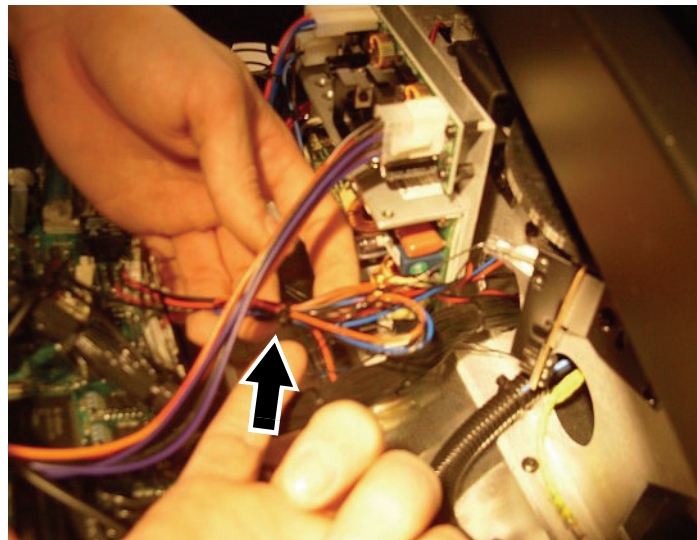


15. See Figure 14. Disconnect the reduced lamp power (dimmer) circuit connector **A** from connector PL49 behind the reduced lamp power relay **B** on the main PCB.



**Figure 14**

16. See Figure 15. Cut the cable tie (arrowed) on the ballast fan leads.



**Figure 15**

17. See Figure 16. Lift the ballast out of the base of the fixture and set aside for possible return to Martin under the buy-back scheme (see "Introduction" on page 1).



**Figure 16**

18. See Figure 17. Two types of XLR connector modules have been fitted to the MAC 2000 Wash. If your fixture has the wider type module **A** with the 4-pin connector (arrowed) behind the XLR sockets, there will not be enough space to install the new ballast so you must replace the module with the narrower type **B** with the 4-pin connector (arrowed) in line with the sockets at the end of the PCB. A module type **B** is supplied in the Upgrade Kit (P/N 62004554, see “H” in Table 1). If the narrower type module **B** is already installed, just keep the module supplied in the Upgrade Kit as a spare.

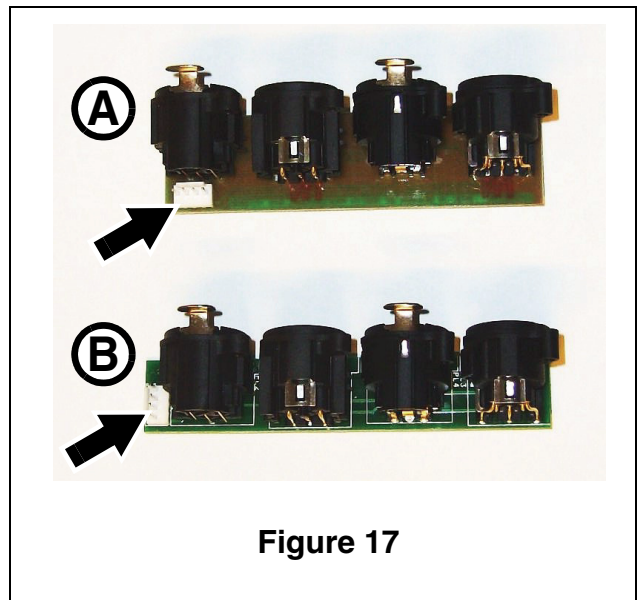


Figure 17

To replace the XLR module, unplug the module at its 4-pin connector, unscrew the 8 screws (PZ1, P/N 08200102) around the XLR sockets on the connections plate and lift the module out of the fixture. Install the new XLR module supplied with the Upgrade Kit re-using the 8 screws, and connect the plug to the new module’s 4-pin connector.

19. See Figure 18. You must now relocate the mains input cable ground (earth) lead to make space for the new ballast. First, strip some of the outer insulation from the mains cable at **A**.

20. See Figure 18. Unscrew the Torx 20 screw **B** (P/N 08070701) that fastens the lead to the metal base plate. Throw this screw away. Move the mains input cable ground lead to the existing hole **C** in the base plate and fasten it to the base plate with one of the new Torx 20 screws, P/N 08070701, supplied in the Upgrade Kit (see “V” in Table 1). To make sure the lead does not foul the new ballast, fasten the screw with the lead trailing out towards the fixture’s XLR connectors.

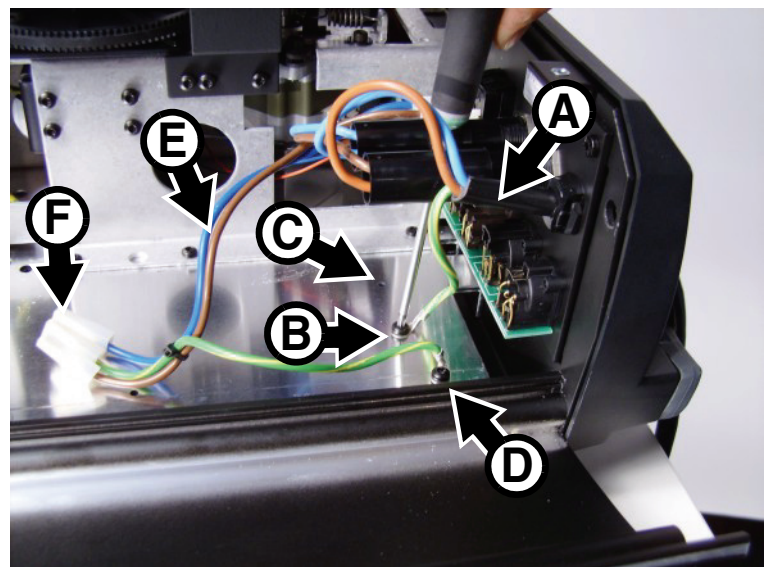


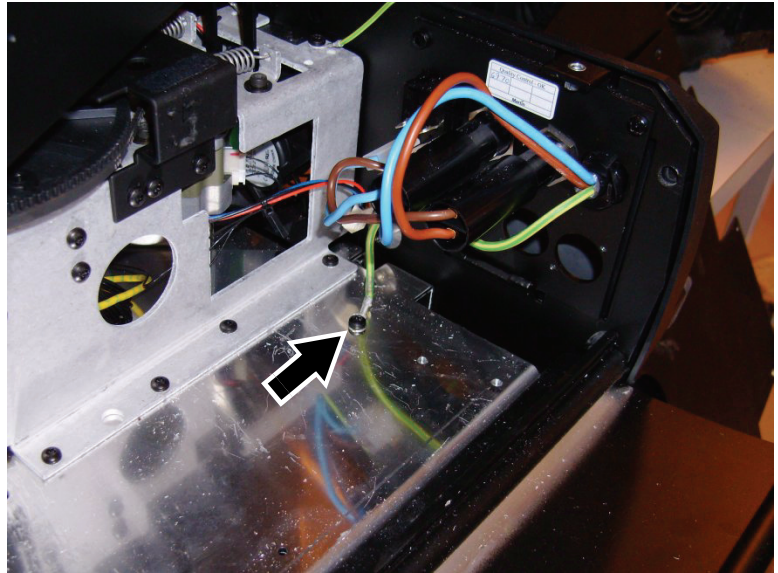
Figure 18

Remove screw **D** from the mains filter ground lead. This screw is no longer required. Disconnect the blue and brown leads **E** from the fixture’s power on/off switch, and remove the ground lead and blue and brown leads with their connector **F**. These leads are no longer required. New leads are supplied installed on the mains filter on the new ballast assembly.

**Warning!** For safety reasons, the two ground (earth) leads – one from the fixture’s mains input cable and one from the mains filter on the ballast assembly – shown at **B** and **D** in Figure 18 **MUST** be fastened to the base plate separately with two separate screws when the new ballast assembly is installed. **DO NOT** take a short-cut and use one single screw to fasten these two ground leads to the base plate together, or you will create a safety risk, void the product warranty and make the product illegal.



21. When you have completed step 20, the fixture should look as shown in Figure 19 with the relocated mains input cable ground lead (arrowed) fastened to the base plate and trailing back towards the XLR connectors.



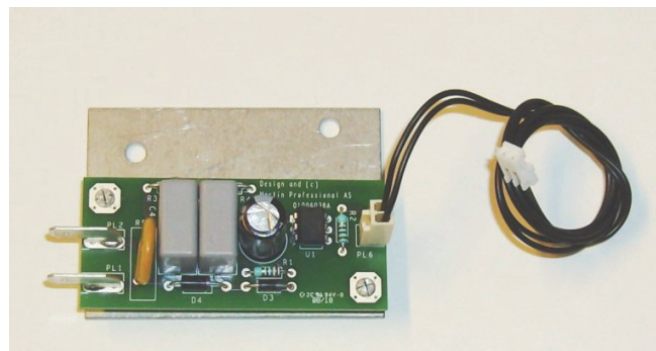
**Figure 19**

22. See Figure 20. Place the new ballast loosely in the base and check that it will not foul any wiring or other component when installed. Adjust wiring or components if necessary, Do not fasten the ballast to the fixture yet because you must make electrical connections first.



**Figure 20**

23. See Figure 21. An opto-switch for the remote lamp on/off circuit is supplied with the Upgrade Kit (see "J" in Table 1).



**Figure 21**

24. See Figure 22. Remove the two Torx 20 screws (P/N 08070701) arrowed from the chassis facing the main PCB, noting that a ground (earth) lead is fastened to one of the screws.

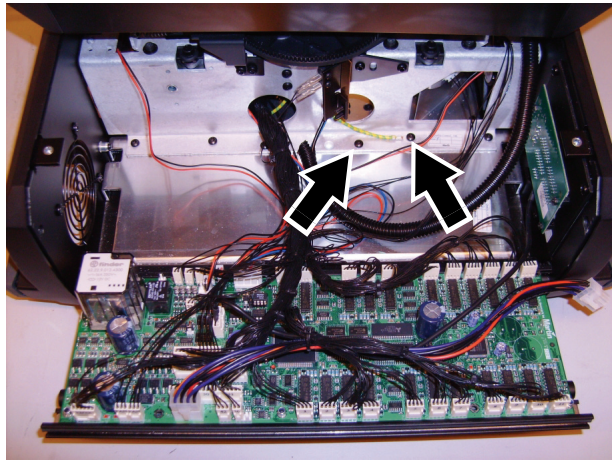


Figure 22

25. See Figure 23. Fasten the remote lamp on/off opto-switch **A** to the base as shown, re-using the original 2 screws and re-installing the ground lead on the screw where it was originally located. A pair of leads with connectors is supplied installed on the remote lamp on/off opto-switch. Both connectors are marked **LA**. See Figure 23. One connector is installed at **B** on the remote lamp on/off opto-switch PCB. Route the two leads alongside the ballast wiring harness **C** over to the ballast

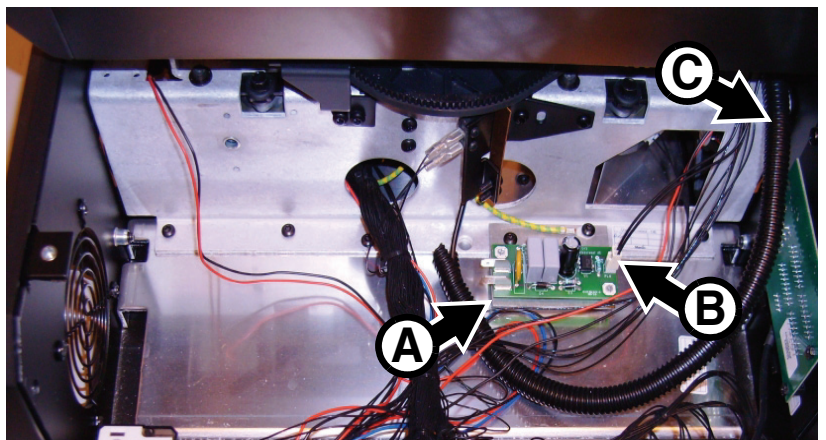


Figure 23

26. See Figure 24. A jumper will normally be fitted on the upper low-voltage multi-connector X301 (arrowed) on the ballast PCB. Remove the jumper and connect the pair of leads from the remote lamp on/off opto-switch to connector X301 as shown in Figure 24.

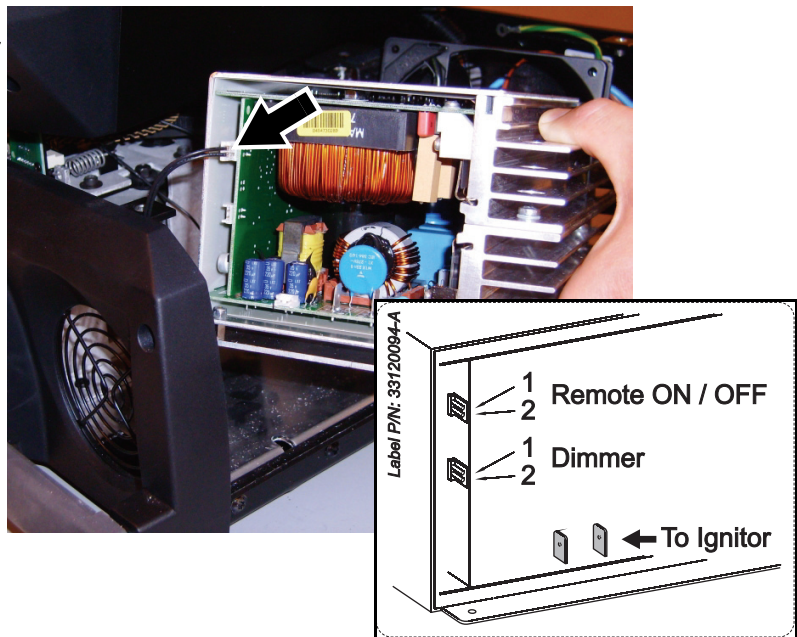


Figure 24



27. See Figure 25. Connect the reduced lamp power (dimmer) circuit leads supplied with the Upgrade Kit (P/N 11730006, see “K” in Table 1) to the lower low-voltage multi-connector X200 (arrowed) on the ballast PCB.

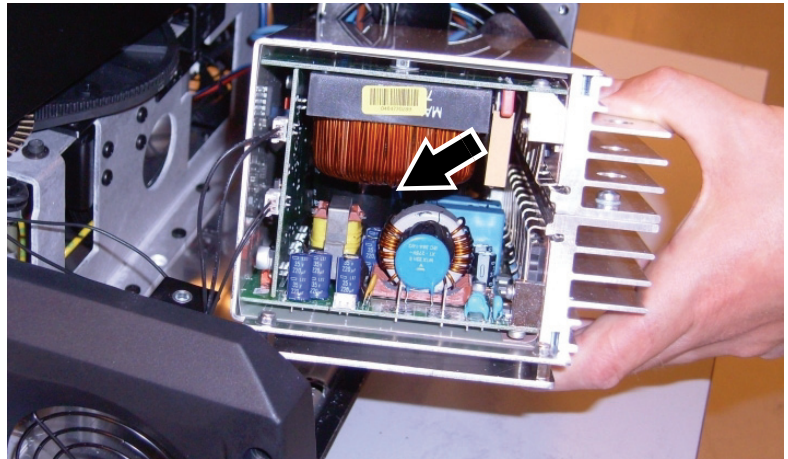


Figure 25

28. See Figure 26. Route the reduced lamp power (dimmer) circuit leads alongside the ballast wiring harness over to the main PCB and plug them into connector PL49 A behind the reduced lamp power relay B on the main PCB.

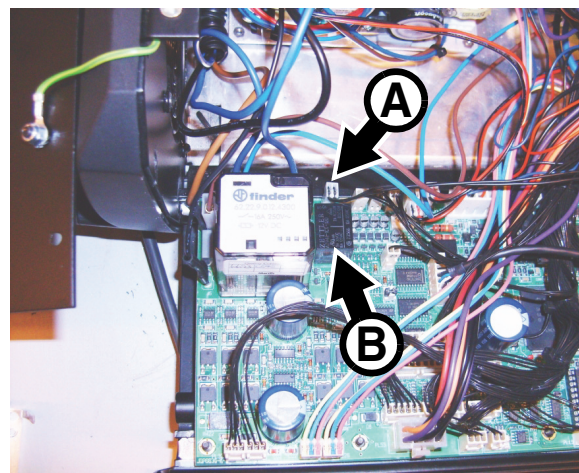


Figure 26

29. See Figure 27. Connect the blue lead and black lead from the ignitor (starter) to the spade connectors (arrowed) in the base of the new ballast. *Polarity is not important – the blue and black leads are interchangeable.*

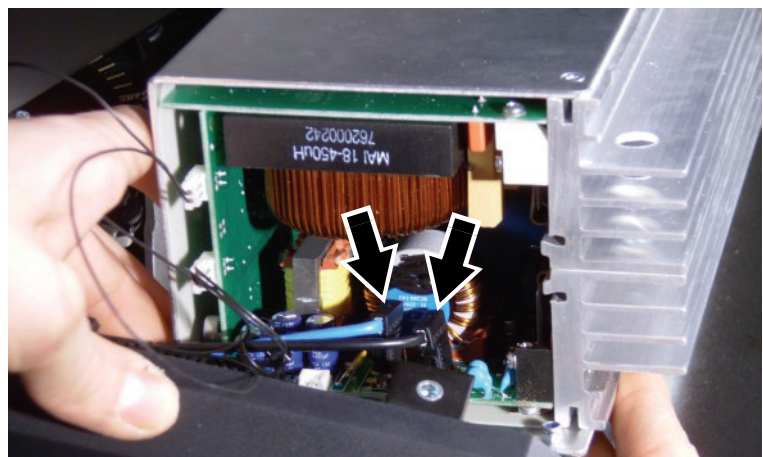
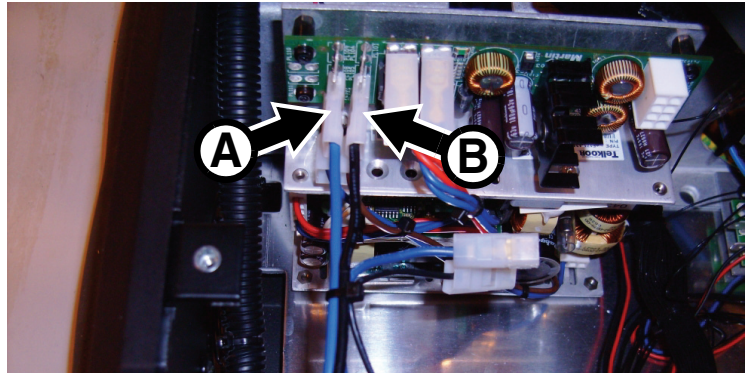


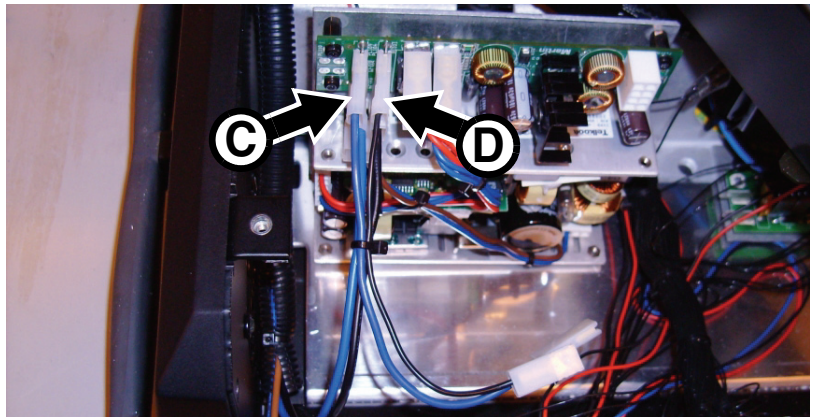
Figure 27

30. See Figure 28. Route the ballast wiring harness from the mains filter on the ballast PCB over the connections panel side of the base to the lamp on/off relay on the main PCB. Connect the long blue lead **A** from the mains filter to spade connector PL108 on the SMPS PCB. Connect the long black lead **B** to spade connector PL105.



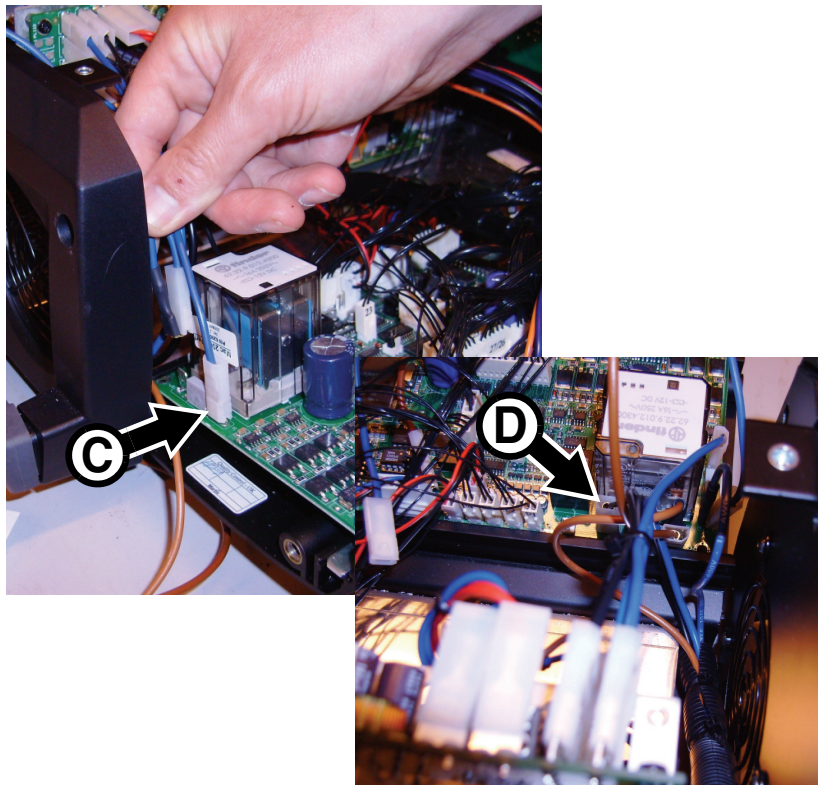
**Figure 28**

31. See Figure 29. A short blue lead **C** is secured with a cable tie to the end of the ballast wiring harness. Connect one end of this short blue lead to spade connector PL109 on the SMPS PCB. Connect one end of the short black lead **D** to spade connector PL106.



**Figure 29**

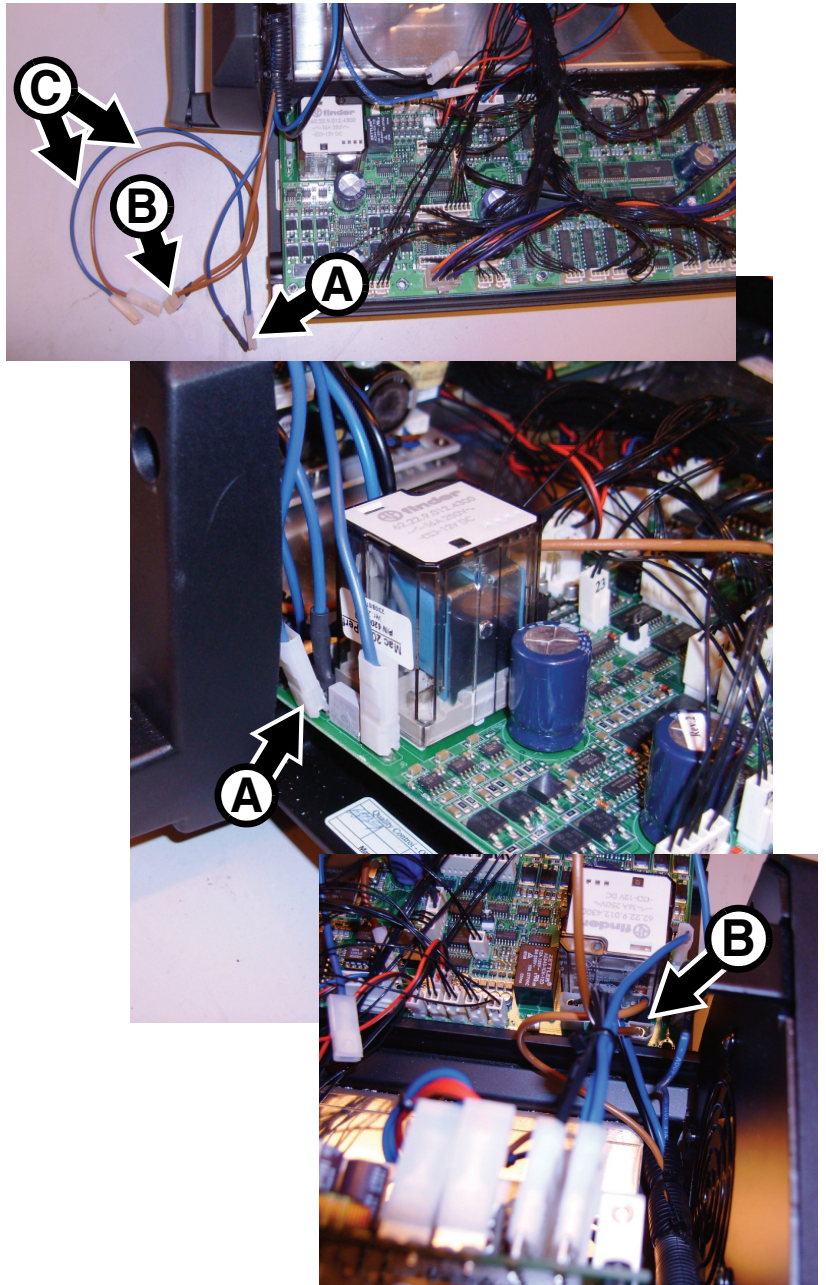
32. See Figure 30. Connect the other end of the short blue lead **C** to spade connector J6 beside the lamp on/off relay on the main PCB. Connect the other end of the short black lead **D** to spade connector J4 on the other side of the lamp on/off relay.



**Figure 30**

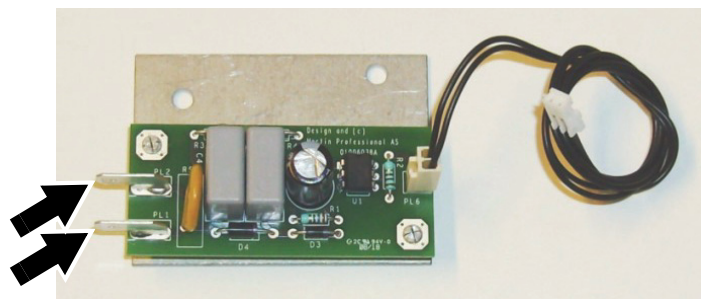


33. See Figure 31. Still working with the ballast wiring harness from the mains filter, connect the double spade connector with the blue leads **A** to connector J8 beside the lamp on/off relay, and connect the double spade connector with the brown leads **B** to connector J5. make sure that the double spade connectors will not be trapped or squeezed when you close the PCB side cover.



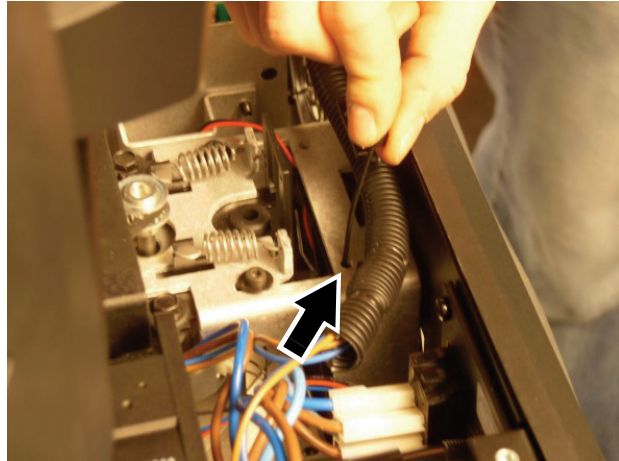
**Figure 31**

34. You are now left with one free blue and one free brown lead (**C** in Figure 31) connected to the double spade connectors you have just installed. See Figure 32. Connect the free blue lead and the free brown lead to spade connectors PL1 and PL2 (arrowed) on the remote lamp on/off opto-switch PCB you installed in step 25. (photo shows PCB before installation). Polarity is not important.



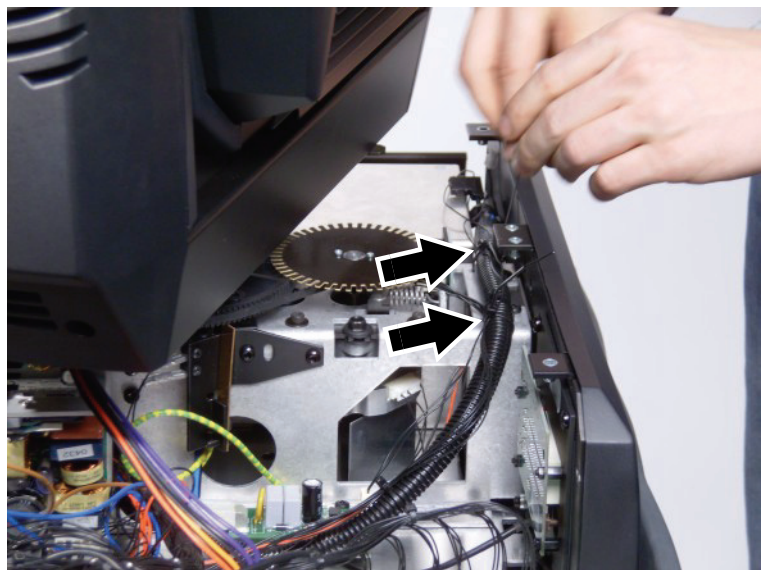
**Figure 32**

35. See Figure 33. Use a cable tie to fasten the ballast wiring harness in its sleeve along the side panel and well away from all moving parts.



**Figure 33**

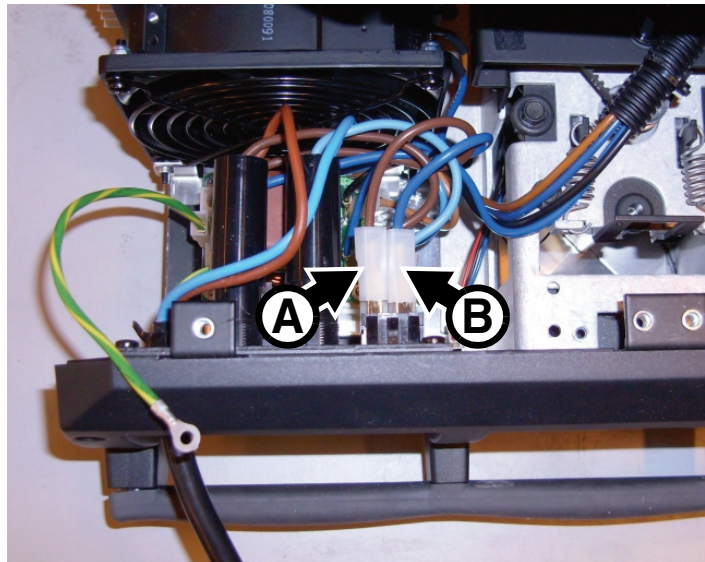
36. See Figure 34. The low-voltage leads from the remote lamp on/off opto-switch PCB to the ballast and from the reduced lamp power circuit on the main PCB to the ballast must also be secured. Use cable ties to fasten them to the main ballast output cable sleeve as shown in the photo.



**Figure 34**



37. See Figure 35. Connect the brown **Live** power input lead on the mains filter to the spade connector **A** above the existing brown lead on the power on/off switch. Connect the blue **Neutral** power input lead on the mains filter to the spade connector **B** above the existing blue lead on the power on/off switch.

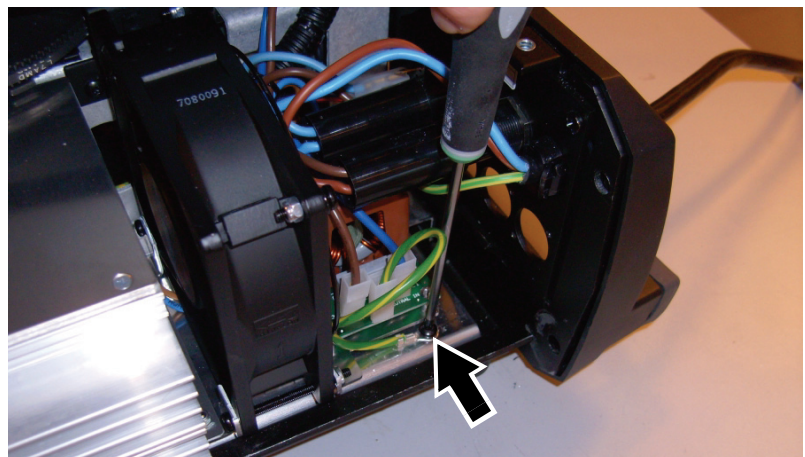


**Figure 35**

38. Check that the new ballast is correctly positioned in the base. Lay the fixture on its side and fasten the ballast with the three Allen screws (P/N 08111201, see “U” in Table 1) supplied in the Upgrade Kit, passing these screws through the base in the holes shown at **A** in Figure 5 on page 6.

39. Reinstall the third screw from the left in the bottom of the base on the ballast side (see Figure 4).

40. See Figure 36. Stand the fixture upright again and fasten the mains filter ground lead to the base plate, re-using the original screw in the hole arrowed in Figure 36 and shown at **D** in Figure 18 on page 10.



**Figure 36**

41. Check that the wiring in the base is correctly connected with reference to “Schematic wiring diagram” on page 4. Check that all wiring is held securely away from moving parts. Attach wiring with extra cable ties if necessary.

42. Reinstall the base side covers shown in Figure 7 on page 6. A new base cover A (P/N 55205504) for the main PCB side of the base and a new base cover B (P/N 55205505) for the ballast side of the base are supplied in the Upgrade Kit. Fasten the new covers’ ground leads to the base as shown in Figure 2 on page 5 and fasten the covers to the base re-using the original eight PZ2 screws (P/N 08070502).

*You will need to open the ballast side covers again for final safety testing after all work has been completed. Closing the base covers at this point will ensure that no screws or other items fall into the base while you work on the head.*

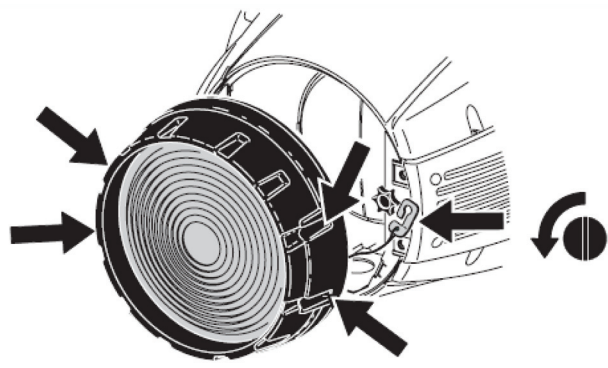
## Replacement of components in the head

41. See Figure 37. Use a large flathead screwdriver to release the quarter-turn retaining screws from both head covers, unhook the safety straps and remove the covers. Keep the covers for re-use.



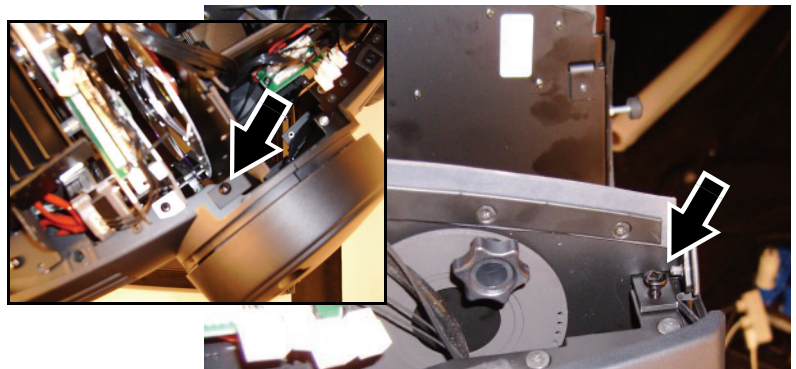
**Figure 37**

42. See Figure 38. Use a large flathead screwdriver to release the four quarter-turn retaining screws that hold the front lens, loosen the safety strap thumbscrew, unhook the safety strap and remove the front lens. Keep the lens for re-use.



**Figure 38**

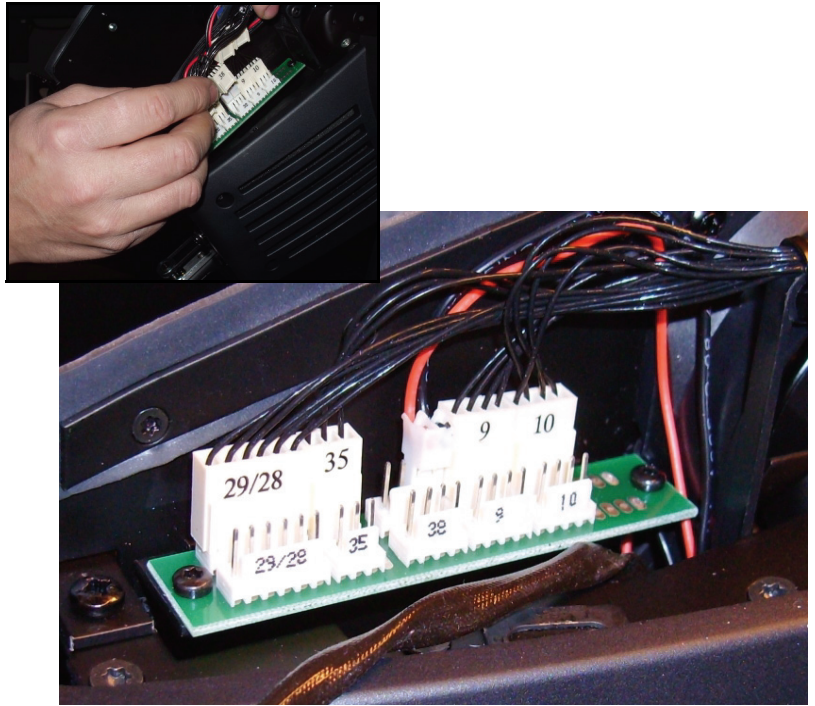
43. See Figure 39. Remove the four zoom/focus module retaining screws (PZ2, P/N 08070404), two on each side of the head. Keep the screws for re-use during re-installation.



**Figure 39**

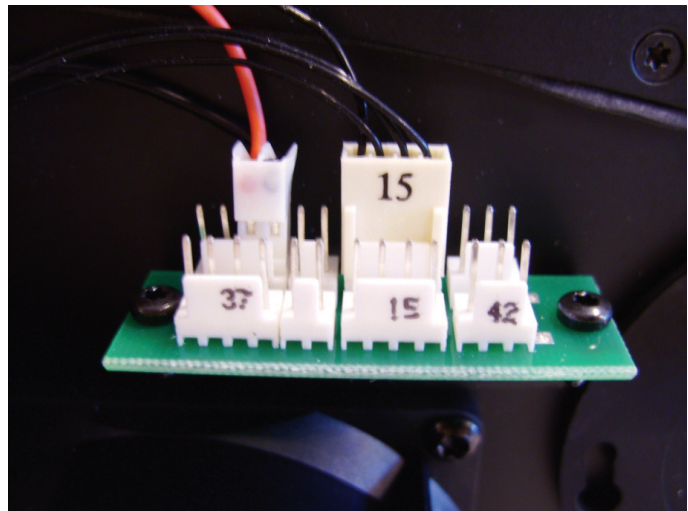


44. Disconnect all the outer row of zoom/focus module multi-connectors plus the left-hand lamp fan plug on the front two pins of connector 38 on the inner row on the left-hand side of the head, leaving the connectors as shown in Figure 40.



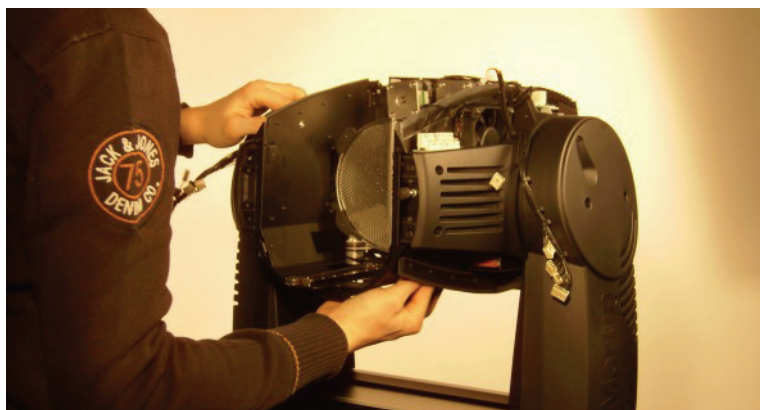
**Figure 40**

45. Disconnect all the zoom/focus module multi-connectors apart from plug 15 and the effects fan plug on the front two pins of connector number 37 on the right side of the head, leaving the connectors as shown in Figure 41.



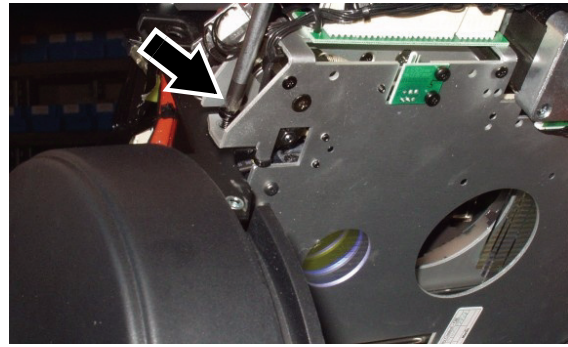
**Figure 41**

46. See Figure 42. Lift the zoom/focus module out of the head and set it to one side.



**Figure 42**

47. See Figure 43. Remove the four screws (PZ2, P/N 08070404) that hold the CMY module, disconnect the module's multi-connectors marked 16, 17, 18, 19, 20, 34, 41 and T and lift the module out of the head. Keep the screws for re-use during re-installation. This module is no longer required, as a new CMY module is supplied in the Upgrade Kit.



**Figure 43**

48. See Figure 44. Remove the two retaining screws (PZ2, P/N 08070404) from each rear head side cover and remove both rear side covers. Keep the screws and covers for re-use during re-installation.
49. Remove the two retaining screws (PZ2, P/N 08070404) from the left-hand front head side cover and remove the cover. Keep the screws and cover for re-use during re-installation.



**Figure 44**

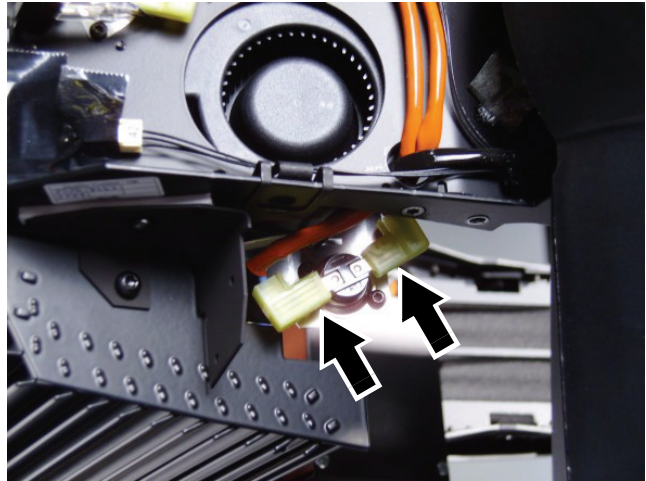
50. See Figure 45. We recommend that you tape loose wiring to each side of the head temporarily to keep it out of the way and avoid damage.



**Figure 45**

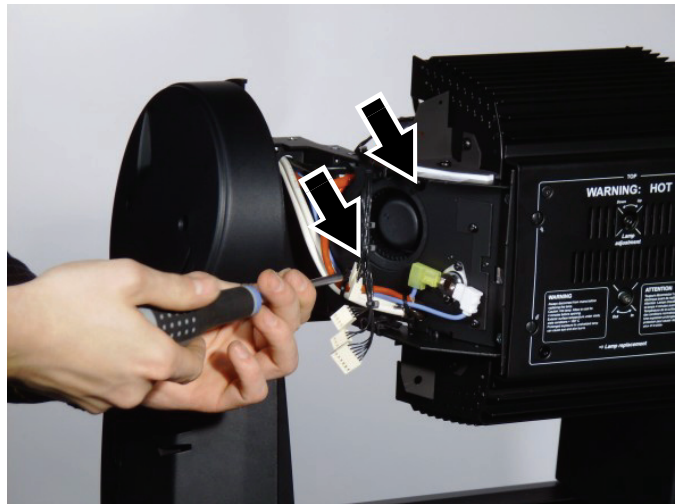


51. See Figure 46. Disconnect the leads (arrowed) from the thermoswitch on the right-hand side lamp fan assembly.



**Figure 46**

52. See Figure 47. Cut cable ties as necessary and pull the lamp fan power leads back towards the fans on both sides of the head until the leads hang free. Remove the fan mounting screws (arrowed, PZ2, P/N 08200107) and remove both the lamp cooling fans complete with their metal heat shields including the thermoswitch mounted on the right-hand heat shield. Keep the screws for re-use later. The fans with their heat shields and thermoswitch are no longer required, as new items are supplied in the Upgrade Kit.



**Figure 47**

53. See Figure 48. A total of four new fans are supplied in the upgrade kit. The two new lamp cooling fans (right-hand fan with thermoswitch = P/N 62406058 and left-hand fan = P/N 62406064) are mounted on metal heat shields. Install the new fans with their heat shields, re-using the existing mounting screws. You are screwing into the plastic fan housings, so do not overtighten screws. Install the fan with the thermoswitch on the right-hand side of the fixture where the old thermoswitch was, and connect the spade connectors from the old thermoswitch (see Figure 46) to the new one. Do not route fan power leads to their connectors yet, as this is easier with the lamp leads from the ignitor to the lamp removed (routing the fan power leads is described in step 59.).



**Figure 48**

54. See Figure 49. Cut the cable ties holding the ignitor wiring.

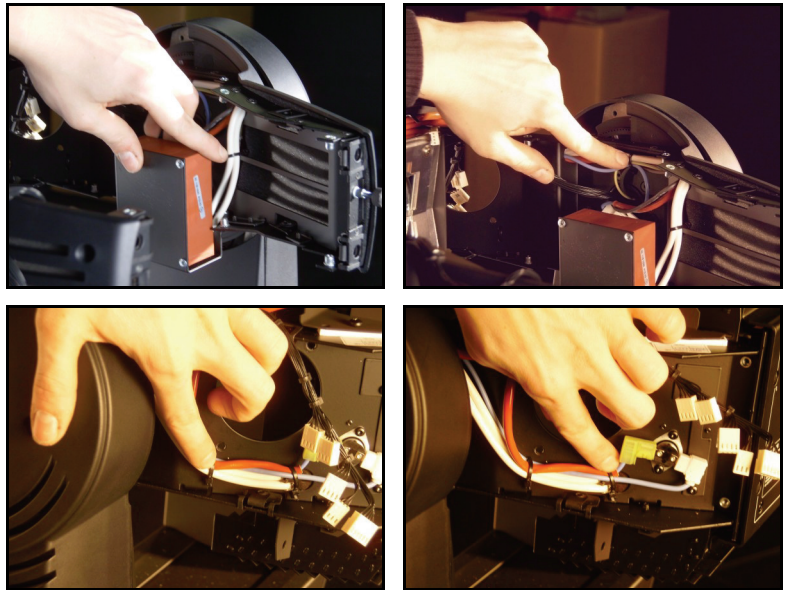


Figure 49

55. See Figure 50. Release the 4 quarter-turn screws (A) in the rear lamp housing cover. Open the cover and remove the lamp. Remove the two Torx 20 cover retaining screws (B) to release the lampholder/rear cover assembly and let it hang from the lamp leads and ground lead (the photo shows the lamp leads already released from their terminals, but you will release them in the next step). Keep the rear cover retaining screws for re-use.

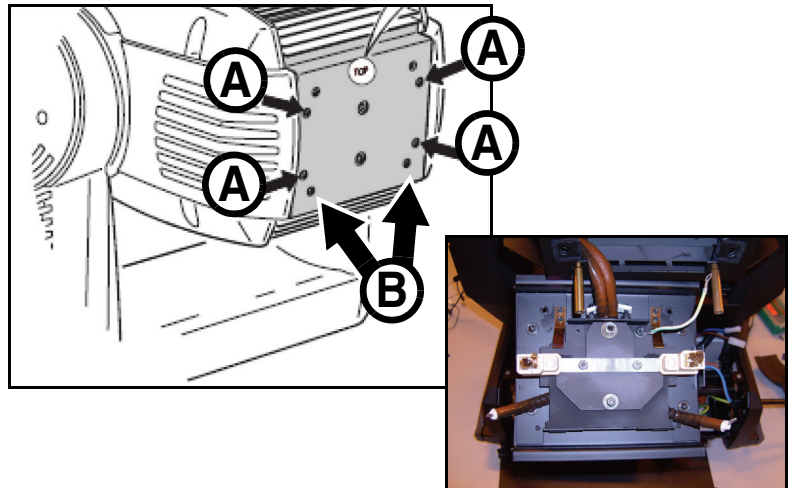


Figure 50

56. See Figure 51. Unscrew the lamp lead clamp screws A and release the leads from their terminals in the lampholder. Unscrew and release the lampholder ground lead B. Release the lamp lead clamp C.

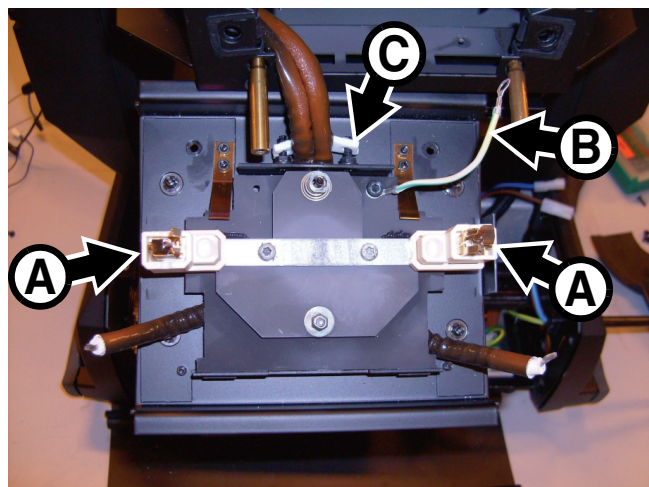
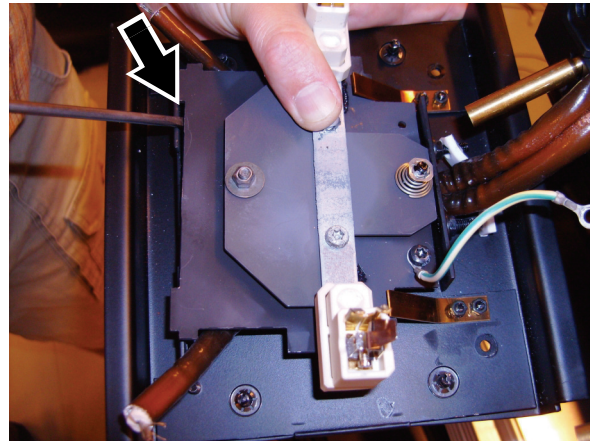


Figure 51

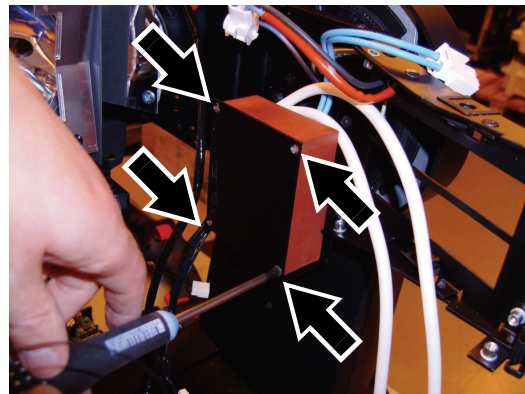


57. See Figure 52. Release the lamp rear plate by levering with a flathead screwdriver (arrowed), then pull the lamp leads clear of the rear cover. You can now remove the lampholder /rear cover assembly completely.



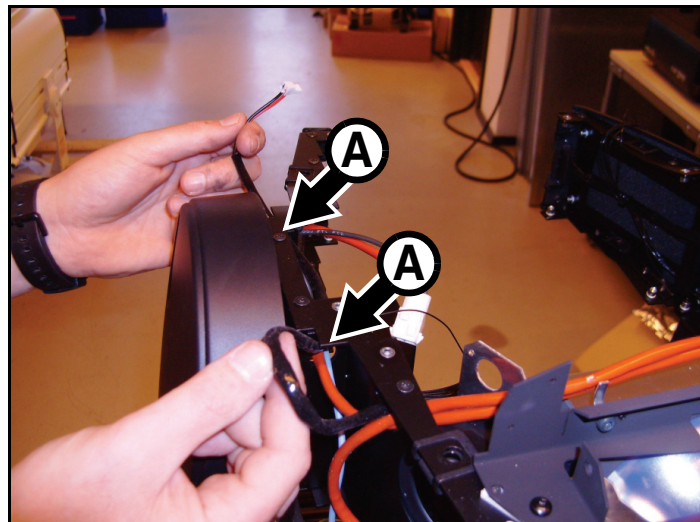
**Figure 52**

58. See Figure 53. Release the lamp leads all the way forward to the ignitor, noting how the lamp leads are routed. Disconnect the ignitor input connector, remove the four ignitor mounting screws (arrowed) and remove the ignitor. Keep the screws for re-use. The ignitor is no longer required, as a new ignitor is supplied with the Upgrade Kit.



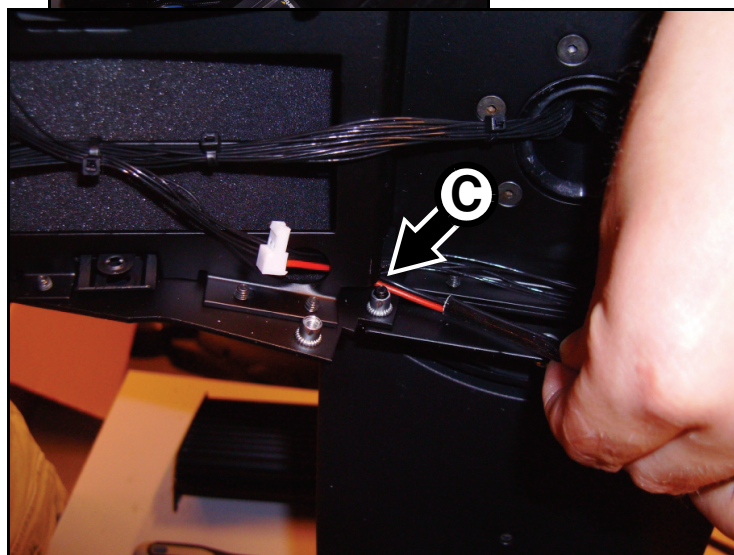
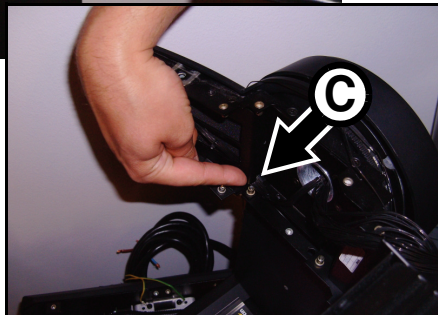
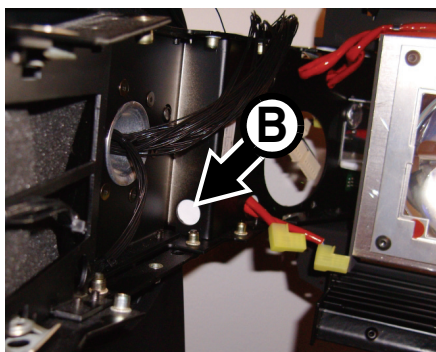
**Figure 53**

59. You must now route the lamp fan leads from the lamp fans to the front of the head just as the original leads were routed. See Figure 54. Thread the left-hand side lamp fan leads through the holes **A** provided for them alongside the ignitor leads. You will plug the lamp fan leads into a connector on the zoom/focus module when you have installed this module later.



**Figure 54**

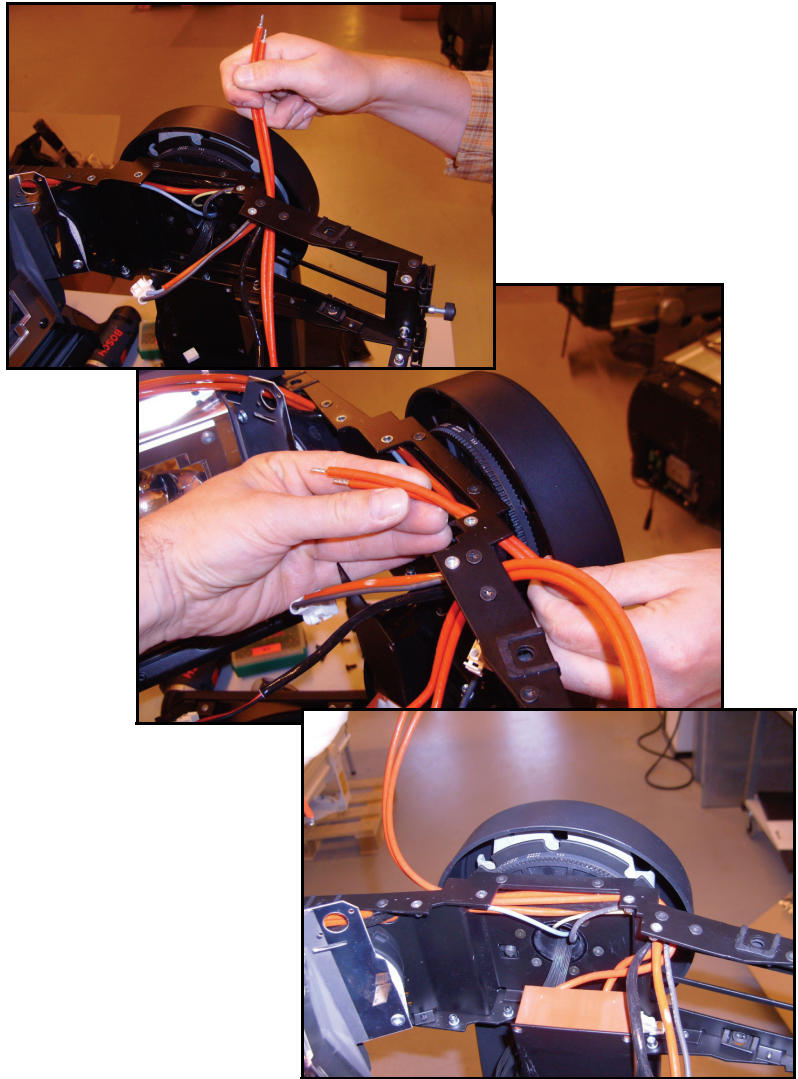
60. See Figure 55. Thread the right-hand side lamp fan leads through the holes provided for them behind (B) and in front of (C) the yoke pivot. You will plug the lamp fan leads into a connector on the zoom/focus module when you have installed this module later.



**Figure 55**

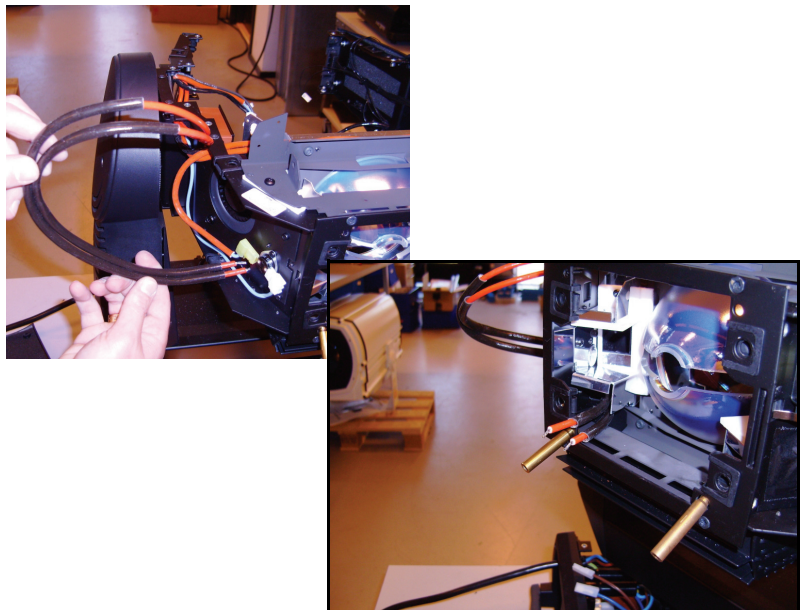


61. See Figure 56. Hold the ignitor up to the head and route the lamp leads from the ignitor back towards the lamp compartment as the original leads were routed.



**Figure 56**

62. See Figure 57. Install the heat sleeve supplied in the Upgrade Kit on the lamp leads and thread the lamp leads into the lamp compartment.



**Figure 57**

63. See Figure 58. Hold the new rear lampholder assembly (P/N 55205111) supplied in the Upgrade Kit up to the back of the head and thread the lamp leads behind the rear lampholder plate towards the lampholder terminals. You may need to release and remove the rear lampholder plate temporarily (as shown in the photo) to make it easier to pass the leads behind it.

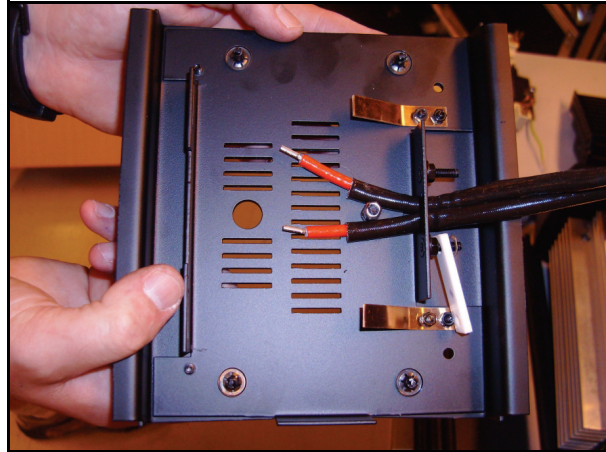


Figure 58

64. See Figure 59. Clamp the lamp leads into the lampholder terminals **A**. Fasten the lampholder ground lead **B** to the head re-using the original screw in the same hole as the original lead. Pull the lamp leads towards the ignitor to eliminate any slack in the lampholder housing, but make sure they are not kinked or under tension. Clamp the lamp leads in place by applying the push-on locking washer **E** supplied with the Upgrade Kit (P/N 08074402) on the lamp lead clamp **C**. Install the lampholder/rear cover assembly on its mounting pillars **D** in the back of the head, re-using the original screws. Apply Loctite 243 on their threads before tightening.

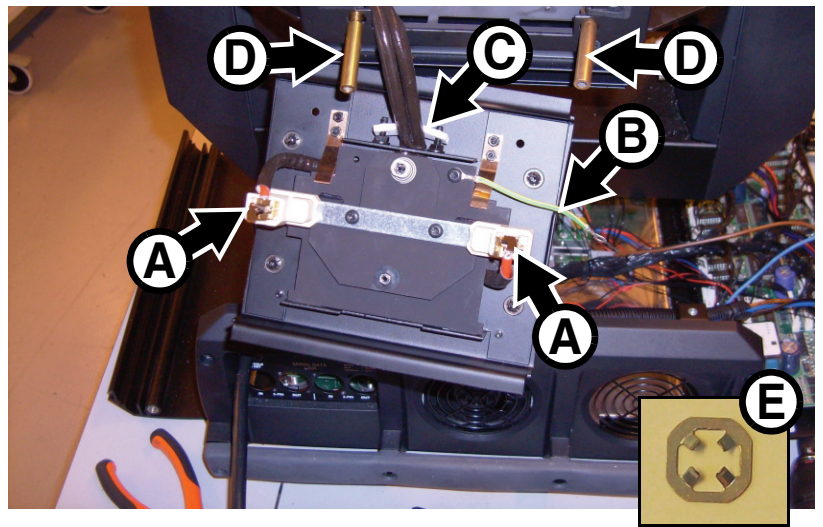


Figure 59

65. See Figure 60. Pull the lamp leads back through the fixture towards the ignitor leaving only enough slack as is necessary to open the rear lamp housing cover.

**Important! Leave as little slack as possible in the lamp leads in the lamp housing.**

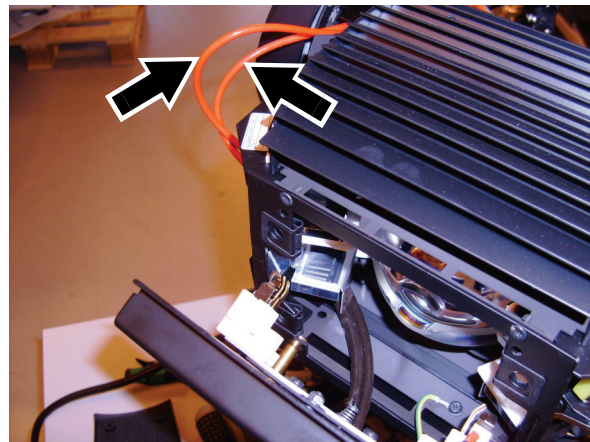
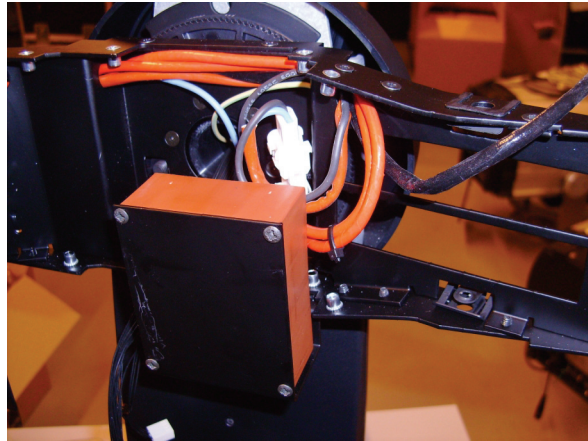


Figure 60



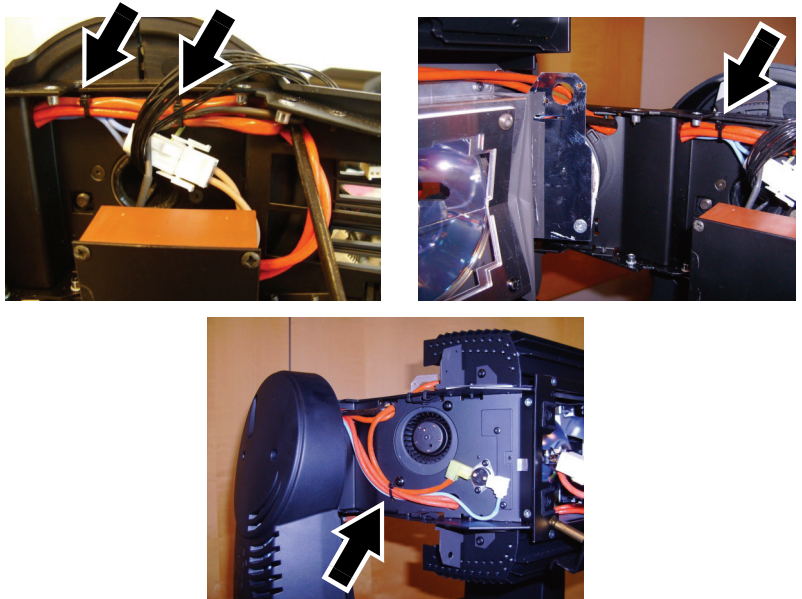
66. See Figure 61. Fasten the ignitor in its mounting bracket re-using the original four screws. Connect the ignitor input connector. Secure wiring with cable ties.

**Important!** Pull the lamp leads back towards the ignitor so that the only place where there is slack in the leads is next to the ignitor, as shown in Figure 61.



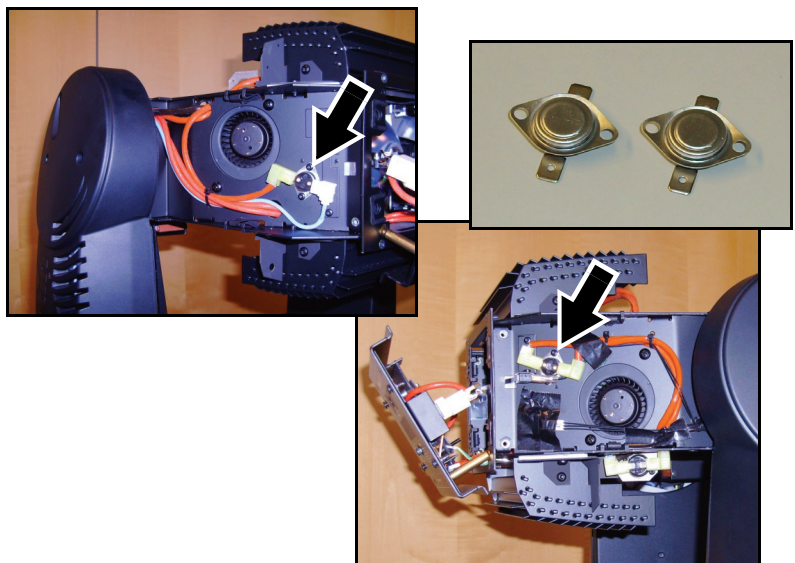
**Figure 61**

67. See Figure 62. Secure the lamp leads with cable ties.



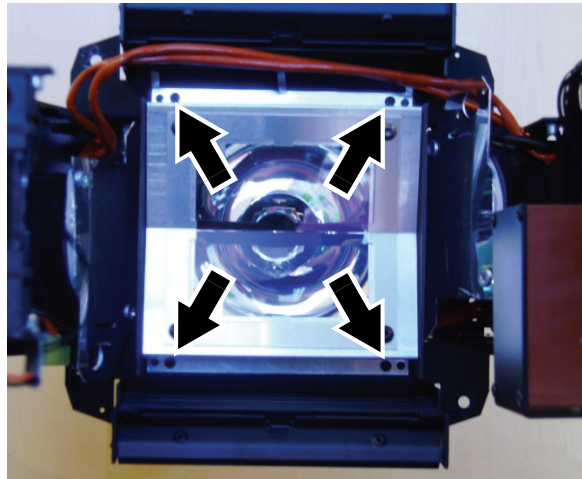
**Figure 62**

68. See Figure 63. Replace the thermostats (arrowed) in both sides of the head with the two new thermostats (P/N 05040023) supplied in the Upgrade Kit, re-using the existing screws.

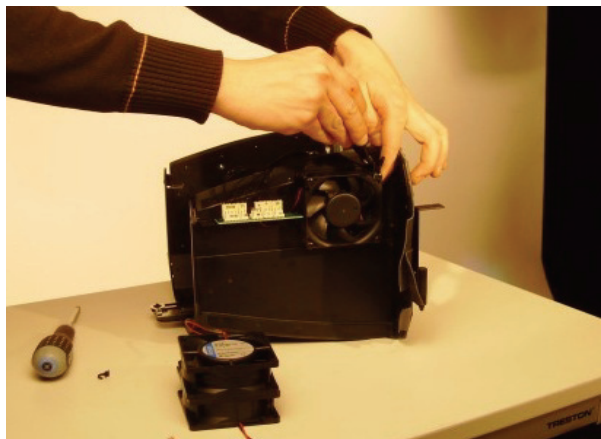


**Figure 63**

69. See Figure 64. Remove the 4 retaining screws (arrowed) from the heat shield assembly and remove the assembly. You will need to open the bend-over tabs and move the thermoswitch wiring out of the way for access to two of the screws. Keep the screws for re-use. Now is a good time to clean the reflector using 99.9% isopropyl alcohol.
70. Install the new heat shield assembly (P/N 62323015 supplied in the Upgrade Kit, re-using the original screws, with the bend-over tabs on the same side as the thermoswitch wiring. After tightening the screws, bend the tabs down to secure the thermoswitch wiring around the upper side of the heat shield as it was previously.
71. See Figure 65. Place the zoom/focus module on a workbench. Cut the cable ties holding the effect cooling fan wiring. Disconnect the fans, making a note of which connectors they were plugged into, then remove the 4 mounting screws from each fan and remove the fans from the zoom/focus module. The fans and mounting screws are no longer required, as new items are supplied in the Upgrade Kit.



**Figure 64**



**Figure 65**



72. See Figure 66. Two new fans (P/N 62222079) and eight new mounting screws (P/N 08070700) are supplied in the Upgrade Kit. The new screws are much shorter than the fan mounting screws you have just removed and must be tightened on the inner flanges (as shown at **A**) of the fan housing, using a screwdriver thin enough to pass through the holes in the outer flanges. Use the new screws to install the 2 new effects cooling fans in place of the old ones. Install both fans with their labels facing inwards as shown in Figure 66 and install the wire retaining clips (P/N 13101010) supplied in the Upgrade Kit as follows:

- one clip on the front top mounting screw **B** of the left-hand side fan, and
- the other wire retaining clip on the rear top mounting screw **C** of the right-hand side fan.

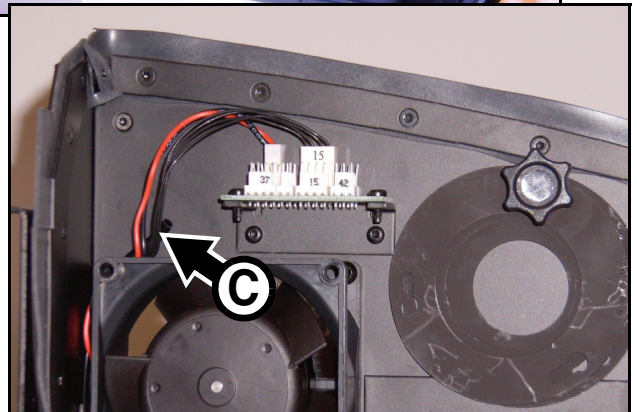
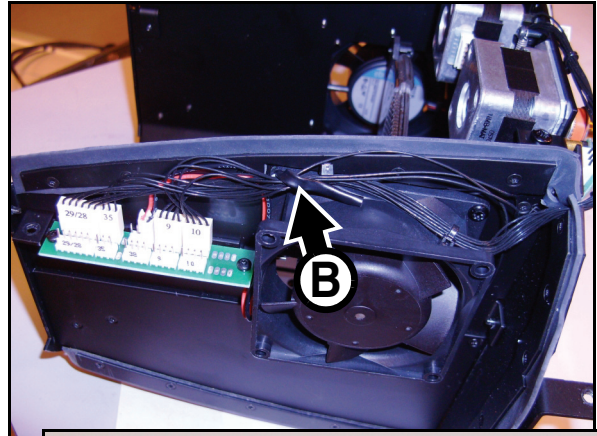
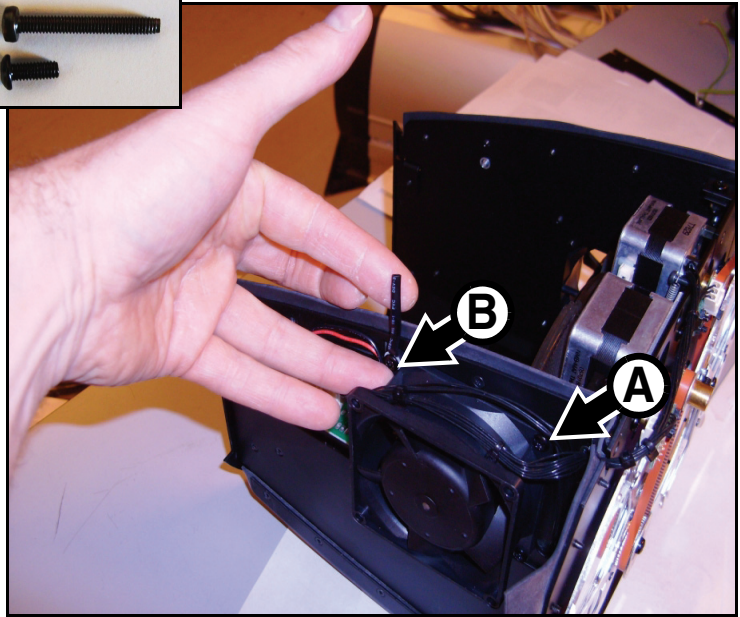
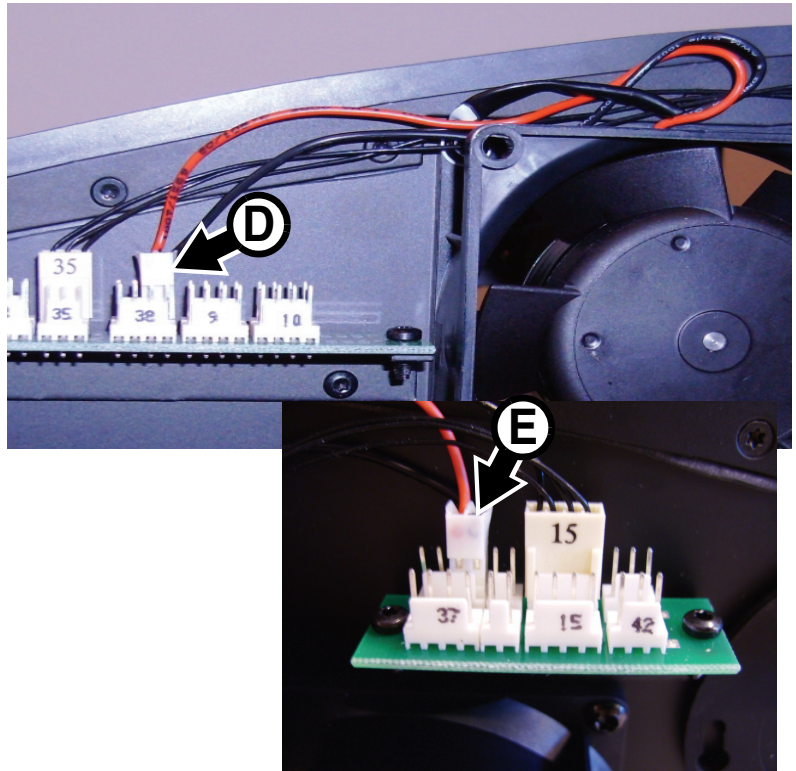


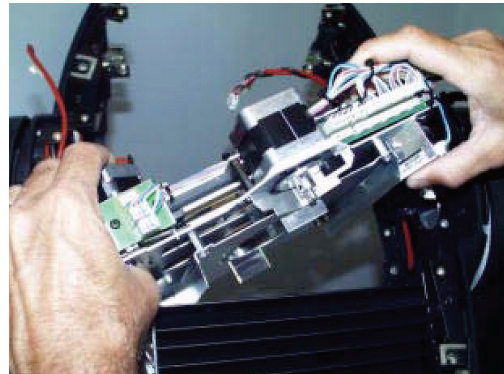
Figure 66

73. See Figure 67. Plug the effects fans into the connectors where the old effects fans were plugged in:
- on the rear two pins **D** of connector 38 on the left-hand side and
  - on the front two pins **E** of connector 37 on the right-hand side of the zoom/focus module.
74. Secure wiring with cable ties and the wire retaining clips shown at **B** and **C** in Figure 66. Make sure that wiring cannot hang in front of fans or come into contact with any moving parts.



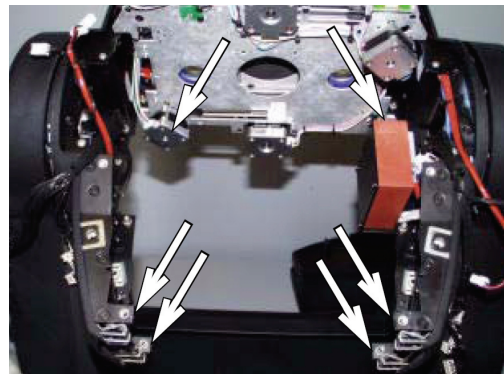
**Figure 67**

75. See Figure 68. Hold the new CMY module (P/N 55205110) supplied with the Upgrade Kit at an angle, with the right-hand side higher and further forward than the left, and lower the module into the chassis. Bring the module square to the chassis, making sure that the mounting screw flaps in the top and bottom of the module locate *over* the plates with the mounting screw holes in the head chassis, and slide the module in towards the back of the head. Align the mounting screw holes and fasten the module into the head at the top and bottom with the four screws you removed in step 47. Do not plug in connectors yet.



**Figure 68**

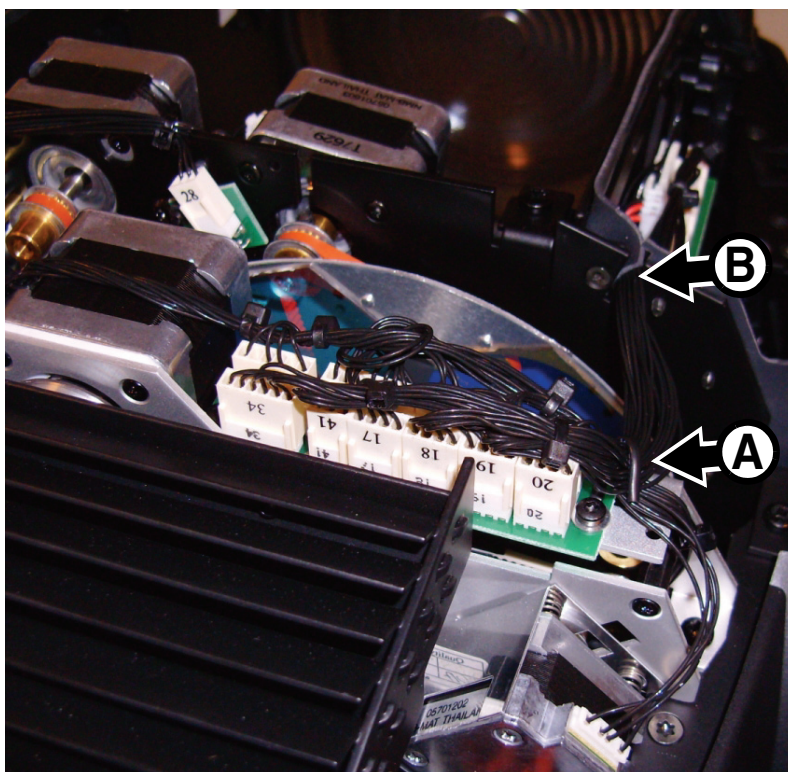
76. See Figure 69. Lower the original zoom/focus module into position in the head, easing it past the 'sticking points' (arrowed) on each side in turn, and secure the module with the four screws you removed in step 43.



**Figure 69**

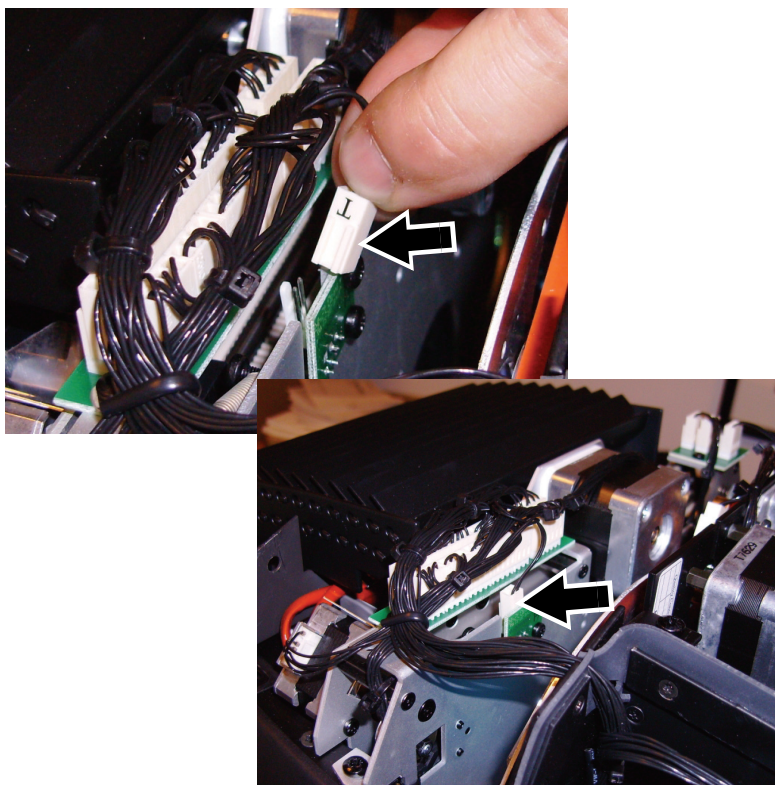


77. See Figure 70. Plug in multi-connectors 34, 41, 17, 18, 19 and 20 on the top of the CMY module on the right-hand side of the head. Secure the main CMY module wireset with the cable retaining clip **A** and pass it through the gap in the rubber shield **B** in the zoom/focus module, ensuring that wiring is held away from the color wheel.



**Figure 70**

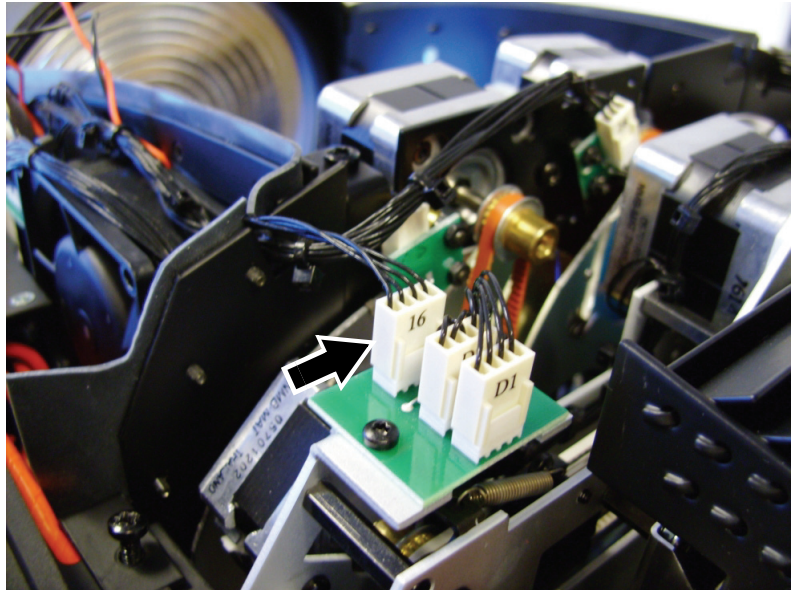
78. See Figure 71. Plug the connector marked T (arrowed) into the two-pin thermoswitch connector below the numbered connectors, facing the color wheel on the front of the CMY module.



**Figure 71**



79. See Figure 72. Plug in connector 16 (arrowed) on the top of the CMY module on the left-hand side of the head.

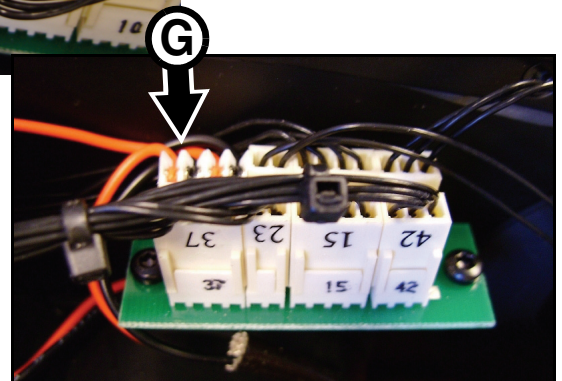
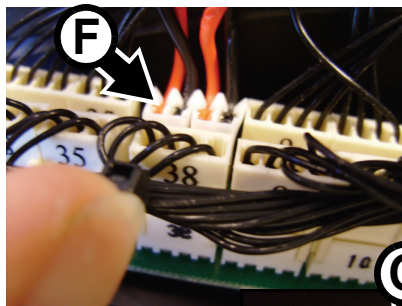


**Figure 72**

80. Plug in connectors 29/28, 35, 38, 9 and 10 on the left-hand side of the zoom/focus module. Secure the wireset for these connectors with the cable retaining clip on the left-hand effects fan, ensuring that wiring is securely held well away from the fan.
81. Plug in connectors 42, 15, 23 and 37 on the right-hand side of the zoom/focus module. Secure the wireset for these connectors with the cable retaining clip on the right-hand effects fan, ensuring that wiring is securely held well away from the fan.

82. See Figure 73. Plug the leads from the lamp cooling fans (see steps 59. and 60.) into the connectors where the old lamp cooling fans were plugged in:

- on the front two pins **F** of connector 38 on the left-hand side of the zoom/focus module, and
- on the rear two pins **G** of connector 37 on the right-hand side of the zoom/focus module.



**Figure 73**

83. Check that all wiring is secure, using cable ties if necessary to make sure that wiring cannot come into contact with fan blades or other moving parts. Make sure also that wiring will not be trapped or crushed when you reinstall covers.

84. Clean or replace air filters, if necessary.
85. Replace all covers and replace the front lens, remembering to attach all safety straps.

**Important! When installing the new lamp, take the precautions listed in the MAC 2000 Wash XB user manual or you may damage the lamp or reduce its operating lifetime.**

86. Install the new 1500 watt lamp (P/N 97010322) supplied in the Upgrade Kit following the instructions in the MAC 2000 Wash XB user manual (P/N 35000219) also supplied in the Upgrade Kit.

## Product label

**Warning!** As soon as you have upgraded the MAC 2000 Wash to the XB model, you must apply the new product label (P/N 33140086) supplied in the Upgrade Kit and illustrated in Figure 74 on top of the serial number label, so that the details of the XB model replace the details of the existing model. Failure to do so will create a significant safety risk, void the product warranty and make the product illegal.

MAC2000 Wash XB	
WATT 1830	Fuse / Fusible T15A/250V
Voltage:	200-240VAC, 50-60Hz
SW 1.8	Rev: -A Lamp/Lampe: HTI 1500Watt

Figure 74

## Safety testing

**Warning!** The two tests described below must be carried out before the upgraded MAC 2000 Wash XB can be considered safe. Do not operate the fixture until it has passed these tests.

### Ground bond test (earth bond test)

68. Open the ballast side base cover. Test the resistance between the ground (earth) conductor in the power cable and each of the two ground leads (see Figure 19) on the chassis plate in turn. If resistance exceeds 0.75 ohms, clean and re-establish all connections and repeat the test until you measure less than 0.75 ohms between the ground conductor in the power cable and each of the two ground leads. Do not proceed to the next test until the fixture passes this test.
69. Reinstall the ballast side cover.

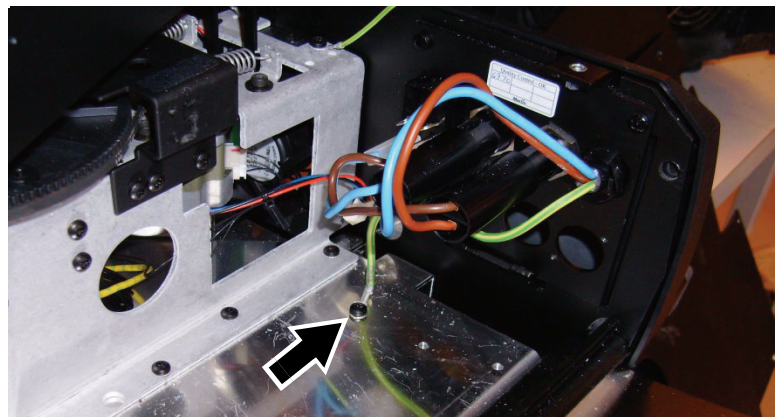
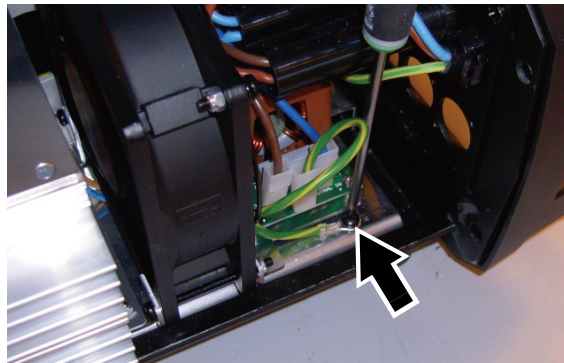


Figure 75

## High-potential dielectric withstand test

**Warning!** *Dangerous voltage. Follow all safety instructions printed in your appliance tester's user manual and on your appliance tester.*

70. Ensure that the fixture's power cable is not connected to power. Temporarily link the live (brown) and neutral (blue) conductors in the fixture's power cable together so that there is electrical continuity between them.
71. Connect one terminal of a PAT (portable appliance tester) device to the combined live and neutral conductors in the fixture's power cable. Connect the other terminal of the PAT device to the ground conductor in the fixture's power cable.
72. Make sure that the fixture's main on/off power switch is set to **ON**.
73. You are about to apply a very dangerous and potentially lethal voltage. Ensure that it is impossible for exposed conductive components in or on the fixture to come into contact with persons, or any conductive surface or substance that persons may touch, during this test.
74. Set the maximum current on your PAT device to 20 mA, then use the PAT device to apply 1500 VAC for a maximum of 1 second to the conductors you have connected it to.
75. If a flashover or arcing occurs, disconnect the PAT device, check all points of the installation, then repeat the test.
76. Separate the live and neutral conductors again before connecting the fixture to normal AC power.

## Lamp adjustment

Before operating an upgraded MAC 2000 Wash XB, carry out lamp adjustment as described in the MAC 2000 Wash XB user manual (P/N 35000219) supplied with the Upgrade Kit.

## Product information

For specifications and other information about the product you have upgraded, please refer to the MAC 2000 Wash XB user manual supplied with the MAC 2000 Wash XB Upgrade Kit. This user manual is also available for download from the Support area of the Martin website at <http://www.martin.com>



---

Martin Professional A/S • Olof Palmes Allé 18 • 8200 Aarhus N • Denmark  
Tel: +45 8740 0000 • Fax +45 8740 0010 • [www.martin.com](http://www.martin.com)