

MH 1 Profile

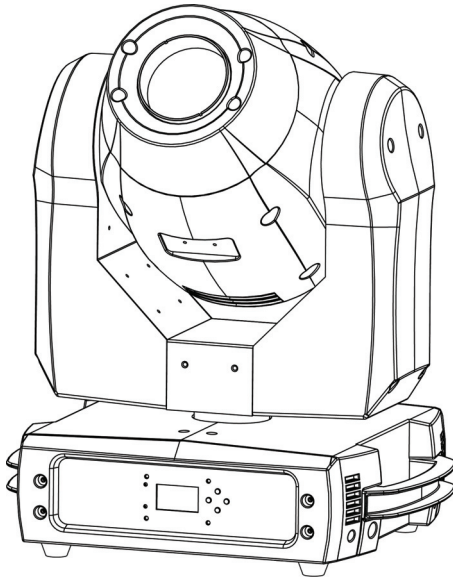

User Manual



Professional Entertainment Technology

© 2013 Martin Professional A/S. Information subject to change without notice. Martin Professional A/S and all affiliated companies disclaim liability for any injury, damage, direct or indirect loss, consequential or economic loss or any other loss occasioned by the use of, inability to use or reliance on the information contained in this manual. The Martin logo, the RUSH by Martin logo, the RUSH by Martin name, the Martin name and all other trademarks in this document pertaining to services or products by Martin Professional A/S or its affiliates and subsidiaries are trademarks owned or licensed by Martin Professional A/S or its affiliates or subsidiaries.

Manual: Revision A

Table of contents

Safety information	5
Introduction	9
Before using the product for the first time	9
Physical installation	10
Fastening the fixture to a flat surface	10
Mounting the fixture on a truss	10
AC power	11
Fixture overview	12
Control data link	13
Tips for reliable data transmission	13
Connecting the DMX data link	14
Fixture setup	15
Using the control menu	15
DMX function settings	15
Show settings	16
Fixture settings	17
Display settings	19
Fixture test	19
Fixture information	20
Reset functions or effects	20
Reset factory default settings	21
Effect home position adjustment	21
Effects	22
Pan & tilt	22
Gobos	22
Iris	23
Motorized focus	23
Prism	23
Strobe effects	23
Electronic dimming	23
Color wheels	23
Maintenance	24
Cleaning	24
Service and repairs	25
DMX protocol	26

Control menus.....	30
Error messages.....	33
Troubleshooting	34
Specifications	36

Safety information



WARNING!

Read the safety precautions in this manual before installing, powering, operating or servicing this product.

The following symbols are used to identify important safety information on the product and in this manual:



Warning!
Safety hazard.
Risk of severe injury or death.



Warning!
LED light emission. Risk of eye injury.



Warning!
Refer to manual before installing, powering or servicing.



Warning!
Hazardous voltage. Risk of lethal or severe electric shock.



Warning!
Hot surfaces and fire hazard.



Avoid looking directly into the LED light source beam and do not view the light output with optical instruments or any device that may concentrate the beam.

This product is for professional use only. It is not for household use. It presents risks of severe injury or death due to fire hazards, electric shock and falls.



Read this manual before installing, powering or servicing the fixture, follow the safety precautions listed below and observe all warnings in this manual and printed on the fixture. Keep this manual for future use. If you have questions about how to operate the fixture safely, please contact your Martin™ dealer or call the Martin 24-hour service hotline at +45 70 200 201.



Protection from electric shock

Shut down power to the fixture before carrying out any installation or maintenance work.

Disconnect the fixture from AC power before removing or installing any cover or part and when not in use.

Ground (earth) the fixture electrically.

Use only a source of AC power that complies with local building and electrical codes and has both overload and ground-fault (earth-fault) protection.

Replace defective fuses with ones of the specified type and rating only.

The voltage and frequency at the power throughput outlet are the same as the voltage and frequency applied to the power inlet. Only connect devices to the power outlet that accept this voltage and frequency.

Before using the fixture, check that all power distribution equipment and cables are in perfect condition and rated for the current requirements of all connected devices.

Isolate the fixture from power immediately if the power plug or any seal, cover, cable, or other component is damaged, defective, deformed, wet or showing signs of overheating. Do not reapply power until repairs have been completed

Do not expose the fixture to rain or moisture.



Protection from burns and fire

Do not operate the fixture if the ambient temperature (T_a) exceeds 40° C (104° F).

The surface of the product casing can reach up to 85° C (185° F) during operation. Avoid contact by persons and materials. Allow the fixture to cool for at least 10 minutes before handling.

Keep flammable materials well away from the fixture. Keep all combustible materials (e.g. fabric, wood, paper) at least 100 mm (4 in.) away from the fixture head.

Ensure that there is free and unobstructed airflow around the fixture. Provide a minimum clearance of 100 mm (4 in.) around fans and air vents.

Do not illuminate surfaces within 200 mm (7.9 ins.) of the fixture.

Do not attempt to bypass thermostatic switches or fuses.

Do not stick filters, masks or other materials onto any optical component.



Protection from injury

Do not look continuously at LEDs from a distance of less than 8.3 meters (27 ft. 3 inches) from the front surface of the fixture without protective eyewear such as shade 4-5 welding goggles. At less than this distance, the LED emission can cause eye injury or irritation. At distances of 8.3 meters (27 ft. 3 inches) and above, light output is harmless to the naked eye provided that

the eye's natural aversion response is not overcome.

Do not look at LEDs with magnifiers, telescopes, binoculars or similar optical instruments that may concentrate the light output.

Ensure that persons are not looking at the LEDs from within 8.3 meters (27 ft. 3 inches) when the product lights up suddenly. This can happen when power is applied, when the product receives a DMX signal, or when certain control menu items are selected.

To minimize the risk of eye irritation or injury, disconnect the fixture from power at all times when the fixture is not in use, and provide well-lit conditions to reduce the pupil diameter of anyone working on or near the fixture.



Fasten the fixture securely to a fixed surface or structure when in use. The fixture is not portable when installed.

Ensure that any supporting structure and/or hardware used can hold at least 10 times the weight of all the devices they support.

If suspending from a rigging structure, fasten the fixture to a rigging clamp. Do not use safety cables as the primary means of support.

If the fixture is installed in a location where it may cause injury or damage if it falls, install a secondary attachment such as a safety cable that is approved by an official body such as TÜV as a safety attachment for the weight that it secures. The safety cable must comply with EN 60598-2-17 Section 17.6.6 and be capable of bearing a static suspended load that is ten times the weight of the fixture and all installed accessories.

Allow enough clearance around the head to ensure that it cannot collide with an object or another fixture when it moves.

Check that all external covers and rigging hardware are securely fastened.

Block access below the work area and work from a stable platform whenever installing, servicing or moving the fixture.

Do not operate the fixture with missing or damaged covers, shields or any optical component.

Do not lift or carry the fixture by its head. Always ensure that the fixture is supported by its base.

In the event of an operating problem, stop using the fixture immediately and disconnect it from power. Do not attempt to use

a fixture that is obviously damaged.

Do not modify the fixture or install other than genuine RUSH by Martin™ parts.

Refer any service operation not described in this manual to a qualified technician.

Introduction

The MH 1 Profile is a small, powerful profile fixture incorporating a single 180 W long-life LED. It provides two gobo wheels, the first with seven rotating gobos and the second with eight fixed gobos. The fixture has two color wheels, each with eight colors (including white), smooth electronic dimming, rotating prism effects, a mechanical focus and iris, as well as strobe effects. The device is extremely rugged, lightweight and compact, and is ideal for touring applications or small fixed installations.

The fixture can be controlled using any DMX-compliant controller. It can also function without DMX control as a standalone device running one of four pre-programmed shows, with the option of sound-activated scene triggering.

The fixture is supplied with this user manual, a 1.5 m (5 ft) power cable (local power plug not included) and two mounting brackets.

Before using the product for the first time

1. Read Safety information on page 5 before installing, powering, operating or servicing the fixture.
2. Unpack and ensure that there is no transportation damage before using the fixture. Never attempt to operate a damaged fixture.
3. If the fixture is not going to be hard-wired to a mains supply, attach a local power plug (not supplied) to the end of the supplied power cable.
4. Before operating, ensure that the voltage and frequency of the power supply match the power requirements of the fixture.
5. Check the Martin Professional website at www.martin.com for the most recent user documentation and technical information about the fixture. RUSH by Martin™ user manual revisions are identified by the revision letter at the bottom of the inside cover.

Note that whenever AC power is applied to the fixture, it will reset all effects and functions to their home positions. The fixture head will move. This process usually takes around 20 seconds.

Physical installation

The fixture is designed for indoor use only and must be used in a dry location with adequate ventilation. Ensure that none of the fixture's ventilation slots are blocked and ensure that the product is fastened to a secure structure or surface.

Fastening the fixture to a flat surface

The fixture can be fastened to a hard fixed flat surface that is oriented at any angle. Ensure that the surface can support at least 10 times the weight of all fixtures and equipment to be installed on it.

Fasten the fixture securely. Do not stand it on a surface or leave it where it can be moved or fall over. Attach a securely anchored safety cable to the fixture if it is installed in any location where it may fall and cause injury or damage if the primary attachment fails.

Mounting the fixture on a truss

The fixture can be clamped to a truss or similar rigging structure in any orientation. When clamping a fixture to a truss:

1. Check that the rigging structure can support at least 10 times the weight of all fixtures and equipment to be installed on it.
2. Block access under the work area.
3. The fixture is supplied with two brackets to which clamps can be attached. Attach these brackets to the base of the fixture and secure using the quarter-turn screws. Turn the quarter-turn screws a full 90° to lock them.
4. Rig the fixture using clamps and hardware suitable for the purpose, such as omega clamps. Working from a stable platform, hang the fixture on the truss. Tighten the rigging clamps and hardware.
5. Secure the fixture against clamp failure with a secondary attachment such as an approved safety cable that is rated for the weight of the fixture.
6. Check that the head will not collide with other fixtures or objects.

AC power



Read Safety information on page 5 before connecting the fixture to AC mains power.



For protection from electric shock, the fixture must be grounded (earthed). The power distribution circuit must be equipped with a fuse or circuit breaker and ground-fault (earth-fault) protection.

Socket outlets or external power switches used to supply the fixture with power must be located near the fixture and easily accessible so that the fixtures can easily be disconnected from power.

Do not insert or remove live Neutrik PowerCon connectors to apply or cut power, as this may cause arcing at the terminals that will damage the connectors.

Do not use an external dimming system to supply power to the fixture, as this may cause damage to the fixture that is not covered by the product warranty.

Use only Neutrik PowerCon cable connectors to connect to power sockets.

Power input and throughput cables must be rated 20 A minimum, have three conductors 1.5 mm² (16 AWG) minimum conductor size and an outer cable diameter of 5 - 15 mm (0.2 - 0.6 in.). Cables must be hard usage type (SJT or equivalent) and heat-resistant to 90° C (194° F) minimum. In the EU the cable must be HAR approved or equivalent. Cables used for power throughput must meet the same specifications as for power input cables.

The fixture can be hard-wired to a building electrical installation if you want to install it permanently, or a power plug that is suitable for the local power outlets can be installed on the power cable.

The fixture has an auto-ranging power supply that accepts AC mains power at 100 – 240 V, 50/60 Hz. Do not apply AC mains power to the fixture at any other voltage than this.

Power can be relayed from one fixture to another device in a daisy-chain via the PowerCon throughput socket. Do not connect devices to power in a chain that will exceed the power and current ratings of any cable or connector used in the chain. Do not connect more than 4 RUSH MH 1 fixtures to power in a chain at 100-120 V. Do not connect more than 8 RUSH MH 1 fixtures to power

at 220-240 V.

Fixture overview

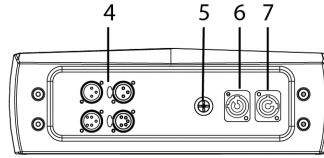
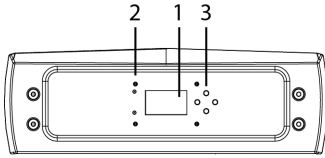

1 - Display

2 - LEDs

The fixture has two LEDs on the front of the base:

DMX	On	DMX input present
SOUND	Flashing	Sound activation

3 – Buttons

MENU	<ul style="list-style-type: none">• Activate the menu mode functions, or• Return to the previous level of the menu structure, or• Hold to exit the menus
DOWN	Go down a menu branch
UP	Go up a menu branch
ENTER	Confirm the selected function

Hold and press the MENU button to exit the menu mode.

4 - DMX XLR input/output sockets

3 and 5-pin XLR sockets are provided for the DMX input and output (throughput).

5 – Fuse

The T 10A fixture fuse can be found under the cover next to the power input/output connectors.

6 - Mains power input

A blue Neutrik PowerCon socket is provided to connect the fixture to mains power.

7 – Mains power throughput

The white Neutrik PowerCon socket can be used to supply power to another fixture.

Control data link

A DMX 512 data link is required in order to control the fixture via DMX. The fixture has 3-pin and 5-pin XLR connectors for DMX data input and output.

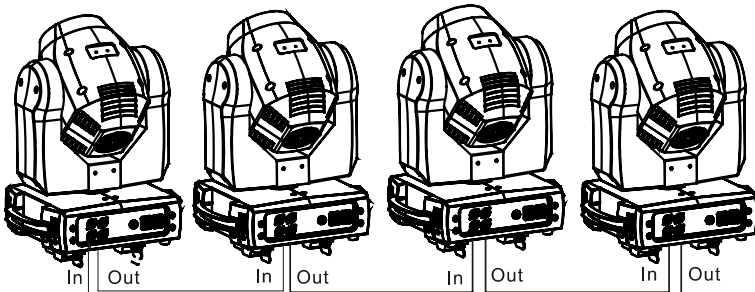

The number of daisy-chained fixtures is limited by the number of DMX channels required by the fixtures in relation to the maximum 512 channels available in one DMX universe. Note that if independent control of a fixture is required, it must have its own DMX channels. Fixtures that are required to behave identically can share the same DMX address and channels. To add more fixtures or groups of fixtures when the above limit is reached, add a DMX universe and another daisy-chained link.

Tips for reliable data transmission

Use shielded twisted-pair cable designed for RS-485 devices: standard microphone cable cannot transmit control data reliably over long runs. 24 AWG cable is suitable for runs up to 300 meters (1000 ft.). Heavier gauge cable and/or an amplifier is recommended for longer runs. The pin-out on all connectors is pin 1 = shield, pin 2 = cold (-), and pin 3 = hot (+). Pins 4 and 5 in the 5-pin XLR connectors are not used in the fixture but are available for possible additional data signals as required by the DMX512-A standard. Standard pin-out is pin 4 = data 2 cold (-) and pin 5 = data 2 hot (+).

To split the link into branches, use a splitter such as the Martin 4-Channel Opto-Isolated RS-485 Splitter/Amplifier. Terminate the link by installing a DMX termination plug in the output socket of the last fixture. The termination plug, which is a male XLR plug with a 120 Ohm, 0.25 W resistor soldered between pins 2 and 3, “soaks up” the control signal so it does not reflect and cause interference. If a splitter is used, terminate each branch of the link.

Connecting the DMX data link

To connect the fixture to data:

1. Connect the DMX data output from the controller to the first fixture's male XLR DMX input connector.
2. Connect the first fixture's DMX output to the DMX input of the next fixture and continue connecting fixtures output to input. Terminate the last fixture on the link with a DMX termination plug.

Fixture setup

This section explains the fixture characteristics that can be set that determine how it can be controlled and will behave. These settings are made using the menus available from the control panel, and are retained, even when the fixture is powered off.

Only the most commonly used menu options for fixture setup are described in this section. A complete map of the control menu structure and brief explanations of their purposes can be found in Control menus on page 30.

Using the control menus

To access the control menus, press the MENU button. Navigate the menu structure using the ENTER, DOWN and UP buttons. Select any required menu option using the ENTER button. To return to a higher level in the menu structure without any change press the MENU button.

To exit the menus, press and hold the MENU button.

DMX function settings

DMX function settings include the DMX address and a DMX value viewer.

DMX addressing

The DMX address, also known as the start channel, is the first channel used to receive instructions from a DMX controller. The fixture can be controlled using signals sent by a DMX controller over 17 channels. Each DMX controlled fixture must have a DMX address set. For example, if a fixture has a DMX address of 10, then it uses channels 10, 11, 12, 13, 14, 15, 16, 17, 18, 19, 20, 21, 22, 23, 24, 25 and 26. The following fixture in the DMX chain could then be set to a DMX address of 27.

For independent control, each fixture must be assigned its own control channels. Two fixtures of the same type may share the same address, if identical behavior is desired. Address sharing can be useful for diagnostic purposes and symmetric control, particularly when combined with the inverse pan and tilt options.

The DMX address is configured using the DMX FUNCTIONS menu in the control panel.

To set the fixture's DMX address:

1. Select DMX FUNCTIONS and press the ENTER button
2. Use the UP and DOWN buttons to select DMX ADDRESS and press the ENTER button to confirm. The present address will blink on the display.
3. Use the UP and DOWN buttons to select a new address.

4. Once the address has been selected, press the ENTER button to set it. Or to return to the higher level of the menu structure without any change press the MENU button again.

Show settings

Show settings determine the behavior of the fixture when it is disconnected from DMX and if, and how, it will run one of the onboard shows.

Offline mode

Offline mode defines what the fixture will do if it loses or is not connected to a DMX signal. There are three options M/S (enter stand-alone Show Mode), HOLD (do nothing), or BLACKOUT.

To set a fixture's offline mode:

1. Select SHOW SETTINGS and press the ENTER button to confirm.
2. Use the DOWN and UP buttons to select OFFLINE MODE and press the ENTER button to confirm.
3. Use the DOWN and UP buttons to select M/S, HOLD, or BLACKOUT.
4. Once the offline mode has been selected, press the ENTER button to set (or, to return to the higher level of the menu structure without any change press the MENU button).

Show settings

Show mode provides four preprogrammed shows. These are not accessible via DMX. Show mode can be combined with music trig sound activation to provide a synchronized light show.

To set a fixture's show mode:

1. Select SHOW SETTINGS and press the ENTER button to confirm.
2. Use the DOWN and UP buttons to select SHOW MODE and press the ENTER button to confirm.
3. Use the DOWN and UP buttons to select SHOW 1, SHOW 2, SHOW 3 or SHOW 4.
4. Once the show has been selected, press the ENTER button to set (or, to return to the higher level of the menu structure without any change press the MENU button).

Setting the focus index for gobo wheels 1 and 2

For the shows, the focus index can be set for each of the two gobo wheels, 1 (rotating gobos) and 2 (fixed gobos).

To set the focus for a gobo wheel:

1. Select SHOW SETTINGS and press the ENTER button to confirm.

2. Use the DOWN and UP buttons to select FOCUS 1 or FOCUS 2 (corresponding to wheel 1 (rotating) or wheel 2 (fixed)) and press the ENTER button to confirm.
3. Use the DOWN and UP buttons to change the focus point from 0...255.
4. Once the level has been selected, press the ENTER button to set it (or, to return to the higher level of the menu structure without any change press the MENU button).

Music trig sound activation

The fixture has a built-in microphone that can be used to synchronize its behavior to the beat of music. When the fixture is not connected to a DMX controller, and is running one of the preprogrammed shows, it can be set to trigger scene changes (effects, color changes and movement) in synchrony with music.

To turn on sound activation:

1. Select SHOW SETTINGS and press the ENTER button to confirm.
2. Use the DOWN and UP buttons to select SOUND TRIGGER and press the ENTER button to confirm.
3. Use the DOWN and UP buttons to select ON (sound activation on) or OFF (sound activation off).
4. Press the ENTER button to set it (or, to return to the higher level of the menu structure without any change press the MENU button).

To adjust the sensitivity of the sound-activation microphone:

1. Select SHOW SETTINGS and press the ENTER button to confirm.
2. Select SOUND SENSIVITY and press the ENTER button to confirm.
3. Use the DOWN and UP buttons to change the microphone sensitivity from 0 ... 100 (low-high).
4. Once the level has been selected, press the ENTER button to set it (or, to return to the higher level of the menu structure without any change press the MENU button).

Fixture settings

Pan and/or tilt inversion

The FIXTURE SETTINGS→PAN INVERSE and TILT INVERSE menus can be used to reverse the direction of pan and/or tilt. These settings are useful for symmetrical effects with multiple fixtures, or when coordinating the movement of fixtures that are floor mounted and rigged upside down.

To adjust the pan inversion settings:

1. Select FIXTURE SETTINGS and press the ENTER button to confirm.
2. Use the DOWN and UP buttons to select PAN INVERSE or TILT INVERSE and press the ENTER button to confirm.
3. Use the DOWN and UP buttons to select the YES (inversion) or NO (normal) mode.
4. Press the ENTER button to confirm (or, to return to the higher level of the menu structure without any change press the MENU button).

Pan/tilt feedback

By default, pan/tilt feedback is enabled. This means that if a pan or tilt position error is detected, the fixture will correct the pan/tilt position.

To deactivate, or activate this function use the FIXTURE SETTINGS→P/T FEEDBACK menu.

Iris inversion

To invert the iris settings:

1. Select FIXTURE SETTINGS and press the ENTER button to confirm.
2. Use the DOWN and UP buttons to select IRIS INVERSE and press the ENTER button to confirm.
3. Use the DOWN and UP buttons to select the YES (inversion) or NO (normal) mode.
4. Press the ENTER button to confirm (or, to return to the higher level of the menu structure without any change press the MENU button).

Blackout during change or movement

The fixture can be set, so that when running a show, blackout is enabled during gobo change, color change, and/or pan and tilt movement. This is switched off by default. To adjust the blackout during show playback settings:

1. Select FIXTURE SETTINGS and press the ENTER button to confirm.
2. Use the DOWN and UP buttons to select BL. O. P/T MOVING, BL. O. COLOR CHANGE, or BL. O: GOBO CHANGE and press the ENTER button to confirm.
3. Use the DOWN and UP buttons to select the YES (blackout during movement or change) or NO (normal) mode.
4. Press the ENTER button to confirm (or, to return to the higher level of the menu structure without any change press the MENU button).

Display settings

Invert display

Inverting the display is useful if the fixture is hung from a truss or from elevation. To invert the display:

1. Select DISPLAY SETTINGS and press the ENTER button to confirm.
2. Use the DOWN and UP buttons to select DISPLAY INVERSE and press the ENTER button to confirm.
3. Use the DOWN and UP buttons to select the YES (invert).
4. Press the ENTER button to confirm (or, to return to the higher level of the menu structure without any change press the MENU button).

Automatically turn off display backlight

By default the display is lit when the power is applied to the fixture. It can be set to automatically dim if the buttons and menus have not been used for a period:

1. Select DISPLAY SETTINGS and press the ENTER button to confirm.
2. Use the DOWN and UP buttons to select BACKLIGHT AUTO OFF and press the ENTER button to confirm.
3. Use the DOWN and UP buttons to select the YES.
4. Press the ENTER button to confirm (or, to return to the higher level of the menu structure without any change press the MENU button).

Adjust backlight brightness

The brightness of the control panel display can be adjusted:

1. Select DISPLAY SETTINGS and press the ENTER button to confirm.
2. Use the DOWN and UP buttons to select BACKLIGHT BRIGHTNESS and press the ENTER button to confirm.
3. Use the DOWN and UP buttons to set a level from 1 to 10.
4. Press the ENTER button to confirm (or, to return to the higher level of the menu structure without any change press the MENU button).

Fixture test

Automatic tests of all functions, or manual test of individual functions can be run from the control menus.

Auto test

To perform a complete test of all of the fixture functions:

1. Select FIXTURE TEST and press the ENTER button to confirm.

2. Use the DOWN and UP buttons to select AUTO TEST and press the ENTER button to confirm. The automatic test will run.

Manual test

Fixture functions can be tested or controlled manually:

1. Select FIXTURE TEST and press the ENTER button to confirm.
2. Use the DOWN and UP buttons to select MANUAL TEST and press the ENTER button to confirm.
3. To return to a higher level of the menu press the MENU button again.

Fixture information

Fixture operating hours counter

To see how many hours the fixture has been used:

1. Select FIXTURE INFORMATION and press the ENTER button to confirm.
2. Use the DOWN and UP buttons to select FIXTURE USE HOUR and press the ENTER button to confirm. The number of hours will be shown.

Lamp operating hours counter

This counter can be reset, so it can be used to monitor when a service is required. The counter is available under the FIXTURE INFORMATION→LIGHT USE HOUR menu.

Firmware version

To see what software version is installed in the fixture:

3. Select FIXTURE INFORMATION and press the ENTER button to confirm.
4. Use the DOWN and UP buttons to select FIRMWARE VERSION and press the ENTER button to confirm. The firmware version will be shown.

Reset functions or effects

The various effects—pan, tilt color, gobos, iris, focus, prism—or all effects, can be manually reset to their home positions:

1. Select RESET FUNCTIONS and press the ENTER button to confirm.
2. Use the DOWN and UP buttons to select the function or effect that is to be reset. Press the ENTER button.
3. Use the DOWN and UP buttons to select YES and press the ENTER button to confirm (or to return to a higher level of the menu structure without any change press the MENU button).

Reset factory default settings

The fixture's default settings can be restored using SPECIAL FUNCTIONS→FACTORY SETTINGS.

Effect home position adjustment

The various effects—pan, tilt color wheels, gobo wheels, gobos, iris, focus, and prism—can lose or move out of their indexed home position. To reset any of these:

1. In the menu structure, hold the ENTER button down for at least 3 seconds to enter the OFFSET MENU.
2. Use the DOWN and UP buttons to choose the function that needs to be adjusted. Press the ENTER button to select it.
3. The present indexed home position will appear blinking in the display. Use the DOWN and UP buttons to adjust the home position of the function or effect.
4. Once the correct position has been reached, press the ENTER button to set this (or to return to a higher level of the menu structure without any change press the MENU button).

Effects

This section describes DMX-controllable effects that require particular explanation. See DMX protocol on page 26 for a full list of the DMX channels and values required to control the different effects.

Pan & tilt

The fixture's moving head can be panned through 540° and tilted through 270° using coarse or fine control channels. The fixture can be set to automatically blackout during pan and tilt movement.

The fixture incorporates pan and tilt feedback, so that if a pan or tilt position error is detected, the shutter closes and the fixture resets to the correct pan & tilt position. This can be disabled if not required (see Control menus on page 30).

Gobos

The fixture contains two gobo wheels:

GOBO WHEEL 1:



GOBO WHEEL 2:



Any gobo can be projected statically, or the wheels can be rotated, both clockwise and counter-clockwise. Individual gobos on wheel 1 can be rotated both clockwise and counter-clockwise, and a gobo shake function is available. The fixture can be set to automatically blackout during gobo changes.

The rotating gobos can be replaced with your own metal gobos in the following size:

Gobo size: 26.8 mm (1.1 in.)

Gobo image size: 22 mm (0.87 in.)

To replace a gobo:

1. Ensure that the fixture is detached from power and is cool.
2. Remove the fixture head cover using a Phillips screwdriver.
3. The rotating gobos sit in blades that slot into the rotating gobo wheel. Lift out the blade that contains the gobo that is to be replaced.

4. The gobo is held in place on the blade by a wire clip. Remove the clip, replace the gobo, replace the wire clip and replace the blade in the rotating gobo wheel.
5. Replace the head covers and be ready for the head to move during a reset before reapplying power.

Iris

The fixture provides an adjustable iris, allowing the size of the projected beam to be adjusted.

Motorized focus

The focus of gobos projected onto a surface can be adjusted.

Prism

The fixture incorporates a prism that can be inserted into the beam, providing split effects. The prism can be set to an indexed position or rotated clockwise or counter-clockwise.

Strobe effects

The strobe effects provide instant open and blackout, variable speed regular and random strobe.

Electronic dimming

Overall intensity can be adjusted 0-100%.

Color wheels

The fixture incorporates two color wheels, each with eight colors (including open/white). These can be individually selected, or the wheels can be rotated at varying speeds, both clockwise and counter-clockwise. The fixture can be set to automatically blackout during color changes.

Maintenance



Read Safety information on page 5 before maintaining the fixture. Always comply with the safety instructions.

Refer any service operation not described in this user manual to a qualified service technician.

Excessive dust, smoke fluid, and particle buildup degrades performance, causes overheating and will damage the fixture. Damage caused by inadequate cleaning or maintenance is not covered by the product warranty.

Always disconnect mains power before cleaning or servicing the fixture.

Fixtures must be serviced in an area where there is no risk of anyone being injured by failing parts, tools or other materials.

Cleaning

The cleaning of external optical lenses must be carried out periodically to optimize light output. Cleaning schedules for lighting fixtures vary greatly depending on the operating environment. It is therefore impossible to specify precise cleaning intervals for the fixture. Environmental factors that may result in a need for frequent cleaning include:

- Use of smoke or fog machines.
- High airflow rates (near air conditioning vents, for example).
- Presence of cigarette smoke.
- Airborne dust (from stage effects, building structures and fittings or the natural environment at outdoor events, for example).

If one or more of these factors is present, inspect fixtures within their first 100 hours of operation to see whether cleaning is necessary. Check again at frequent intervals. This procedure will allow you to assess cleaning requirements in your particular situation. If in doubt, consult your RUSH by Martin dealer about a suitable maintenance schedule.

Use gentle pressure only when cleaning, and work in a clean, well-lit area. Do not use any product that contains solvents or abrasives, as these can cause surface damage.

To clean the fixture:

1. Disconnect the fixture from power and allow it to cool for at least 10 minutes.
2. Vacuum or gently blow away dust and loose particles from the outside of the fixture and the air vents at the back and sides of the head and in the base with low-pressure compressed air.
3. Clean the LED lenses by wiping gently with a soft, clean lint-free cloth moistened with a weak detergent solution. Do not rub the surface hard: lift particles off with a soft repeated press. Dry with a soft, clean, lint-free cloth or low-pressure compressed air. Remove stuck particles with an unscented tissue or cotton swab moistened with glass cleaner or distilled water.
4. Check that the fixture is dry before reapplying power.

Service and repairs





















There are no user serviceable parts inside the fixture. Do not open the housing.









Never try to repair the fixture by yourself as this may result in damage, malfunction and it may potentially void your product warranty. The equipment must only be serviced or repaired by an authorized RUSH by Martin service technician.

Installation, on-site service and maintenance can be provided worldwide by the Martin Professional Global Service organization and its approved agents, giving owners access to Martin's expertise and product knowledge in a partnership that will ensure the highest level of performance throughout the product's lifetime. Please contact your RUSH by Martin supplier for details.

DMX protocol

Chan.	Value	Function
1	1-255	Pan 0°-540°
2	1-255	Pan (fine control)
3	1-255	Tilt 0°-270°
4	1-255	Tilt (fine control)
5	1-254	Pan/tilt speed, fast- slow
	255	Pan/tilt speed, fast
6	0-255	Dimmer 0-100%
7	Strobe	
	0-7	Off
	8-15	Open
	16-131	Strobe, slow-fast
	132-139	Open
	140-181	Fast close, slow open
	182-189	Open
	190-231	Slow close, fast open
	232-239	Open
	240-247	Random strobe
248-255	Open	
8	Color wheel 1	
	0-7	Color 1 – Open
	8-15	Color 2 – Orange
	16-23	Color 3 – Blue
	24-31	Color 4 – Magenta
	32-39	Color 5 – Red
	40-47	Color 6 – Green
	48-55	Color 7 – Light blue
	56-63	Color 8 – Yellow
	64-127	Indexing
	128-189	Clockwise, fast-slow
	190-193	Stop
194-255	Counter-clockwise, slow-fast	
9	Color wheel 2	
	0-7	Color 1 – Open
	8-15	Color 2 – Off white
	16-23	Color 3 – Pastel pink
	24-31	Color 4 – Mint green

Chan.	Value	Function														
	32-39	Color 5 – Dark blue														
	40-47	Color 6 – Golden yellow														
	48-55	Color 7 – Pink														
	56-63	Color 8 – Sky blue														
	64-127	Indexing														
	128-189	Clockwise, fast-slow														
	190-193	Stop														
	194-255	Counter-clockwise, slow-fast														
10	Gobo wheel 1 (rotating gobos)															
	<table border="0" style="width: 100%; text-align: center;"> <tr> <td>Gobo1</td> <td>Gobo2</td> <td>Gobo3</td> <td>Gobo4</td> <td>Gobo5</td> <td>Gobo6</td> <td>Gobo7</td> </tr> <tr> <td></td> <td></td> <td></td> <td></td> <td></td> <td></td> <td></td> </tr> </table>		Gobo1	Gobo2	Gobo3	Gobo4	Gobo5	Gobo6	Gobo7							
	Gobo1	Gobo2	Gobo3	Gobo4	Gobo5	Gobo6	Gobo7									
																
		0-7	Open													
		8-15	Gobo 1													
		16-23	Gobo 2													
		24-31	Gobo 3													
		32-39	Gobo 4													
		40-47	Gobo 5													
		48-55	Gobo 6													
		56-63	Gobo 7													
		64-73	Gobo 1 shake													
		74-82	Gobo 2 shake													
		83-91	Gobo 3 shake													
		92-100	Gobo 4 shake													
		101-109	Gobo 5 shake													
		110-118	Gobo 6 shake													
		119-127	Gobo 7 shake													
		128-189	Wheel rotation, clockwise, fast-slow													
	190-193	Stop														
	194-255	Wheel rotation, counter clockwise, slow-fast														
11	Gobo rotation (wheel 1)															
	0-127	Indexed position, 0°-360°														
	128-189	Clockwise rotation, fast-slow														
	190-193	Stop														
	194-255	Counter-clockwise rotation, slow-fast														

12	Gobo wheel 2 (fixed gobos)							
	Gobo1	Gobo2	Gobo3	Gobo4	Gobo5	Gobo6	Gobo7	Gobo8
								
	0-7		Open					
	8-14		Gobo 1					
	15-21		Gobo 2					
	22-28		Gobo 3					
	29-35		Gobo 4					
	36-42		Gobo 5					
	43-49		Gobo 6					
	50-56		Gobo 7					
	57-63		Gobo 8					
	64-71		Gobo 1 shake					
	72-79		Gobo 2 shake					
	80-87		Gobo 3 shake					
	88-95		Gobo 4 shake					
	96-103		Gobo 5 shake					
	104-111		Gobo 6 shake					
	112-119		Gobo 7 shake					
	120-127		Gobo 8 shake					
	128-189		Wheel rotation, counter clockwise, fast-slow					
	190-193		Stop					
	194-255		Wheel rotation, clockwise, slow-fast					
13	Prism							
	0-127		No effect					
	128-255		Prism effect					
14	Prism rotation							
	0-127		Indexed position 0°-360°					
	128-189		Clockwise rotation, fast-slow					
	190-193		Stop					
	194-255		Counter-clockwise rotation, slow-fast					
15	0-255		Iris, maximum-minimum					
16	0-255		Focus, close-distant					
17	Function							
	0-69		No function					
	70-79		Blackout during pan & tilt					
	80-89		Disable blackout during pan & tilt					
	90-99		Blackout during color change					
	100-109		Disable blackout during color change					
	110-119		Blackout during gobo change					

	120-129	Disable blackout during gobo change
	130-139	No function
	140-149	Pan/tilt reset
	150-159	Color reset
	160-169	Gobo reset
	170-179	No function
	180-189	Focus reset
	190-199	No function
	200-209	Reset all
	210-219	Blackout during pan/tilt or color/gobo change
	220-229	Disable blackout during pan/tilt or color/gobo change
	230-255	No function

Control menus

To access the control menus, press the MENU button. Use the UP and DOWN buttons to navigate the menus. Select any required menu option using the ENTER button. For more information, see Using the control menus on page 15.

Default fixture settings are shown in **bold**.

Menu	Sub-menu	Setting/value	Explanation	
DMX Functions	DMX Address	1 –496	Fixture DMX address setting	
	Mode	17 channel		
	View DMX Value	View values received on DMX channels		
Show settings	Offline Mode	M/S	When no DMX signal, go to Show Mode	
		Hold	When no DMX signal, do nothing (hold)	
		Blackout	When no DMX signal, black out	
	Show Mode	Show 1	Pre-programmed show 1	
		Show 2	Pre-programmed show 2	
		Show 3	Pre-programmed show 3	
		Show 4	Pre-programmed show 4	
	Focus 1	0-255	Focus setting for gobo wheel 1 (rotating gobos)	
	Focus 2	0-255	Focus setting for gobo wheel 2 (fixed gobos)	
	Sound Trigger	Off	Sound activation off	
		On	Sound activation on	
Sound Sensitivity	0-100	Sound activation microphone sensitivity (low-high)		

Fixture settings	Pan Inverse	Yes/No	Inverse pan direction
	Tilt Inverse	Yes/No	Invert tilt direction
	P/T Feedback	Yes/No	If pan or tilt position error is detected, fixture corrects pan/tilt position
	Iris Inverse	Yes/No	Invert iris action
	BI.O. P/T Moving	Yes/No	Blackout during pan/tilt movement
	BI.O. Color Change	Yes/No	Blackout during color change
Display settings	BI.O. Gobo Change	Yes/No	Blackout during gobo change
	Display inverse	Yes/No	Invert control panel display
	Backlight Auto Off	Yes/No	Automatically turn off display backlight when not in use.
	Backlight Brightness	1-10	Display panel backlight brightness
Fixture Test	Temperature Unit	°C/°F	Celsius / Fahrenheit
	Auto Test		Automatic test of all functions
Fixture Information	Manual Test		Manually test all functions
	Fixture Use Hour		Fixture operating hour counter
	Light Use Hour	Exit	Exit without resetting time
		Reset Time	Reset lamp hour use counter
	Firmware Version		Currently installed firmware version
Reset Functions	Pan & Tilt	Yes/No	
	Color	Yes/No	
	Gobo	Yes/No	
	Prism	Yes/No	
	Iris	Yes/No	
	Focus	Yes/No	
	All	Yes/No	
Special Functions	Factory Settings	Yes/No	Return all settings to factory defaults

Offset menu

The Offset menu is used to adjust the home position of the various effects.

To access the Offset menu, press the MENU button to enter the menu structure and then press and hold the ENTER button for three seconds.

Menu	Sub-menu	Setting	Explanation
Offset	Pan	-128...127	
	Tilt	-128...127	
	Color 1	-128...127	
	Color 2	-128...127	
	Gobo 1	-128...127	Wheel with rotating gobos
	Gobo 1 R	-128...127	Rotating gobos
	Gobo 2	-128...127	Wheel with fixed gobos
	Iris	0-255	
	Prism	0-255	
	R prism	-128...127	
	Focus	0-255	

Error messages

Error:	Appears when:
Lamp Startup Fail	No lamp or some wires are damaged.
Temperature Sense Error	Temperature sensor on the PCB is damaged.
Lamp Too Hot Power Off	Temperature is detected higher than 110° C. Ensure that the fixture is adequately ventilated. The fans or temperature sensor might be damaged (contact Martin support).
Lamp Too Hot Low Power	Temperature is detected higher than 105° C. The fixture runs at a low power level.
Maintenance Fixture	Fixture maintenance is required (based on the countdown timer). Maintain the fixture, and then reset the countdown timer using the menus.
Lamp On Over 700 Hour	The fixture has been on for more than 700 hours. Turn the fixture off.
Memory Initial Fail	Damaged memory IC (contact Martin support).
CPU-B Error, CPU-C Error, CPU-D Error	Board P.C or fixture wiring is damaged (contact Martin support).
Pan Reset Error Pan Encode Error Tilt Reset Error Tilt Encode Error Shutter Reset Fail Dimmer Reset Fail Color Reset Fail Gobo Reset Fail	These can appear when powering on or resetting the fixture and can indicate damage to sensors or components (contact Martin support).

Troubleshooting

This section describes a few common problems that may occur during operation and provides some suggestions for easy troubleshooting:

Symptom	Potential cause	Remedies
No light from fixture, or fans not working.	Power supply issue, such as blown fuse, faulty connector or damaged cable.	<p>Ensure that the mains supply is connected and supplying power to the fixture.</p> <p>Ensure that the fixture's power-on LED is lit.</p> <p>Check all power connections and cables.</p> <p>Replace the fixture fuse.</p>
The fixture does not react to the beat of music.	<p>Sound activation disabled.</p> <p>Sound activation sensitivity too low for music source.</p>	<p>Ensure that the fixture is not connected to a DMX signal.</p> <p>Adjust sound activation microphone sensitivity</p> <p>Tap the microphone to ensure that it is functioning. The fixture should react when in sound activation mode.</p>
One of the control channels is unresponsive or only responds intermittently.	Damaged step motor or cable connection between the head and body.	Contact your RUSH by Martin authorized distributor or service center for assistance.

Symptom	Potential cause	Remedies
<p>Fixture does not respond to DMX control.</p>	<p>Fault in the DMX network due to connector or cable damaged, or incorrect DMX addressing, or potential interference from proximity to a high voltage installation.</p>	<p>Check that the fixture DMX LED is on, and if not, check all DMX cables and connections to ensure the integrity of the physical network.</p> <p>Ensure that the DMX network is terminated.</p> <p>Check that the components in the DMX network all use standard DMX polarity.</p> <p>Ensure that the fixture is set to the correct DMX address, one that matches that set on the DMX control device.</p> <p>Check the pins on the connectors from the previous fixture in the DMX network.</p> <p>Attempt to control the fixture with another DMX control device.</p> <p>Move the fixture if it is being operated very close to an unshielded high-voltage installation.</p>

Specifications

Physical

Weight 18 kg (39.7 lbs.)

Dimensions 418 x 588 x 328 mm (16.5 x 23.1 x 12.9 in.)

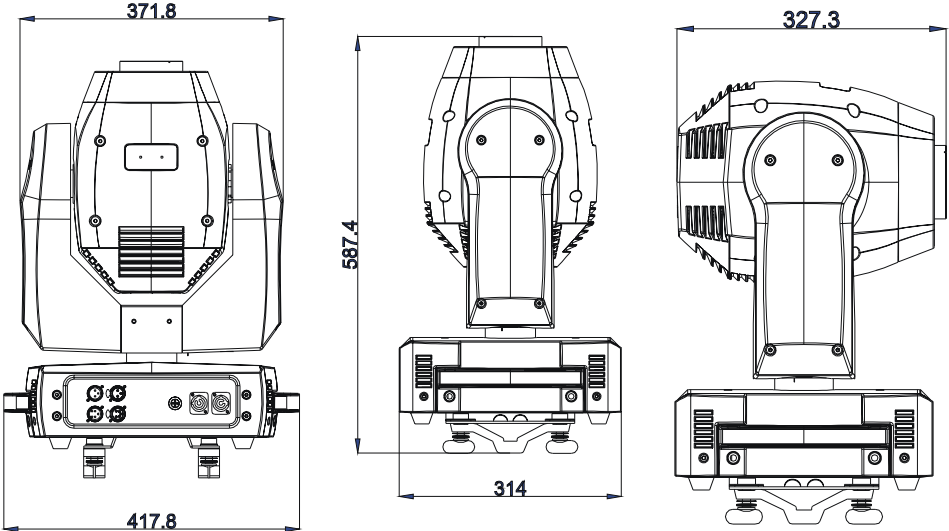

Dynamic Effects

Color wheel 1 7 colors plus open, rotation with variable direction and speed

Color wheel 2 7 colors (incl. 1 x UV, 2 x CTC) plus open, rotation with variable direction and speed

GOBO WHEEL 1:



GOBO WHEEL 2:

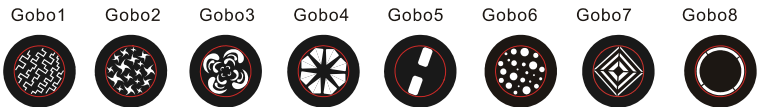

Rotating gobo wheel 7 gobos plus open, wheel rotation, gobo indexing, rotation and shake

Static gobo wheel 8 gobos plus open, wheel rotation and shake

Electronic 'shutter' effect.....Strobe effect, pulse effects, instant
 open and blackout
 Prism..... Indexing and rotation with variable direction and speed
 Iris Motorized
 Focus Motorized
 Electronic dimming 0 - 100%, four dimming curve options
 Pan.....540°, coarse & fine control and speed
 Tilt270°,coarse & fine control and speed

Control and Programming

Control options..... DMX, stand-alone
 DMX channels..... 17
 Stand-alone trigger options.....Music trig, auto trig
 Stand-alone sequences4 pre-programmed shows
 Stand-alone memory20 scenes
 Music trig sensitivity..... Adjustable
 Setting and addressing Control panel with backlit LCD display
 DMX compliance..... USITT DMX512/1990

Optics and Photometric Data

Light source 1 x 180 W LED engine
 Minimum LED lifetime 50 000 hours (to >70% luminous output)*
 Rotating gobo size26.8 mm (1.1 in.)
 Rotating gobo image size22 mm (0.87 in.)
 *Manufacturer's figure obtained under manufacturer's test conditions

Construction

Color Black
 Housing.....High-impact flame-retardant thermoplastic
 Protection rating.....IP 20

Installation

Mounting points..... Two quarter-turn brackets for rigging clamps
 Location Indoor use only, must be fastened to surface or structure
 Orientation Any

Connections

AC power inputNeutrik PowerCon
 AC power throughput.....Neutrik PowerCon
 DMX data in/out 3-pin & 5-pin locking XLR

Electrical

AC power 100-240 V, 50/60 Hz
 Power consumption 350 W
 Fuse T10A
 Power supply unit.....Auto-ranging electronic switch mode

Thermal

Cooling Forced air
Maximum ambient temperature (T_a max.) 40° C (104° F)
Minimum ambient temperature (T_a min) 0° C (32° F)

Included Items

Power cable, 1.5 m, without mains plug

Specifications are subject to change without notice. For the latest product specifications, see www.martin.com

	<p>Disposing of this product</p> <p>RUSH by Martin™ products are supplied in compliance with Directive 2002/96/EC of the European Parliament and of the Council of the European Union on WEEE (Waste Electrical and Electronic Equipment), as amended by Directive 2003/108/EC, where applicable. Help preserve the environment! Ensure that this product is recycled at the end of its life. Your supplier can give details of local arrangements for the disposal of RUSH by Martin products</p>
--	---



Innovation • Quality • Performance