

martinarchitectural

Cyclo IP65 series



user manual

Martin

Dimensions

Measurements are in millimeters

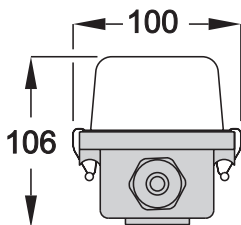
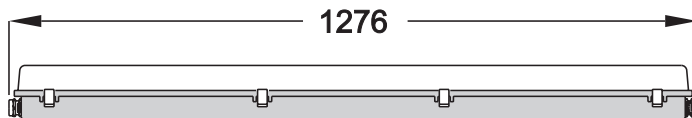

**Cyclo IP65 02 and
28 W tube Cyclo IP65 03**

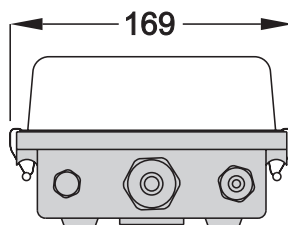

**Cyclo IP65 04 and
54 W tube Cyclo IP65 03**

The logo for Martin Professional, featuring the word 'Martin' in a bold, sans-serif font with a stylized arrowhead pointing upwards and to the right above the letter 'i'.

© 2005-2006 Martin Professional A/S, Denmark.

All rights reserved. No part of this manual may be reproduced, in any form or by any means, without permission in writing from Martin Professional A/S, Denmark. Information subject to change without notice. Martin Professional A/S and all affiliated companies disclaim liability for any injury, damage, direct or indirect loss, consequential or economic loss or any other loss occasioned by the use of, inability to use or reliance on the information contained in this manual.

Printed in Denmark.

P/N 35000170, Rev. B

Contents

Product overview	4
Introduction	5
Safety information	6
Installation	7
Included items	7
Disassembly for access during installation	8
Mounting	9
AC power	10
Linking luminaires for DMX and master-slave operation	14
Linking luminaires for analog dimmer operation	20
Reassembly after installation	21
Burning in fluorescent tubes	22
Avoiding condensation and humidity	22
Operation in extreme ambient temperatures	23
Stand-alone operation	24
Stand-alone operation settings	26
Single stand-alone operation	27
Master/slave stand-alone operation	27
DMX-controlled operation	31
DMX control functions	31
Service	32
Tube removal and replacement	32
Main fuse replacement	34
Cleaning	34
Troubleshooting	35
DMX protocols	36
Cyclo IP65 Specifications	38

Product overview

(Cyclo IP65 04 illustrated)

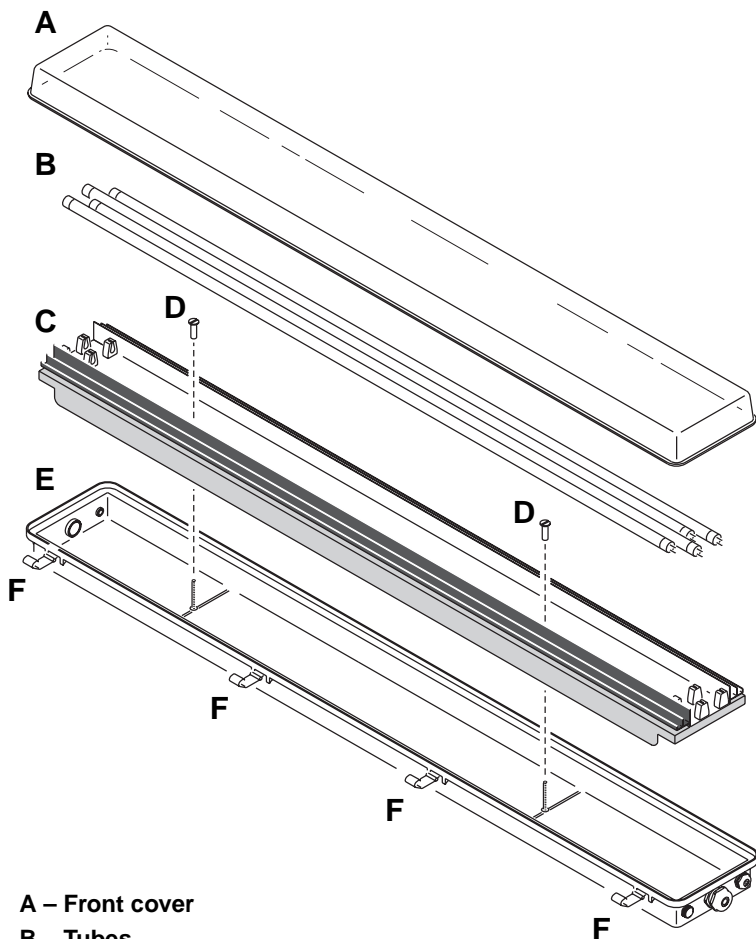

- A – Front cover**
- B – Tubes**
- C – Lamp module**
- D – Lamp module retaining screws**
- E – Housing**
- F – Front cover retaining clips**

Introduction

Thank you for selecting a luminaire from the Martin Architectural Cyclo IP65 series. The Cyclo IP65 is a dynamic, fluorescent tube-based color-changing luminaire that can be controlled via DMX or an analog dimmer. DMX models can also be programmed to run stand-alone light shows, alone or in synchronized groups.

The Cyclo IP65 is designed for dynamic illumination of walls and surfaces. Dimmable T5 fluorescent tubes combine high efficiency, bright color and long lamp life. Luminaires can be surface-mounted or mounted on an adjustable bracket (available as an accessory) that can be tilted through 90°.

All models are dustproof and protected from splashes and low-pressure water jets to IP65. A self-purging humidity valve eliminates condensation. Luminaires can start and operate with tubes dimmed to 1% light output in ambient temperatures as low as -20° C (-4° F).

Luminaires in the Cyclo IP65 series feature combinations of the following options:

Tube options

- 02 models with two white 28 W T5 tubes rated 2700 K and 6000 K, allowing color temperature control from warm to daylight white.
- 03 models with red, green and blue T5 tubes, allowing RGB additive color mixing. Cyclo IP65 03 models are available in 28 W or 54 W (HO) tube variants.
- 04 models with red, green, blue and 4000 K cool white 28 W T5 tubes, allowing controllable RGB additive color mixing as well as color temperature control with enhanced light output from the white tube.

Control options

- DMX models, offering full 0 - 100% intensity control of all tubes via a standard DMX lighting controller.
- Analog dimmer models, offering full 0 - 100% intensity control of all tubes via a 0 - 10 V analog dimmer.

Front cover options

- Clear front cover models (product code C).
- Opal front cover models (product code O).

Front covers are interchangeable and available as accessories.

Power options

- EU models: 198 - 250 VAC, 50/60 Hz.

Important! *Read this manual before attempting to install this product!*

The most recent version of this user manual is available from the Support area of <http://www.martin-architectural.com>

Safety information

Warning! *This product is for professional use only. It is not for household use.*

This product presents risks of lethal or severe injury due to fire and heat, electric shock and falls. **Read this manual** before powering or installing this luminaire, follow the safety precautions listed below, and observe all warnings in this manual and on the luminaire. If you have any questions about how to operate this luminaire safely, contact your Martin dealer or call the Martin 24-hour service hotline on +45 70 200 201.

Protection from electric shock

- Disconnect the luminaire from AC power before removing or installing a tube or any part, and when not in use.
- Always ground (earth) the luminaire electrically.
- Use only a source of AC power that complies with local building and electrical codes and has both overload and ground (earth) fault protection.
- Do not operate the luminaire if any cover or component is cracked, deformed or damaged in any way.
- Refer all service not described in this manual to a Martin service technician.

Protection from burns and fire

- Provide a minimum clearance of 25 mm (1 inch) around the luminaire.
- Never place filters or other materials over the polycarbonate front cover.
- Do not modify the luminaire or install other than genuine Martin parts.
- Do not operate the luminaire if the ambient temperature (T_a) exceeds 40° C (104° F).

Protection from injury due to falls

- Ensure that all components and installation fittings are securely fastened.
- Ensure that all supporting structures, surfaces and fasteners can bear the weight of all luminaires installed.
- Block access below the work area whenever installing, servicing or removing the luminaire.

Installation

This section describes in general terms how to install the luminaire, including how to connect it to power and analog dimmer or control data cables, and how to set it up for DMX control or stand-alone operation. These procedures must be performed by qualified professionals.

Luminaires have to be opened and the lamp module removed during installation, so it will save time if you carry out all the following tasks on each luminaire in one operation:

- Mounting the luminaire.
- Connecting power cables.
- Connecting either DMX or analog dimmer control cables, depending on model.
- Setting DMX addresses or stand-alone programs on DMX models.

We recommend that you read the Installation section of this manual and familiarize yourself with the procedures involved before starting to install luminaires. If you are not familiar with DMX, pay particular attention to the section on setting DMX addresses.

Included items

Depending on model, Cyclo IP65 luminaires are supplied with the following items besides this user manual:

DMX models

- Osram T5 fluorescent tubes (installed)
- 2 x M25 metal IP68 cable glands for AC power cable entry (designed to accept cable Ø 8-12 mm / Ø 0.31-0.47 in.)
- 2 x M16 metal IP68 cable glands for control cable entry (designed to accept cable Ø 7-10 mm / Ø 0.28-0.39 in.)
- 2 x M25 metal blanking plugs for power cable entry holes
- 2 x M16 metal blanking plugs for control cable entry holes
- 2 x rubber sealing washers for mounting screws

Analog dimmer models

- Osram T5 fluorescent tubes (installed)

- 2 x M25 polyamide cable glands for AC power cable entry (designed to accept cable Ø 7-14mm / Ø 0.28-0.55 in.)
- 2 x M16 polyamide cable glands for control cable entry (designed to accept cable Ø 5-9mm / Ø 0.20-0.35 in.)
- 2 x M25 polyamide blanking plugs for power cable entry holes
- 2 x M16 polyamide blanking plugs for control cable entry holes
- 2 x rubber sealing washers for mounting screws

Cable glands

If power or control cable is used that is not within the diameters specified above, new cable glands that match cable diameter must be obtained from an electrical supplier. Cable glands must also be replaced with new items if cable in an existing installation is replaced with cable of a different diameter. Replacement glands must have the following characteristics:

Temperature range: -20° to +70°C or better

Ingress protection rating: IP 67 or 68

Power cable gland thread size: M25

Data cable gland thread size: M16

Minimum entry thread length: 10 mm (0.4 in.)

Disassembly for access during installation

Before it can be installed, the Cyclo IP65 must be partly disassembled for access to mounting points and electrical connections. To disassemble:

1. Refer to the “*Product overview*” on page 4. Undo the front cover retaining clips (F) and remove the front cover (A) from the luminaire as illustrated below.

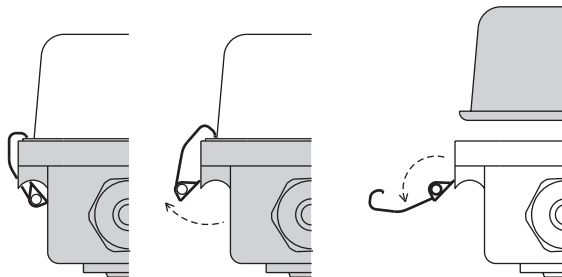

2. Remove one or more tubes (see “*Tube removal and replacement*” on page 32) to give access to the lamp module retaining screws (D) in the reflector tray.
3. Remove the two lamp module retaining screws to release the lamp module (C), and lift the lamp module clear of the housing (E). The lamp module is attached to the housing by retaining straps.

Mounting

The Cyclo IP65 features two mounting options:

- Surface mounting.
- Adjustable mounting using a 0-90° tiltable bracket, available as an accessory in two sizes to match the two sizes of housing available.

Surface mounting

The Cyclo IP65 can be surface-mounted on a floor, wall or ceiling.

To surface-mount the Cyclo IP65:

1. Ensure that the mounting surface is flat and can support the weight of all the devices to be installed on it. Allow 25 mm (1 inch) of free space around each luminaire.
2. Mark up two center points 840 mm (33.1 in.) apart and drill holes in the surface to take the mounting screws or bolts.
3. Fasten the luminaire to the surface by screwing two bolts or screws (grade 8.8 minimum) through the recesses in the luminaire housing. Pass the bolts or screws through the rubber sealing washers supplied with the luminaire before screwing them into the mounting surface. If using machine screws or bolts that are not self-tapping, drill guide holes in the housing that are slightly smaller in diameter than the screws, so that the screws are a tight fit in the housing. This will reduce the risk of water entering the luminaire around the screws.
4. Check that the luminaire housing is not distorted and is securely attached to the mounting surface before connecting cables (see following sections).

AC power

It is the installer's responsibility to ensure that all local safety regulations and legal requirements are observed when installing and connecting the Cyclo IP65.

AC mains power compatibility and consumption data are given in the Specifications section on page 38.

A switch on the circuit board can be moved to configure the Cyclo IP65 for 220 or 110 VAC power (see illustration: "*DIP-switch and power switch*" on page 16). The Cyclo IP65 is supplied factory-set for your local power. Check that the switch is correctly set, but you should not need to touch it.

RCDs and earth leakage

Many fixed installations use common neutral conductors in branch circuit distribution boxes. To avoid unintentional tripping of the RCD (residual current device/ground fault circuit breaker), ensure that the Cyclo IP65's neutral conductor is connected to AC power via the same RCD as the live conductor.

Important! Cyclo IP65s contain electronic ballasts that "leak" a total current of between 0.8mA and 4mA to ground (earth). Make sure that luminaires are correctly connected to ground (earthed) so that this "leakage" current can be absorbed.

Because of the "leakage" current, we recommend connecting a maximum of seven Cyclo IP65 luminaires per circuit where each circuit is protected by a 30mA RCD. This should avoid unintentional tripping of RCDs. Bear in mind that some RCDs rated at 30mA may trip when leakage to ground is as low as 20mA.

Depending on the type of installation, electrical regulations in some countries may permit the use of RCDs with a trip current rating higher than 30mA. When considering this option, the installer must ensure that all local building and electrical regulations are respected.

Connecting to power

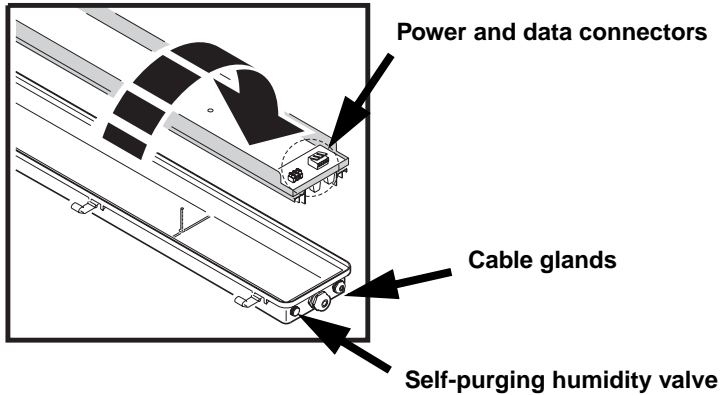

Power cable must be adequately dimensioned and of appropriate type for the installation. Ensure that power cannot be applied to the cable during installation.

The Cyclo IP65 is supplied with two cable glands that must be used for power cable entry and exit.

Two clamp connectors are provided, one in each end of the casing, for connecting to power. Luminaires are through-wired, so it is not important which of the two connectors is used for power input and which for power output.

Some common color-coding systems for AC mains wiring are given below:

Wire (EU)	Wire (US)	Pin	Marking
brown	black	live	“L” or “1”
blue	white	neutral	“N”
yellow/green	green	ground	\perp

To connect AC power cables:

1. If the front cover and lamp module have not been removed, remove them (see “*Disassembly for access during installation*” on page 8). Connection may be easiest with the lamp module hanging from its retaining straps.
2. Dismantle a power cable gland (the M25 power cable glands are larger than the M16 control cable glands). Depending on model, two types of

cable gland are supplied (see Figure 1 and Figure 2)

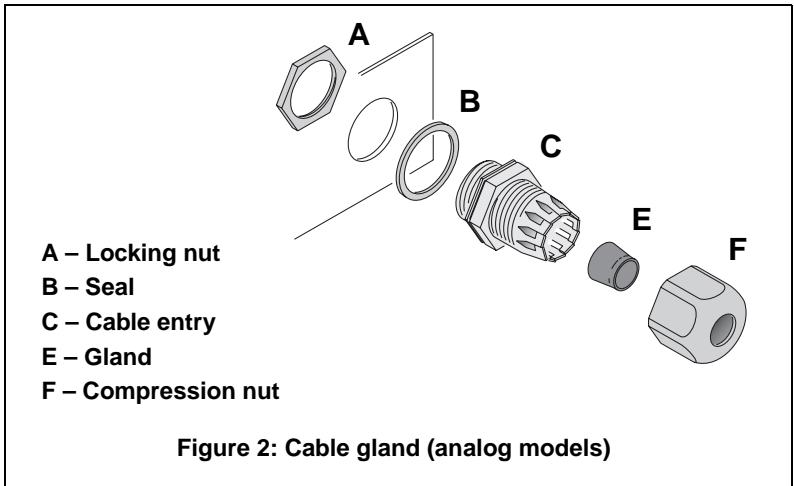
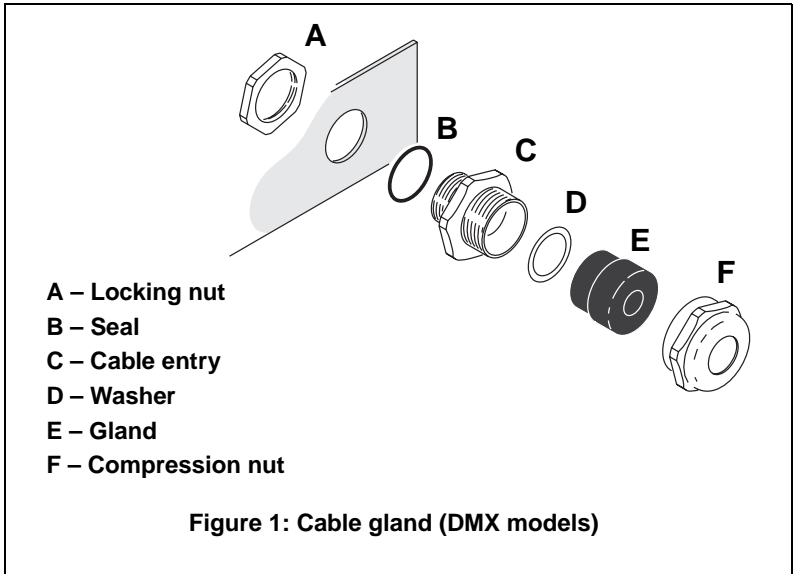

3. Ensure that there is a rubber seal **B** on the locking nut end of the cable gland **C**, and push this end through the hole provided in the luminaire housing so that the seal faces the outer surface of the housing.
4. Screw the locking nut **A** onto the cable entry from inside the housing. Prevent the cable entry from turning, and tighten the locking nut until the

seal makes a water-resistant seal against the outer surface of the housing. Do not over-tighten, as this may damage the seal or housing.

5. Thread the power input cable through the compression nut **F**, gland **E**, (then washer **D** on DMX models), and cable entry **C** into the luminaire housing.
6. Allow approx. 30 cm (12 in.) of cable slack inside the housing. Prevent the cable entry from turning and tighten the compression nut sufficiently to make a water-resistant seal. Do not over-tighten, as this may damage the gland. Check that the cable is firmly gripped in the rubber gland.
7. Connect the power cable wires to the connectors marked \perp , **L**, and **N**.
 - Connect the terminal marked \perp to ground (earth).
 - Connect the terminal marked **N** to neutral
 - Connect the terminal marked **L** to live..

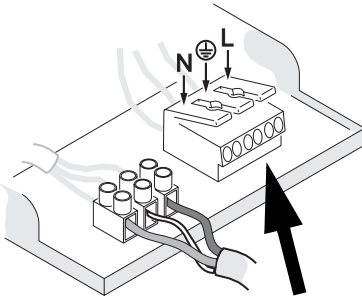

Figure 3: Power connection (DMX models)

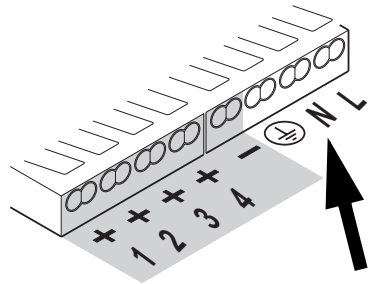

Figure 4: Power connection (analog models)

8. If power cable is to continue to another luminaire, repeat steps 2 to 7 for the power output cable.

For details of connecting digital control cables for DMX or master/slave operation, see “*Linking luminaires for DMX and master-slave operation*” on page 14.

For details of connecting analog control cables for analog dimmer operation, see “*Linking luminaires for analog dimmer operation*” on page 20.

For details of reassembling the luminaire after you have finished connecting cables, see “*Reassembly after installation*” on page 21.

Linking luminaires for DMX and master-slave operation

This section applies to DMX models only.

You need to create a serial data link to:

- Control luminaires with a DMX control device.
- Operate two or more Cyclo IP65s in master/slave stand-alone mode, where all luminaires run a synchronized light show without a separate DMX control device.

A reliable data connection requires suitable cable. CAT 5 (category 5) UTP (unshielded twisted pair) network cable is suitable for this purpose. The minimum recommended wire size is 0.2 mm² (24 AWG) for runs up to 300 meters (1000 ft.) and 0.322 mm² (22 AWG) for runs up to 500 meters (1640 ft.). Your Martin Architectural dealer can advise and supply suitable cable.

Luminaires on a serial data link must be daisy-chained in one single line, maximum 500 meters (1640 ft.) long, with maximum 32 luminaires. To exceed 32 luminaires or 500 meters, or to add branches, an optically isolated amplifier-splitter such as the Martin RS-485 Opto-Splitter (P/N 90758060) must be used.

A male 3-pin XLR connector can be fitted at the controller end of the data link to allow a standard connection to Martin DMX controller. The XLR connector should be wired as follows:

- Pin 1: shield
- Pin 2: DMX - (cold)
- Pin 3: DMX + (hot)

To avoid ground/earth loop interference, make sure the DMX cable shield does not come into contact with the shell or body of the XLR connector.

Two screw-type terminal blocks are provided, one in each end of the casing, for connecting to data. Luminaires are through-wired, so it is not important which of the two terminal blocks is used for data input and which for data output. However, the data output may only be used to relay data to one luminaire.

Connecting to control data

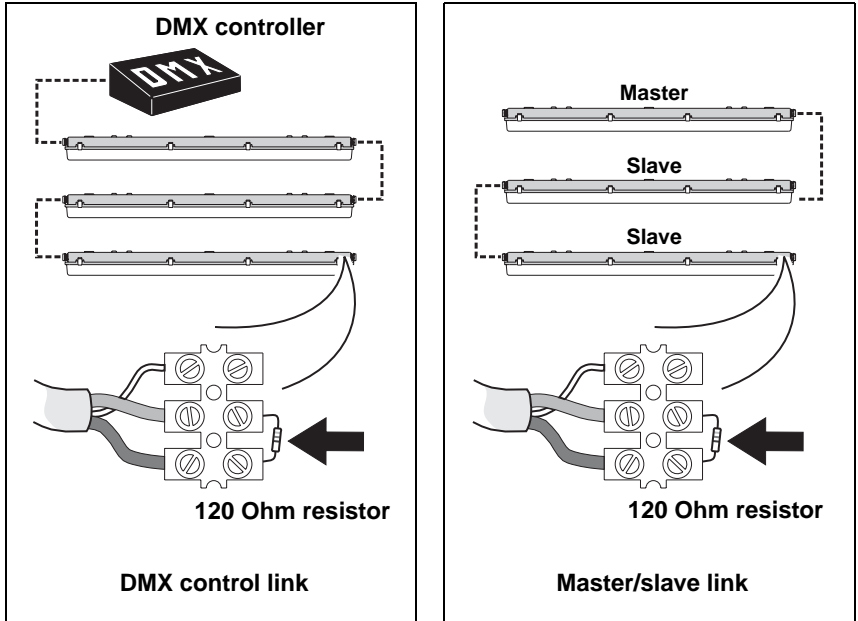

To create the data link:

1. If using a DMX control device, run suitable cable from the controller's DMX output to the first luminaire on the link.
2. Use an M16 cable gland to run the data cable through the luminaire housing (for instructions on installing cable glands, see "Connecting to power" on page 11).
3. Connect the data cable wires to whichever of the two terminal blocks is most convenient. Wiring polarity is labelled on the luminaire.
4. Continue connecting up to 32 luminaires using the above procedure.
5. Terminate the data link by connecting a 120 Ohm, 0.25 W resistor across the + (hot) and - (cold) terminals of the last luminaire's terminal block.

Tip!

Random "flicker" and other unexplained control problems during stand-alone master/slave operation can often be cured by also connecting a 120 Ohm resistor across the + (hot) and - (cold) terminals of the first luminaire's data connection terminal block.

Configuring luminaires for DMX or stand-alone operation

Each DMX model Cyclo IP65 luminaire needs to be set up for DMX or stand-alone operation using the DIP switch located on the circuit board on the lamp module.

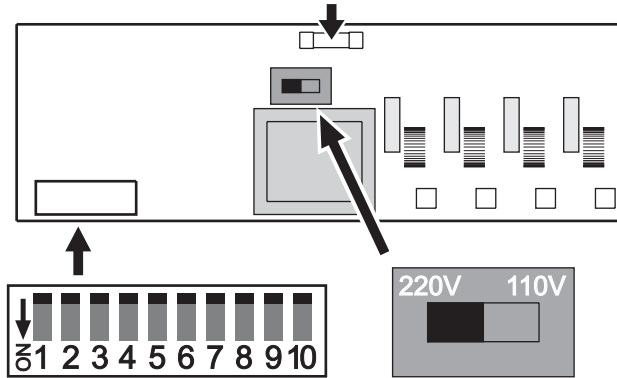

DIP-switch and power switch

Configuring for DMX operation

DMX operation is enabled by setting pin 10 on the DIP switch to OFF. Pins 1 - 9 are then used to set the luminaire's control address.

The Cyclo IP65 uses one DMX channel to control each tube. The DMX address, also known as the start channel, is the first of these channels. It must be set on the luminaire (and selected on the DMX controller) before the controller can send commands to the luminaire via a data link. For example, a 03 model with its DMX address set to 101 uses channels 101, 102 and 103 to control its three tubes.

Allow enough channels when setting the DMX address. If control channels for two fixtures overlap, one of the fixtures will receive the wrong commands.

If two or more Cyclo IP65s share the same DMX address, they will receive the same commands and respond identically. Individual control will be impossible.

The default factory-set control address is '1'.

To set the Cyclo IP65's DMX address:

1. Set DIP switch pin 10 to OFF.

- Decide on a DMX address for the luminaire. If you are calculating the DMX addresses for multiple luminaires, save time by using the online Martin Address Calculator at <http://www.martin.dk/service/utilities/AddrCalc/index.asp> (see illustration below).

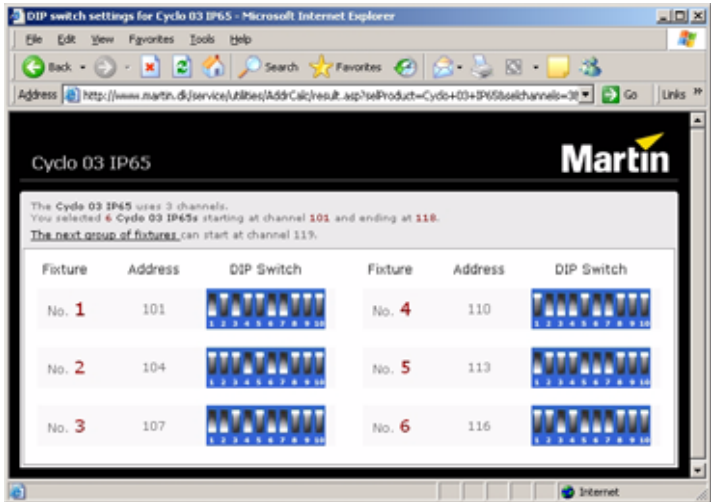

- You can also look up DIP switch settings using the Martin DIP Switch Calculator, available for use and downloadable at <http://www.martin.dk/service/dipswitchpopup.htm>. If you do not have Internet access, refer to "Table 1: DMX address DIP switch settings" on page 18.

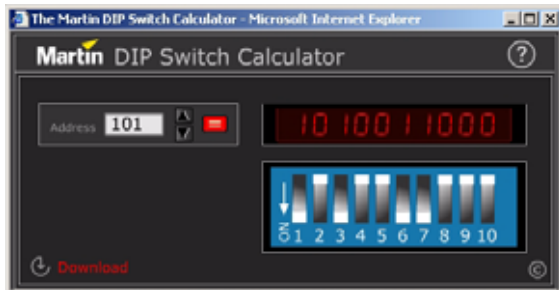

- Set DIP switch pins 1 through 9 to ON (1) or OFF (0) with reference to the table.

Configuring for stand-alone operation

Stand-alone operation is enabled by setting pin 10 on the DIP switch to ON and pin 8 to OFF. The other pins are then used to program the luminaire. See “*Operation in extreme ambient temperatures*” on page 23 for details of how to set these pins.

Linking luminaires for analog dimmer operation

This section applies to analog dimmer models only.

You need to create an analog dimmer control link to control the Intensity of the Cyclo IP65's tubes via a dimmer that uses variable tension from 0-10 V to control each tube.

Connecting the dimmer control cable

Two clamp connectors are provided, one in each end of the casing, for connecting to an analog dimmer. Luminaires are through-wired, so it is not important which of the two connectors is used for dimmer control input and which for output.

The number of terminals on each clamp connector varies depending on model.

To connect a dimmer:

1. Run suitable cable from the analog controller's output to the first luminaire on the link.
2. Use an M16 cable gland to run the dimmer control cable through the luminaire housing (for instructions on installing cable glands, see "*Connecting to power*" on page 11).
3. Tube numbers and polarity are labelled. Connect the ground (earth) wire to the - terminal and the tube control wires to the + numbered terminals.
4. Use the clamp connector at the other end of the luminaire for output to the next luminaire, and continue connecting other luminaires using the above procedure. Your dimmer's user manual should specify how many luminaires your dimmer can control.

If you apply power to a Cyclo IP65 that is not connected to a dimmer, all tubes will operate at full power.

Dimmer control using a 516-II DMX to 0-10 V converter

The Martin 516-II DMX to 0-10 V Converter can be used to control analog Cyclo IP65 luminaires with a DMX controller. This converter has 16 analog

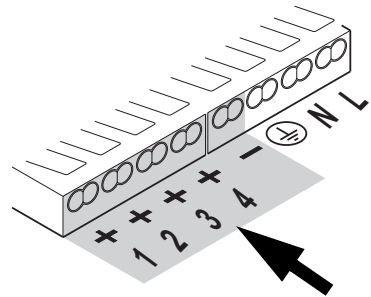

Figure 5: Analog control connection (04 model illustrated)

outputs for connecting 0-10 V analog devices. For independent control, a 02 model requires two of these outputs (one per ballast), a 03 requires three outputs, and a 04 requires four outputs.

You can simultaneously control dimming on multiple Cyclo luminaires with the same number of tubes if you link them via their analog control connectors. However, a maximum of 10 Cyclos of the same model can be wired to the same analog output/s on the 516-II DMX to 0-10 V Converter. Each Cyclo in the series will mimic the behavior of the others.

This means that a single 516-II DMX to 0-10 V Converter can provide independent control of up to 8 groups of 10 Cyclo 02s (80 luminaires), 5 groups of 10 Cyclo 03s (50 luminaires), 4 groups of 10 Cyclo 04s (40 luminaires), or a combination of groups of up to 10 of each model.

If you are connecting multiple Cyclo luminaires in series, the length and diameter of the control (dimmer) cabling must be dimensioned so that the voltage drop over the cabling is less than 0.5 volts.

Do not wire different Cyclo models in series to the same analog outputs.

Wiring the 5-pin DIN connector

Use a 5-pin DIN connector to connect the 516-II converter to a series of one or more Cyclos of the same type. The converter has four 5-pin DIN outputs enabling control of up to four parallel series of Cyclo luminaires.

The pin configuration is labelled on the rear panel of the Converter. Always connect the ground wire to pin 2, and control wires to the other pins (between 2 and 4 depending on the number of tubes in the Cyclo that is being connected). Make a note of which wires are connected to which channels, as well as which wire is the ground (earth) wire.

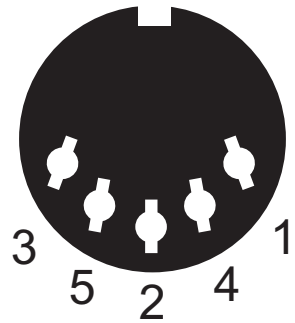

Note: connections can be tested without a controller by setting all pins on the 516-II Converter's DIP-switch to the OFF position and then applying power to the converter and the luminaires.

Reassembly after installation

The rest of this section applies to all models.

To reassemble the luminaire after installing and configuring:

1. Seal any holes that have not been used for cable entry with the blanking plugs and flat rubber seals supplied with the luminaire. These should be tight enough to make a waterproof seal, but do not over-tighten.
2. Reinstall the lamp module in the housing, making sure that no wires are trapped.
3. Reinstall any tubes that were removed. On 03 and 04 models, colored tube positions are labelled R, G and B. On 02 models, the positions of the two white tubes are labelled 827 for warm white and 860 for daylight white. Note that tubes should be installed with their manufacturers' markings at the same end of the luminaire.
4. Reinstall the front cover before applying power.

Burning in fluorescent tubes

Optimum tube performance is obtained after burning in new fluorescent tubes by running them for 100 hours at full power.

Avoiding condensation and humidity

Excess humidity inside the luminaire can be experienced if:

- The front cover is not correctly clipped onto its seal.
- Cable glands are not correctly assembled, tightened and matched to cable diameters
- Blanking plugs are not correctly fitted and tightened
- Cables open into damp or wet locations (e.g. poorly sealed junction boxes), which will encourage moisture to pass along the cable into the luminaire.

The Cyclo IP65 is fitted with a self-purging valve that gradually expels moisture as the luminaire heats up and cools down in normal use. To eliminate condensation rapidly (after installation, for example), run the luminaire at full operating temperature in dry weather conditions for a minute or two with the front cover removed so that air circulates, then refit the front cover while the luminaire is hot. If you do this:

- The exposed lamp and internals present a risk:, so block public access.
- Ensure that no dust or objects enter the luminaire while it is open.

Operation in extreme ambient temperatures

Do not operate the Cyclo IP65 if the ambient temperature exceeds 40° C.

Cyclo IP65 luminaires can be operated in ambient temperatures as low as -20° C (-4° F), but a combination of low temperature and low dimming level will give a risk of flickering and cause voltage across tubes to rise. In extreme cases, luminaires will shut down power to tubes to avoid damage to components. If this happens, luminaires must be reset by powering them off and on again before tubes can be restarted.

Flickering can be avoided at ambient temperatures below freezing point if luminaires are operated so that they generate their own heat and maintain tube temperature at or above freezing point. For best low-temperature dimming performance:

- As soon as the ambient temperature falls below 0° C (32° F), apply power permanently to luminaires. If light output is not required, reduce output by dimming tubes instead of shutting down power completely.
- If flickering occurs when dimming, increase the minimum dimming level.
- If flickering occurs when dimming luminaires after startup, start luminaires at full power for several minutes.

As a general rule, the higher the light output, the lower the ambient temperature luminaires can tolerate.

Stand-alone operation

Stand-alone operation is available in DMX models only.

In stand-alone operation, Cyclo IP65 DMX models can run light shows without a DMX controller. Luminaires can be programmed to change colors in cycles. Changes can be programmed at 1, 5, 10 or 30 second intervals.

Two stand-alone operation modes are available:

- In **single stand-alone operation**, luminaires run independently of each other. No data link is required.
- In **master/slave stand-alone operation**, luminaires must be linked with a serial data link (“*Linking luminaires for DMX and master-slave operation*” on page 14 explains how to install this link). Synchronized action in all luminaires is triggered by one “master” luminaire.

In both single and master/slave stand-alone operation, luminaires are programmed by setting the pins on the DIP switch on the circuit board as shown in the following tables.

Pin	Function		
1	Cool white active		
2	Red active		
3	Green active		
4	Blue active		
5 & 6	Program speed		
	Pin 6	Pin 5	Speed
	OFF	OFF	1 sec. steps (fastest setting)
	OFF	ON	5 sec. steps
	ON	OFF	10 sec. steps
	ON	ON	30 sec. steps (slowest setting)
7	OFF = Blackout fading, ON = Crossfading		
8	OFF = Run program, ON = Deactivate program (Note: always set to OFF)		
9	OFF = Master, ON = Slave (Note: do not set more than one luminaire as master)		
10	ON = Stand-alone mode.		

Table 2. Stand-alone DIP switch settings – 04 DMX models

Pin	Function															
1	Red active															
2	Green active															
3	Blue active															
4	Not used															
5 & 6	Program speed															
	<table border="1"> <thead> <tr> <th>Pin 6</th> <th>Pin 5</th> <th>Speed</th> </tr> </thead> <tbody> <tr> <td>OFF</td> <td>OFF</td> <td>1 sec. steps (fastest setting)</td> </tr> <tr> <td>OFF</td> <td>ON</td> <td>5 sec. steps</td> </tr> <tr> <td>ON</td> <td>OFF</td> <td>10 sec. steps</td> </tr> <tr> <td>ON</td> <td>ON</td> <td>30 sec. steps (slowest setting)</td> </tr> </tbody> </table>	Pin 6	Pin 5	Speed	OFF	OFF	1 sec. steps (fastest setting)	OFF	ON	5 sec. steps	ON	OFF	10 sec. steps	ON	ON	30 sec. steps (slowest setting)
Pin 6	Pin 5	Speed														
OFF	OFF	1 sec. steps (fastest setting)														
OFF	ON	5 sec. steps														
ON	OFF	10 sec. steps														
ON	ON	30 sec. steps (slowest setting)														
7	OFF = Blackout fading, ON = Crossfading															
8	OFF = Run program, ON = Deactivate program (Note: always set to OFF)															
9	OFF = Master, ON = Slave (Note: do not set more than one luminaire as master)															
10	ON = Stand-alone mode.															

Table 3. Stand-alone DIP switch settings – 03 DMX models

Pin	Function															
1	Daylight white (6000 K) active															
2	Warm white (2700 K) active															
3	Not used															
4	Not used															
5 & 6	Program speed															
	<table border="1"> <thead> <tr> <th>Pin 6</th> <th>Pin 5</th> <th>Speed</th> </tr> </thead> <tbody> <tr> <td>OFF</td> <td>OFF</td> <td>1 sec. steps (fastest setting)</td> </tr> <tr> <td>OFF</td> <td>ON</td> <td>5 sec. steps</td> </tr> <tr> <td>ON</td> <td>OFF</td> <td>10 sec. steps</td> </tr> <tr> <td>ON</td> <td>ON</td> <td>30 sec. steps (slowest setting)</td> </tr> </tbody> </table>	Pin 6	Pin 5	Speed	OFF	OFF	1 sec. steps (fastest setting)	OFF	ON	5 sec. steps	ON	OFF	10 sec. steps	ON	ON	30 sec. steps (slowest setting)
Pin 6	Pin 5	Speed														
OFF	OFF	1 sec. steps (fastest setting)														
OFF	ON	5 sec. steps														
ON	OFF	10 sec. steps														
ON	ON	30 sec. steps (slowest setting)														
7	OFF = Blackout fading, ON = Crossfading															
8	OFF = Run program, ON = Deactivate program (Note: always set to OFF)															
9	OFF = Master, ON = Slave (Note: do not set more than one luminaire as master)															
10	ON = Stand-alone mode.															

Table 4. Stand-alone DIP switch settings – 02 DMX models

A quick reference table covering DIP switch functions is also provided on the back cover of this manual.

Stand-alone operation settings

Activating colors

DIP switch pins 1 to 4 activate tubes in the stand-alone program.

Setting program speed

Combinations of DIP switch pins 5 and 6 allow one of four different speeds to be set.

Fading between colors

If DIP switch pin 7 is set to OFF (blackout fading), colors fade to almost blackout before the next color fades in.

If DIP switch pin 7 is set to ON (crossfading), color fading overlaps. If two or more colors are active, one color fades in while another is fading out, giving a color mixing effect. For example, if red and blue are activated and crossfading is selected, colors will crossfade from red through purple to blue, then back through purple to red in a continuous cycle (see example).

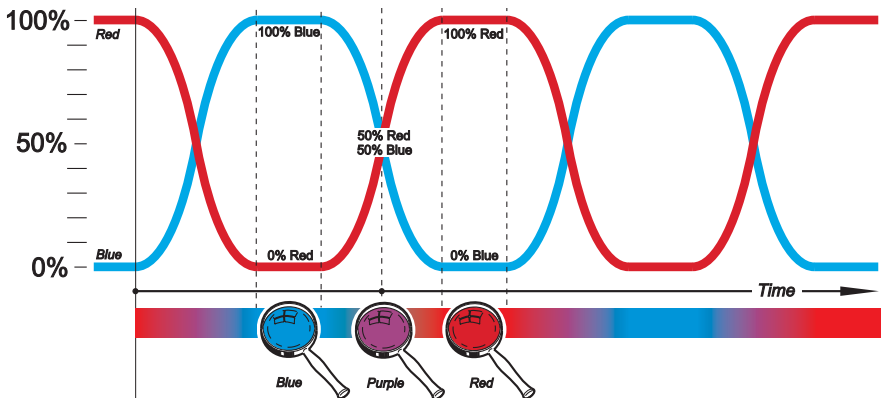

Example: crossfading between red and blue

Single stand-alone operation

In single stand-alone operation, a luminaire runs its own program independently of all other luminaires. To do this, the luminaire must be set as a master.

Activating single stand-alone operation

To activate single stand-alone operation:

1. Set DIP switch pin 10 to ON (switches from DMX to stand-alone mode).
2. Set DIP switch pin 9 to OFF (activates master mode).
3. Set DIP switch pin 8 to OFF (activates stand-alone mode)
4. Program the luminaire using DIP switch pins 1 - 7 (see tables on pages 24 and 25).

Master/slave stand-alone operation

Important! Do not set more than one luminaire on a data link as master, and do not set a luminaire as master on a data link with a DMX controller. Doing so may cause damage to the electronics that is not covered by the product warranty.

In master/slave stand-alone operation, one master luminaire transmits a synchronizing signal to slave luminaires over the data link each time it starts a new action. Slave luminaires start their next programmed action when they receive this signal from the master luminaire. Programs can be identical on all luminaires, or luminaires can – subject to certain practical constraints – run programs that are synchronized but not identical.

Note that each luminaire follows the program set on its own DIP switch as described in the tables on pages 24 and 25.

Note also that colors are always displayed in the following order:

- On 04 models, white → red → green → blue.
- On 03 models, red → green → blue
- On 02 models, daylight white → warm white

This means for example that if red is activated, it will always be first in the program. If red is not activated but green is activated, green will be first in the program.

More sophisticated light shows can be programmed using a DMX controller (see “*DMX-controlled operation*” on page 31).

The synchronization signal used by the Cyclo IP65 is identical to that used in other Cyclo luminaires with the same number of tubes, allowing these products to be combined in master/slave operation on one data link. However, Cyclos with different numbers of tubes cannot be mixed in master-slave operation. Consult your Martin Architectural dealer if you need advice on combining and controlling products.

Identical light shows

Master and slave luminaires can be set to behave identically. In this mode, the master sends synchronizing signals to the slaves, and all luminaires run the same light show. Each slave luminaire follows the program set on its own DIP switch, so for identical operation, all luminaires' DIP switch settings must be the same apart from pin 9, which is set to ON for slaves and OFF for the master.

Synchronized non-identical light shows

It is also possible to synchronize changes but program slave luminaires to behave differently from the master. To use this feature effectively, you need to plan your light show using *scenes* as building blocks and set the luminaires' DIP switches accordingly.

A scene is a change from one output to another. When a luminaire is in slave mode, it starts a scene when it receives a synchronization signal from the master. The time taken by the scene is determined by the speed setting of the DIP switch. A slave will not respond to new synchronization signals until its scene is complete.

When crossfading is selected, each color takes up one scene (fade in only). When blackout fading is selected, each color takes up two scenes (fade in and fade out). This means that the maximum number of scenes that can be programmed is twice the number of tubes installed, with all tubes activated and blackout fading selected.

Each time the master luminaire starts at scene 1, it sends a signal to all the slave luminaires to start at scene 1. This means that if a slave luminaire has:

1. Fewer scenes than the master luminaire, it will run these in a cycle until the master luminaire signals that the program should start from the beginning again.
2. More scenes than the master, the additional scenes will never run, because the program will reset to the first scene when the master starts its program from the beginning.





Here is an example of what will happen when a slave luminaire has fewer scenes than the master luminaire:

Luminaire setting	Scene pattern
Master with 6 scenes	1 2 3 4 5 6 1 2 3 4 5 6 ...
Slave with 4 scenes	1 2 3 4 1 2 1 2 3 4 1 2 ...

Program examples













The following examples of programs on 03 and 04 models show how an individual luminaire's program is made up of scenes. The same principle can be applied to 02 models, if desired.

The following symbols are used in program diagrams:

	Tube turned fully off
	Fade in
	Fade out
	Fade to 50% and back to 100% in one scene (applies when only one color is active and crossfading is selected)

Example 1

DIP switch 7 is set to ON (crossfading) and only red is activated:

Red												
Scene	1	1	1	1	1	1	1	1	1	1	1	1

Example 2

DIP switch 7 is set to OFF (blackout fading) and only red is activated:

Red												
Scene	1	2	1	2	1	2	1	2	1	2	1	2

Example 3

DIP switch 7 is set to ON (crossfading) and red and blue are activated:

Red	/	\	/	\	/	\	/	\	/	\	/	\
Blue	\	/	\	/	\	/	\	/	\	/	\	/
Scene	1	2	1	2	1	2	1	2	1	2	1	2

Example 4

DIP switch 7 is set to OFF (blackout fading) and red and blue are activated:

Red	/	\	-	-	/	\	-	-	/	\	-	-
Blue	-	-	/	\	-	-	/	\	-	-	/	\
Scene	1	2	3	4	1	2	3	4	1	2	3	4

Example 5

To achieve a rainbow effect on 03 and 04 models, activate red, green and blue tubes and set DIP switch pin 7 to ON (crossfading).

Red	/	\	-	/	\	-	/	\	-	/	\	-
Green	-	/	\	-	/	\	-	/	\	-	/	\
Blue	\	-	/	\	-	/	\	-	/	\	-	/
Scene	1	2	3	1	2	3	1	2	3	1	2	3

Activating master/slave stand-alone operation

To activate master/slave stand-alone operation:

1. Isolate all luminaires from power.
2. Set all luminaires as slaves and enable stand-alone mode by setting DIP switch pins 9 and 10 to ON and pin 8 to OFF.
3. Decide which luminaire to use as master and set this luminaire's DIP switch pin 9 to OFF. Note that any luminaire can be set as master, but you will obtain the most reliable data signal by either setting the first luminaire on the link as master or using 120 Ohm resistors to terminate the data link (see "Connecting to control data" on page 15) at both ends.
4. When power is applied, slave luminaires will go to the next scene in their program each time the master goes to its next scene. Slave luminaires will also start scene 1 of their programs each time the master starts scene 1 of its program.

DMX-controlled operation

Cyclo IP65 DMX models may be operated with any lighting control device that is compatible with the USITT DMX (1990) standard.

For details of connecting luminaires on a data link to a DMX controller, see “*Linking luminaires for DMX and master-slave operation*” on page 14.

For details of setting up luminaires for DMX control, see “*Configuring luminaires for DMX or stand-alone operation*” on page 16

DMX control functions

The Cyclo IP65's advanced fluorescent tubes can be dimmed from maximum output right down to zero using one channel per tube on a DMX controller. This allows a wide range of color shades with variable intensity to be obtained using additive color mixing. The color temperature of white light can also be fine-tuned.

Depending on the functions available on the controller, sophisticated light shows on the Cyclo IP65 can be programmed over time, allowing constantly and rapidly shifting color mixes, or color displays which change slowly according to the time of day, or even year, for example. See the controller's manual for details.

Your Martin Architectural dealer can advise about available controllers and control options.

Service

With long-life fluorescent tubes and no moving parts, the Cyclo IP65 is almost service-free.

Tube removal and replacement

The Osram high output T5 tubes fitted as standard meet color specifications for at least 10 000 hours. Average tube life is 20 000 hours, but note that tube life will vary depending on operating conditions.

No tools are required to replace a fluorescent tube on the Cyclo IP65.

To remove tubes:

1. Isolate the luminaire from power and ensure that power cannot be reapplied, even accidentally.
2. Ensure that the luminaire is securely mounted and block access below the work area before beginning any servicing work.
3. Remove the front cover retaining clips and remove the cover.

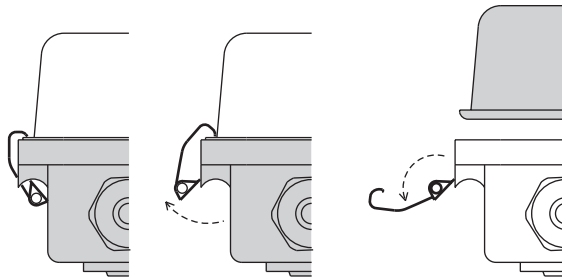

Front cover removal

4. Holding the metal caps at both ends of the tube, rotate the tube 1/4 turn in whichever direction is easiest, and slide the tube's terminal pins out of their sockets. Support the tube at both ends as it is released.

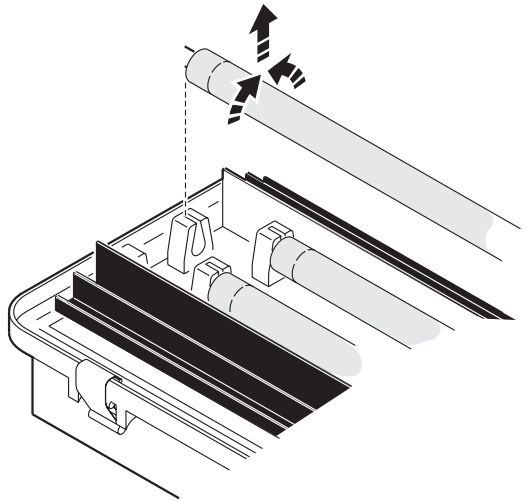

Tube removal (04 model illustrated)

5. To install a new tube, line it up so that the manufacturer's markings on all tubes are at the same end of the luminaire. Slide the tube's terminal pins fully into their sockets and rotate the tube 1/4 turn in any direction to engage the pins. Check that the tube is held securely in the sockets.
6. Reinstall the front cover before reapplying power.

Tube positions

Tube positions on Cyclo IP65 03 and 04 models are labelled **R** for red, **G** for green and **B** for blue.

On 04 models, white tubes are fitted in the position that is not labelled.

On 02 models, positions of the warm 827 (2700 K) and daylight 860 (6000 K) tubes are labelled.

The burning positions of fluorescent tubes affect their warm-up times, operating temperature, light output and tube life. For optimum results:

- Install tubes so that the manufacturer's markings are all at the same end of the luminaire.
- If the luminaire is installed in a vertical position or at an angle from the horizontal, locate the ends of the tubes that carry the manufacturer's markings at the lower end of the luminaire (in a cold environment, i.e. where temperatures are generally around or below freezing point, locate the markings at the *upper* end of the luminaire).

Main fuse replacement

The main fuse is located on the circuit board. See page 38 in the Specifications section for details of fuse types and ratings. Never replace a fuse with one of a different type or rating.

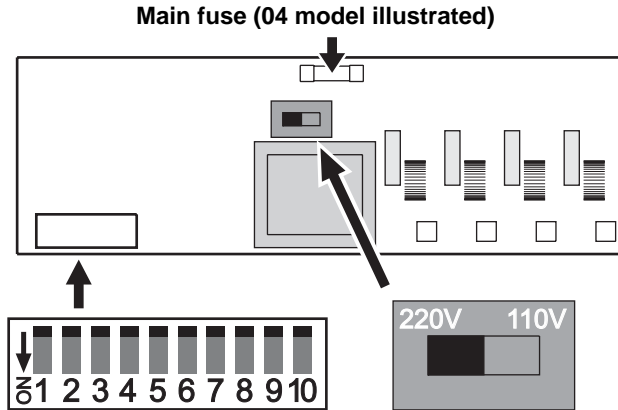

Always isolate luminaires from power and ensure that power cannot be reapplied accidentally before replacing fuses.

If a fuse blows repeatedly, refer to your Martin Architectural dealer for service.

Cleaning

Use a damp cloth to wipe luminaires clean.

Do not use a high pressure water-jet for cleaning: IP65 luminaires are protected against splashing and low-pressure water jets only.

Troubleshooting

Problem	Probable cause(s)	Remedy
No response from luminaire when power is applied.	If running in stand-alone mode, DIP switch pin 8 is set to ON.	Set DIP switch pin 8 to OFF to allow stand-alone operation.
	No power to luminaire.	Check power connections.
	Ground fault protection circuit breaker (RCD) has tripped.	Reset RCD. If problem persists, have an electrician replace the RCD or reduce the number of luminaires powered via one RCD.
Luminaires do not respond correctly to DMX control.	Controller not connected.	Check DMX data link. Inspect connections and test cables. Repair or replace as necessary.
	Incorrect DMX addressing.	Check address setting on luminaire and controller.
	Data link not terminated.	Connect 120 Ohm termination resistor across data link + (hot) and - (cold) in parallel with last luminaire on link.
	Two devices transmitting on link.	Check that all luminaires are set as slaves (DIP switch pin 9 ON).
	Defective luminaire.	Bypass luminaires one at a time until normal operation is regained.
Luminaires do not respond correctly to dimmer control.	Faulty connections to dimmer.	Check cables and connections and rectify.
	Defective luminaire.	Bypass luminaires one at a time until normal operation is regained.
Luminaires do not behave correctly in master/slave mode	Two luminaires transmitting on link.	Check that only one luminaire is set to operate as master.
	Defective luminaire.	Bypass luminaires one at a time until normal operation is regained.
Poor quality light output and/or color rendering.	Tube or tubes not burnt in.	Run luminaire for at least 100 hours to burn in tubes.
	Tube defective.	Disconnect luminaire and replace tube.

DMX protocols

Start code = 0

Channel	Value	Percent	Function
1	0-2	0	Cool white intensity Tube off
	3-252	1 - 99	Intensity 1→100%
	253-255	100	Intensity 100%
2	0-2	0	Red intensity Tube off
	3-252	1 - 99	Intensity 1→100%
	253-255	100	Intensity 100%
3	0-2	0	Green intensity Tube off
	3-252	1 - 99	Intensity 1→100%
	253-255	100	Intensity 100%
4	0-2	0	Blue intensity Tube off
	3-252	1 - 99	Intensity 1→100%
	253-255	100	Intensity 100%

Table 5: DMX protocol, Cyclo IP65 04 models

Start code = 0

Channel	Value	Percent	Function
1	0-2	0	Red intensity
	3-252	1 - 99	Tube off
	253-255	100	Intensity 1→100% Intensity 100%
2	0-2	0	Green intensity
	3-252	1 - 99	Tube off
	253-255	100	Intensity 1→100% Intensity 100%
3	0-2	0	Blue intensity
	3-252	1 - 99	Tube off
	253-255	100	Intensity 1→100% Intensity 100%

Table 6: DMX protocol, Cyclo IP65 03 models

Start code = 0

Channel	Value	Percent	Function
1	0-2	0	Daylight white (6000 K) intensity
	3-252	1 - 99	Tube off
	253-255	100	Intensity 1→100% Intensity 100%
2	0-2	0	Warm white (2700 K) intensity
	3-252	1 - 99	Tube off
	253-255	100	Intensity 1→100% Intensity 100%

Table 7: DMX protocol, Cyclo IP65 02 models

Cyclo IP65 Specifications

Specifications subject to change

Physical

28 watt tube models

Cyclo IP65 02 analog, 28W tubes

L x W x H 1276 x 100 x 106 mm (50.3 x 3.9 x 4.2 in.)

Weight 3.8 kg (8.4 lbs)

Cyclo IP65 02 DMX, 28W tubes

L x W x H 1276 x 100 x 106 mm (50.3 x 3.9 x 4.2 in.)

Weight 4.4 kg (9.7 lbs)

Cyclo IP65 03 analog, 28W tubes

L x W x H 1276 x 100 x 106 mm (50.3 x 3.9 x 4.2 in.)

Weight 4.3 kg (9.4 lbs)

Cyclo IP65 03 DMX, 28W tubes

L x W x H 1276 x 100 x 106 mm (50.3 x 3.9 x 4.2 in.)

Weight 5.0 kg (11.0 lbs)

Cyclo IP65 04 analog, 28W tubes

L x W x H 1276 x 169 x 106 mm (50.3 x 6.7 x 4.2 in.)

Weight 5.8 kg (12.8 lbs)

Cyclo IP65 04 DMX, 28W tubes

L x W x H 1276 x 169 x 106 mm (50.3 x 6.7 x 4.2 in.)

Weight 7.2 kg (15.8 lbs)

54 watt tube models

Cyclo IP65 03 analog, 54W tubes

L x W x H 1276 x 169 x 106 mm (50.3 x 6.7 x 4.2 in.)

Weight 6.4 kg (14.1 lbs)

Cyclo IP65 03 DMX, 54W tubes

L x W x H 1276 x 169 x 106 mm (50.3 x 6.7 x 4.2 in.)

Weight 6.7 kg (14.8 lbs)

Source

Approved light source: Osram T5 28W or 54W fluorescent tubes,
according to model

Color authenticity Guaranteed to 10 000 hours

Average tube life 20 000 hours

Dynamic effects

Cyclo IP65 04

0-100% dimmable tubes. Daylight white (4000 K), red, green & blue

Cyclo IP65 03

0-100% dimmable tubes. Red, green & blue

Cyclo IP65 02

Color temperature control. 2700 - 6000 K

Control and programming

DMX models

Control method. USITT DMX 512 (1990)

Receiver RS-485

Setting and addressing. DIP switch

Data input/ output. Through-wired, cable in/out via IP68 cable gland

Number of DMX channels 4 (Cyclo IP65 04 DMX)

3 (Cyclo IP65 03 DMX)

2 (Cyclo IP65 02 DMX)

Stand-alone dynamic capability single and master/slave operation,
programmed via DIP switch

Analog models

Control method. Analog dimmer, 0-10 V positive, shared negative

Data input/ output. Through-wired, cable in/out via IP68 cable gland

Number of dimmer channels 4 (Cyclo IP65 04 analog)

3 (Cyclo IP65 03 analog)

2 (Cyclo IP65 02 analog)

If using Martin 516-II DMX to 0-10 V Converter:

Number of independently controllable dimming channels. 16

Channels required per independently controlled Cyclo 02 group 2

Channels required per independently controlled Cyclo 03 group 3

Channels required per independently controlled Cyclo 04 group 4

Number of Cyclos per group (wired in series) . . . 1-10 (of same model)

Installation

Orientation Any

Minimum free space around luminaire 25 mm (1 inch)

Mounting options

Surface mounting

Wire suspension

90° tilt mounting bracket (available as accessory: see "Accessories" on
page 42)

Power

AC power (EU configuration) 200 - 250 V, 50 / 60 Hz
Main fuse (EU configuration) 1 AT, P/N 05020007
AC input Hard wired, cable entry via IP68 cable glands

Typical current and power

28 watt tube models

Cyclo IP65 02 analog, 28W tubes

Typical power and current @ 230 V, 50 Hz 0.28 A, 64 W

Cyclo IP65 02 DMX, 28W tubes

Typical power and current @ 230 V, 50 Hz 0.29 A, 65 W

Cyclo IP65 03 analog, 28W tubes

Typical power and current @ 230 V, 50 Hz 0.44 A, 98 W

Cyclo IP65 03 DMX, 28W tubes

Typical power and current @ 230 V, 50 Hz 0.45 A, 99W

Cyclo IP65 04 analog, 28 W tubes

Typical power and current @ 230 V, 50 Hz 0.52 A, 117 W

Cyclo IP65 04 DMX, 28W tubes

Typical power and current @ 230 V, 50 Hz 0.56 A, 128 W

54 watt tube models

Cyclo IP65 03 analog, 54W tubes

Typical power and current @ 230 V, 50 Hz 0.78 A, 179 W

Cyclo IP65 03 DMX, 54W tubes

Typical power and current @ 230 V, 50 Hz 0.80 A, 181 W

Allow for a deviation of +/- 10% from typical figures listed above.

Measurements made at nominal voltage. Local supply voltages can vary by +/- 10%.

Thermal

Maximum ambient temperature (T_a) 40° C (104° F)

Minimum ambient temperature when permanently powered
(starting from and dimming at 1% output possible) -20°C (-4°F)

Cooling Convection

Construction

Housing Polyester-reinforced composite

Front cover Unbreakable polycarbonate

Front cover clips Stainless steel

Protection factor IP65

Finish Cream

Approvals



European safety: EN 60598-1, EN 60598-2
EMC: EN 60555-3. EN 55015

Included items

User manual P/N 35000170
2 x rubber sealing washers for mounting screws

Osram T5 fluorescent tubes (installed) according to model:

Cyclo 02 28W models

Warm white (col. temp. 2700 K) T5 tube OSRAM T5 FH 28W/827
Daylight white (col. temp. 6000 K) T5 tube OSRAM T5 FH 28W/860

Cyclo 03 28W models

Red T5 tube OSRAM T5 FH 28W/60
Green T5 tube OSRAM T5 FH 28W/66
Blue T5 tube OSRAM T5 FH 28W/67

Cyclo 04 28W models

Cool white (col. temp. 4000 K) T5 tube OSRAM T5 FH 28W/840
Red T5 tube OSRAM T5 FH 28W/60
Green T5 tube OSRAM T5 FH 28W/66
Blue T5 tube OSRAM T5 FH 28W/67

Cyclo 03 54W models

Red T5 tube OSRAM T5 FQ 54W/60
Green T5 tube OSRAM T5 FQ 54W/66
Blue T5 tube OSRAM T5 FQ 54W/67

Cable fittings: DMX models

2 x M25 cable glands, IP68, metal, cable Ø 7-14 mm
2 x M16 cable glands, IP68, metal, cable Ø 3.5 - 10 mm
1 x M25 blanking plug, metal
1 x M16 blanking plug, metal
2 x flat neoprene seals for blanking plugs

Cable fittings: analog models

2 x M25 cable glands, IP68, polyamide, cable Ø 8-12 mm
2 x M16 cable glands, IP68, cable Ø 7-10 mm
1 x M25 blanking plug, polyamide
1 x M16 blanking plug, polyamide
4 x flat neoprene seals for blanking plugs / cable glands

Accessories

Mounting bracket, 90° tilt-adjustable, stainless steel:

100 mm (for Cyclo IP65 02 & Cyclo IP65 03 28W) P/N 91611232

169 mm (for Cyclo IP65 04 & Cyclo IP65 03 54W) P/N 91611233

Clear front cover:

100 mm (for Cyclo IP65 02 & Cyclo IP65 03 28W) P/N 91611228

169 mm (for Cyclo IP65 04 & Cyclo IP65 03 54W) P/N 91611230

Opal front cover:

100 mm (for Cyclo IP65 02 & Cyclo IP65 03 28W) P/N 91611229

169 mm (for Cyclo IP65 04 & Cyclo IP65 03 54W) P/N 91611231

120 Ohm, 0.25 W DMX termination resistor. P/N 04150308

Martin 516 II DMX to 0-10V Converter. P/N 90758225

Ordering information*

28 watt tube models

Analog models, 2 x 28 W tubes, 230 V, 50/60 Hz

Cyclo IP65 02 28 W C P/N 90561100

Cyclo IP65 02 28 W O P/N 90561101

DMX models, 2 x 28 W tubes, 230 V, 50/60 Hz

Cyclo IP65 02 28W DMX C P/N 90561000

Cyclo IP65 02 28W DMX O P/N 90561001

Analog models, 3 x 28 W tubes, 230 V, 50/60 Hz

Cyclo IP65 03 28 W C P/N 90562100

Cyclo IP65 03 28 W O P/N 90562101

DMX models, 3 x 28 W tubes, 230 V, 50/60 Hz

Cyclo IP65 03 28W DMX C P/N 90562000

Cyclo IP65 03 28W DMX O P/N 90562001

Analog models, 4 x 28 W tubes, 230 V, 50/60 Hz

Cyclo IP65 04 28 W C P/N 90563100

Cyclo IP65 04 28 W O P/N 90563101

DMX models, 4 x 28 W tubes, 230 V, 50/60 Hz

Cyclo IP65 04 28W DMX C P/N 90563000

Cyclo IP65 04 28W DMX O P/N 90563001

54 watt tube models

Analog models, 3 x 54 W tubes, 230 V, 50/60 Hz

Cyclo IP65 03 54W C P/N 90565100

Cyclo IP65 03 54W O P/N 90565101

DMX models, 3 x 54 W tubes, 230 V, 50/60 Hz

Cyclo IP65 03 54W DMX C P/N 90565000

Cyclo IP65 03 54W DMX O P/N 90565001

*C and O denote clear and opal front cover models



Disposing of this product

Martin[®] products are supplied in compliance with Directive 2002/96/EC of the European Parliament and of the Council of the European Union on WEEE (Waste Electrical and Electronic Equipment), as amended by Directive 2003/108/EC, where applicable.

Help preserve the environment! Ensure that this product is recycled at the end of its life. Your supplier can give details of local arrangements for the disposal of Martin[®] products.

