

Mania EFX Series

user manual



EFX500



EFX600



EFX700



EFX800

Martin

Dimensions

Measurements are expressed in millimeters.

EFX500

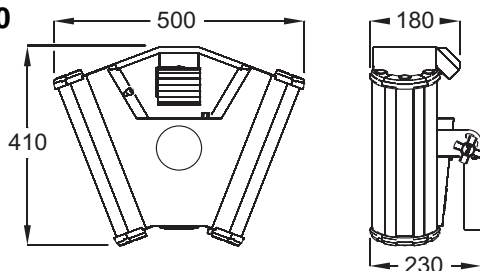

EFX600

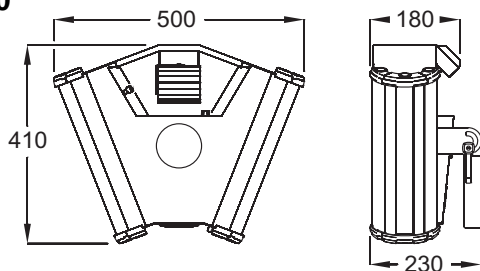

EFX700 & EFX800

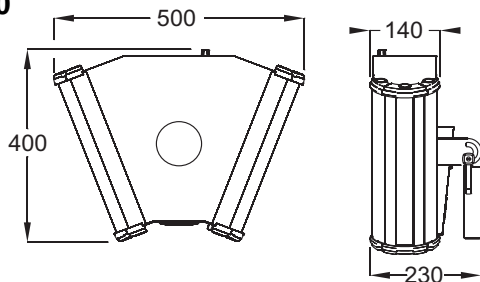

© 2006 Martin Professional A/S, Denmark. All rights reserved. No part of this manual may be reproduced, in any form or by any means, without permission in writing from Martin Professional A/S. Information subject to change without notice. Martin Professional A/S and all affiliated companies disclaim liability for any injury, damage, direct or indirect loss, consequential or economic loss or any other loss occasioned by the use of, inability to use or reliance on the information contained in this manual.

Contents

Overview	4
Introduction	5
Safety information	5
Unpacking	7
Installation	9
AC power	9
Physical installation	10
Creating a data link for DMX and synchronized operation	13
Gobo wheels	14
Operation	17
Getting started	17
Music trig, auto trig and DMX modes	17
Synchronized music trig and auto trig operation	18
DMX controller operation	19
Changing personality settings	23
Inverting effects movement	24
Error messages	25
Restriking the discharge lamp	25
Adjusting focus	26
Service and maintenance	27
Cleaning	27
Lamp replacement and adjustment	28
Replacing the main fuse	31
Firmware and hard boot uploads	32
Circuit board layouts	33
Troubleshooting	36
Control panel overview	37
Mania EFX500 DMX protocol	38
Mania EFX600 DMX protocol	41
Mania EFX700 DMX protocol	44
Mania EFX800 DMX protocol	46
Mania EFX Series specifications	49

Overview

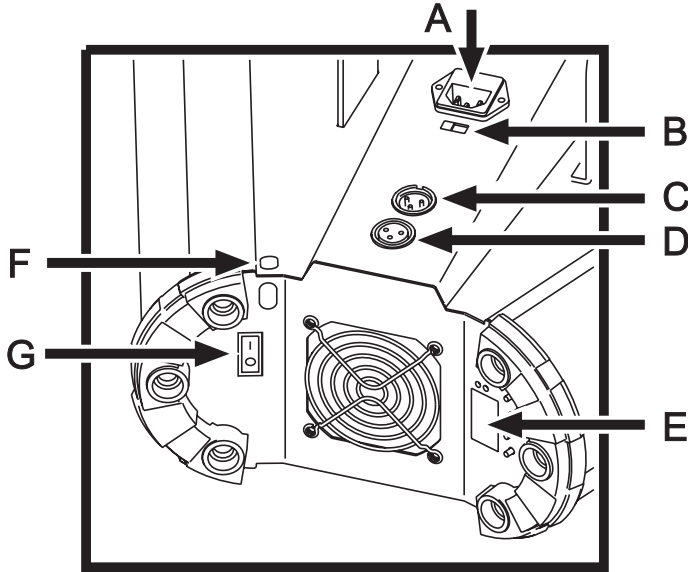

- A: Power inlet**
- B: Voltage selector switch (EFX600, EFX700 & EFX800: fitted to EU models only)**
- C: DMX in**
- D: DMX out**
- E: Display and control buttons**
- F: Safety cable attachment point**
- G: Power on/off switch**

Introduction

Thank you for selecting a dynamic lighting fixture from the Martin Mania EFX Series. This series consists of DJ lighting fixtures with a motorized rotating parabolic mirror dish and a motorized rotating gobo wheel (gobos are outlines or masks placed in a light beam). The fixtures project complex moving colored flower effects.

The **EFX500** and **EFX600** feature an additional mirror drum with motorized pan (swivel) and tilt (rotation) that further enhances beam dynamics. The **EFX800** features an additional motorized tilting (rotating) color paddlewheel that further enhances beam dynamics and color.

All Mania EFX fixtures offer the following features:

- Stand-alone single fixture and synchronized (master/slave) operation in auto and music triggering modes
- Adjustable music triggering sensitivity
- DMX control with two DMX modes: DMX mode 2 gives extended functionality on additional channels
- Adjustable focus

The **EFX500** uses a long-life 250 watt halogen lamp. **All other Mania EFX fixtures** use a long-life 150 watt discharge lamp.

Safety information

Warning! ***This product is not for household use. It presents risks of lethal or severe injury due to fire and heat, electric shock, ultraviolet radiation, lamp explosion and falls.***

This product presents risks of lethal or severe injury due to fire and heat, electric shock, ultraviolet radiation, lamp explosion, and falls. **Read this manual** before installing or powering the fixture, follow the safety precautions listed below and observe all warnings in this manual and on the fixture. If you have any questions about how to operate the fixture safely, please contact your Martin dealer or call the Martin 24-hour service hotline.

Protecting yourself and others from electric shock

- Ensure that the fixture is electrically connected to ground (earth).

- Check the fixture's voltage setting switch (if fitted) and serial number label before applying power. Only use the fixture if the fixture's voltage setting matches your local AC power voltage.
- Disconnect the fixture from AC power before removing or installing the lamp, fuse, or any part, and when not in use.
- Use only a source of AC power that complies with local building and electrical codes and has both overload and ground-fault (earth leakage) protection.
- Refer all service not described in this manual to a Martin service technician.
- Do not expose the fixture to rain or moisture.
- Do not operate the fixture if any covers or components are missing, damaged or deformed.
- Do not use the product if the power cable is damaged. Replace the cable with a Martin item only (available from your Martin dealer).

Protecting yourself and others from burns and fire

Warning! *Hot lamp. The exterior of the fixture can become hot. Allow to cool for at least 10 minutes before handling or opening.*

- Surface temperature under steady state condition = 100°C (212° F).
- Do not operate the fixture if the ambient temperature (T_a) exceeds 40° C (104° F).
- Never attempt to bypass the thermostatic switch or fuses. Always replace defective fuses with ones of the specified type and rating.
- See serial label for replacement fuse size and lamp type.
- Keep all combustible materials (for example fabric, wood, paper) at least 0.3 meters (4 inches) away from the fixture. Keep flammable materials well away from the fixture.
- Do not illuminate surfaces within 1 meter (3.3 feet) of the fixture.
- Provide a minimum clearance of 0.1 meters (4 inches) around fans and air vents and ensure that air flow through and around vents is free and unobstructed.
- Never place filters or other materials over the lens or in the optical path.
- Do not look directly into the light.
- Change the lamp immediately if it becomes damaged or thermally deformed.
- Do not operate the fixture if any optical components or shields are missing, damaged or deformed: an unshielded discharge lamp emits dangerous UV radiation that can cause burns and eye injuries.
- Do not modify the fixture or install other than genuine Martin parts.

Preventing injuries due to falls

- When suspending the fixture above ground level, verify that the structure can hold at least 10 times the weight of all installed devices.
- Ensure that all external covers and rigging hardware are securely fastened and use an approved means of secondary attachment such as a safety cable.
- Block access below the work area and work from a stable platform whenever installing or removing the fixture.

Discharge lamp safety

- EFX600, EFX700 and EFX800 fixtures use a discharge lamp. If the quartz envelope of a discharge lamp is broken, the lamp releases a small quantity of mercury and other toxic gases. If a discharge lamp explodes in a confined area, ventilate thoroughly and evacuate if necessary. Wear non-porous safety gloves when handling a broken discharge lamp. Treat broken or used discharge lamps and used safety gloves as hazardous waste and send to a specialist for disposal.

Unpacking

Important! Do not lift or carry a fixture by holding the motor housing (if fitted) on the front of the fixture. It is not designed for this purpose. You could injure yourself or others, and you could cause damage that is not covered by the product guarantee.

The packing material is carefully designed to protect the fixture during shipment - always use it to transport the fixture.

Mania EFX fixtures are supplied with the following items:

- 3-wire power cable(s) with IEC power input connector.
- 5m (16.4 ft.) DMX cable.
- Mounting plate (installed).
- **EFX500** only: 250 watt halogen lamp (installed).
- **EFX600, EFX700** and **EFX800**: 150 watt discharge lamp (this is supplied separately to avoid damage during shipping and must be installed before use – see “*Installing a discharge lamp*” on page 30).
- **EFX800** only: paddlewheel shield for use during transport (installed).

Removing protective packaging

Important! *The EFX500 and EFX600 mirror drum is secured with packaging and white plastic ties for shipment. Wearing gloves to avoid cutting yourself on the mirrors, cut and remove the plastic ties. Check that the drum can be swivelled through 180° and rotated through 360° before operating the fixture. If it cannot, you may have missed one of the plastic ties.*

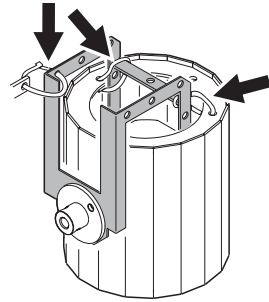

Remove the clear protective film from the mirror drum before operating the fixture.

The EFX800 is supplied with a protective shield installed over the paddlewheel for use when transporting the fixture. The shield is secured with one screw (arrowed in illustration). Before you operate the fixture, remove the screw, lift out the shield and store both items for future use.

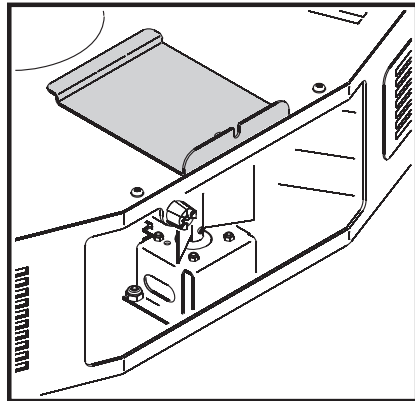
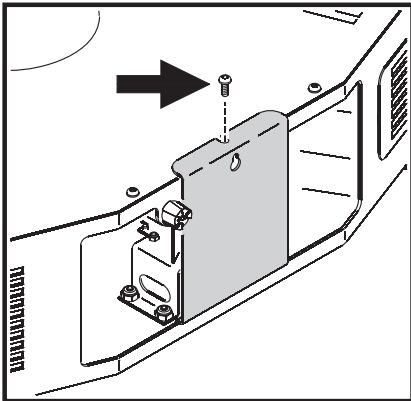

Reinstall the protective shield each time the fixture is transported.

Installation

AC power

Warning! *Ensure that the fixture's voltage setting matches your local AC power voltage before applying power.*

For protection from fire and electric shock, the fixture must be grounded (earthed). The power supply must have both overload and ground-fault (earth fault) protection.

Check that power cables are undamaged and rated for the current requirements of all connected devices before use.

Important! *Do not connect the fixture to a dimmer system, as this may cause damage that is not covered by the product guarantee.*

Mania EFX500 power settings

All Mania **EFX500** models must be set to 115 V, 60 Hz or 230 V, 50 Hz AC power using the red voltage selector switch on the connections panel.

- Set the switch so that 115 V is visible if you have 110-120 V, 60 Hz AC power.
- Set the switch so that 230 V is visible if you have 220-240 V, 50 Hz AC power.

Mania EFX600, EFX700 & EFX800 power settings

- Mania **EFX600, EFX700 and EFX800 EU models** can be set to 230 or 240 V, 50 Hz AC power using the switch on the connections panel. Use the 230 V setting if you have 220-230 V power, and use the 240 V setting if you have 230-240 V.
- Mania **EFX600, EFX700 and EFX800 US models** do not have a voltage selector switch and are supplied set up for 110-120 V, 60 Hz AC power.

Warning! *Do not operate the fixture if local AC power voltage is outside the range specified for the fixture.*

Power plugs

Mania EFX fixtures are supplied with power cables to match most local power outlet sockets (see “*Included items*” on page 51), but if there is no power plug that matches your socket type, install a suitable grounding-type (earthed) power plug on the power cable. Consult a qualified electrician if you have any doubts about proper installation.

Follow the power plug manufacturer’s instructions, connecting the appropriate wires to ground (earth), live, and neutral. The table below shows some common wire identification schemes.

Function	Wire (EU)	Wire (US)	Marking	Screw color
live	brown	black	“L”	yellow or brass
neutral	blue	white	“N”	silver
ground (earth)	yellow/green	green		green

Table 1: Cord cap wiring

Physical installation

Each Mania EFX fixture must be either:

- fastened to an overhead structure by means of its mounting plate and a Martin rigging clamp (available from your Martin dealer), or
- fastened to a surface by means of its mounting plate and suitable bolts.

Do not install the fixture by any other means, as this can cause the fixture to overheat.

Ensure that the mounting structure or surface and all fasteners used can support at least 10 times the weight of all installed fixtures, clamps, cables, auxiliary equipment, etc.

Ensure that the fixture is located:

- at least 1 meter (3.3 ft.) away from the surface to be illuminated,
- at least 0.1 meters (4 in.) from any combustible materials (wood, fabric, paper, etc.) and
- well away from any flammable materials.

Ensure that the clearance around the fan and air vents is at least 0.1 meters (4 in.) and that airflow is free and unobstructed.

Warning! *Block access below the work area and work from a stable platform when installing or servicing the fixture.*

Always use a secure means of secondary attachment that can hold at least 10 times the weight of the fixture, looping it through the attachment point shown at F in “Overview” on page 4. Do not simply pass the secondary attachment around the mounting plate, as this will leave the fixture unsecured.

Beam angles and fixture orientation

The fixtures in the Mania EFX series have different optical configurations. Referring to the illustration below will help you decide how to orient your fixture.

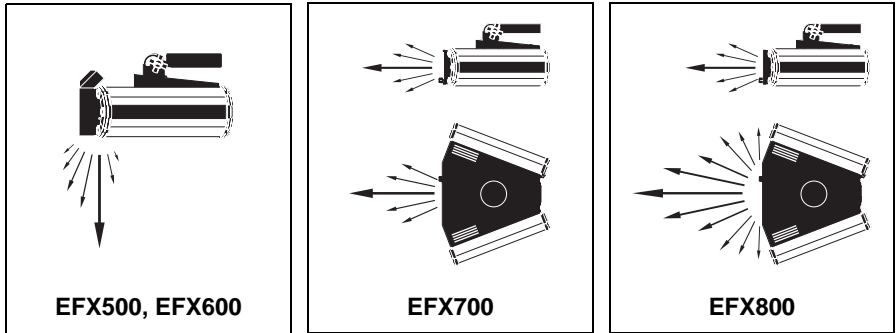

Surface mounting

To mount the fixture on a surface, you will need four grade 8.8 (minimum) 8mm diameter, 13mm head hex screwbolts (or similar type fasteners of the same grade and size) and an eyebolt for the safety cable.

Installing the mounting plate separately

Surface mounting is easiest if you detach the mounting plate from the fixture, bolt the mounting plate to the surface, and then reattach the fixture. If you choose this method, access for reattachment and adjustment can be easier if you remove the swivel locks and replace them with two M8 hexagonal lock nuts (P/N 08132701). Install an eyebolt and safety attachment once the fixture is mounted.

Installing the fixture and mounting plate as a unit

If you prefer to install the fixture and mounting plate without separating them:

1. Using the inside back cover of this manual as a guide, drill three holes in the positions marked **A**.

2. Screw three grade 8.8 (minimum) 8mm diameter, 13mm head hex screwbolts or bolts into the holes at **A**, but do not tighten them fully –allow enough clearance between the bolt head and surface for the 3mm thick mounting plate.

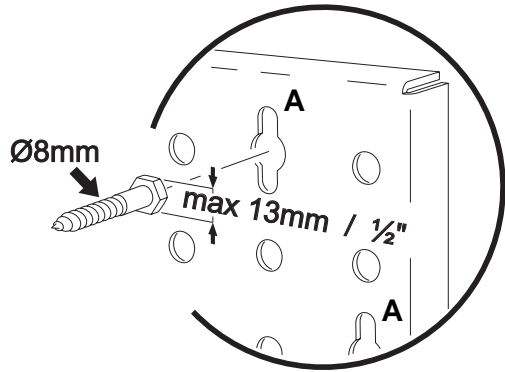

3. Fold the mounting plate so that it lies flat against the back of the fixture and tighten the swivel locks. For easier access for adjustment, it is possible to remove the swivel locks and replace them with two M8 hexagonal lock nuts, P/N 08132701).
4. Hold the fixture up to the surface so that the screwbolt heads pass through the centers of the keyholes **A** in the mounting plate, and slide the fixture to engage the screwbolt heads in the mounting plate.
5. Using one of the remaining holes in the mounting plate as a guide, mark a position for a fourth hole to accept a screwbolt that will lock the fixture in place.
6. Remove the fixture from the surface, drill the fourth hole and replace the fixture on the surface as described in point 4 above. Screw the fourth screwbolt through the mounting plate into the surface to lock the fixture in place, using a washer on the screwbolt if necessary.
7. Install an eyebolt and safety attachment once the fixture is mounted.

Overhead mounting

To hang a fixture on an overhead structure:

1. If using a rigging clamp, ensure that the clamp is undamaged and can bear at least 10 times the fixture's weight. Bolt the clamp securely to the fixture's mounting plate with a grade 8.8 (minimum) M12 bolt and lock nut through one of the 13 mm holes provided, or as recommended by the clamp manufacturer. The clamp must be attached centrally in the mounting plate to distribute the load evenly.

2. Working from a stable platform, clamp or fasten the fixture to the structure.
3. Install a safety cable that can hold at least 10 times the weight of the fixture.
4. Loosen the swivel locks, tilt the fixture to the desired angle, and retighten.

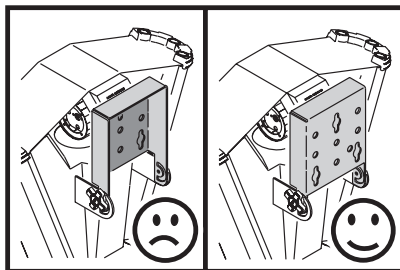

Important! *Check to make sure that the EFX500 and EFX600 mirror drum cable does not rub on the mounting plate. If necessary, reverse the mounting plate (see illustration).*

Creating a data link for DMX and synchronized operation

You need a serial data link to:

- run light shows on one or more fixtures using a DMX controller, or
- run synchronized light shows on two or more fixtures (master/slave operation).

Fixtures on a serial data link must be daisy-chained in one single line, maximum 500 meters (1640 ft.) long, with maximum 32 fixtures on the link. If you wish to exceed 32 fixtures or 500 meters, or to split the link into branches, use an optically isolated amplifier-splitter such as the Martin RS-485 Opto-Splitter (P/N 90758060).

Reliable data connection requires suitable cable. Standard microphone cable cannot transmit DMX data reliably over long runs. For best results, use cable with at least one twisted pair specifically designed for RS-485 applications. Your Martin dealer can supply suitable high quality cable in various lengths.

Connecting the serial data link

The Mania EFX has XLR data connectors, wired with pin 1 to ground, pin 2 to signal - (cold), and pin 3 to signal + (hot). This is the standard configuration for DMX devices.

One or more adaptor cables may be required to connect a Mania EFX fixture to the controller and/or other types of fixture, because some devices may have 5-pin XLR connectors, and others may have reversed

signal polarity (pin 2 hot and pin 3 cold). Connector polarity is normally specified on the device or in the device's user manual.

5-pin to 3-pin Adaptor	3-pin to 5-pin Adaptor	3-pin to 3-pin Phase-Reversing Adaptor	Male Termination Plug	Female DMX Termination Plug																																										
<table> <tr> <td>Male</td> <td>Female</td> </tr> <tr> <td>1</td> <td>1</td> </tr> <tr> <td>2</td> <td>2</td> </tr> <tr> <td>3</td> <td>3</td> </tr> <tr> <td>4</td> <td>4</td> </tr> <tr> <td>5</td> <td>5</td> </tr> </table>	Male	Female	1	1	2	2	3	3	4	4	5	5	<table> <tr> <td>Male</td> <td>Female</td> </tr> <tr> <td>1</td> <td>1</td> </tr> <tr> <td>2</td> <td>2</td> </tr> <tr> <td>3</td> <td>3</td> </tr> <tr> <td></td> <td>4</td> </tr> <tr> <td></td> <td>5</td> </tr> </table>	Male	Female	1	1	2	2	3	3		4		5	<table> <tr> <td>Male</td> <td>Female</td> </tr> <tr> <td>1</td> <td>1</td> </tr> <tr> <td>2</td> <td>2</td> </tr> <tr> <td>3</td> <td>3</td> </tr> </table>	Male	Female	1	1	2	2	3	3	<table> <tr> <td>Male XLR</td> </tr> <tr> <td>1</td> </tr> <tr> <td>2</td> </tr> <tr> <td>3</td> </tr> <tr> <td>120 Ohm</td> </tr> </table>	Male XLR	1	2	3	120 Ohm	<table> <tr> <td>Female XLR</td> </tr> <tr> <td>1</td> </tr> <tr> <td>2</td> </tr> <tr> <td>3</td> </tr> <tr> <td>120 Ohm</td> </tr> </table>	Female XLR	1	2	3	120 Ohm
Male	Female																																													
1	1																																													
2	2																																													
3	3																																													
4	4																																													
5	5																																													
Male	Female																																													
1	1																																													
2	2																																													
3	3																																													
	4																																													
	5																																													
Male	Female																																													
1	1																																													
2	2																																													
3	3																																													
Male XLR																																														
1																																														
2																																														
3																																														
120 Ohm																																														
Female XLR																																														
1																																														
2																																														
3																																														
120 Ohm																																														
P/N 11820005	P/N 11820004	P/N 11820006	P/N 91613017	P/N 91613018																																										

DMX connectors and polarity

To connect the data link:

1. Power all devices off.
2. If you intend to use a DMX controller, run a data cable from the DMX controller's data output to the first fixture's data IN socket. If the controller has a 5-pin output, use a 5-pin male to 3-pin female adaptor cable (P/N 11820005).
3. If you intend to run fixtures in master/slave operation, insert a female DMX termination plug (P/N 91613018) in the first fixture's data IN socket.
4. Plug a data cable into the OUT socket of the first fixture and the IN socket of the next one. Continue connecting up to 32 Mania EFXs output-to-input.
5. Terminate the link by inserting a male termination plug (P/N 91613017) into the data output of the last fixture. A termination plug is simply an XLR connector with a 120 Ohm, 0.25 W resistor soldered across pins 2 and 3.

Gobo wheels

All Mania EFX fixtures contain a gobo wheel. Note that it is the whole wheel, and not the individual gobos, that rotates. Rotating gobo image effects are created by the mirror dish.

- The **EFX500** has 11 colored gobos plus blackout.
- The **EFX600** has 12 colored gobos.
- The **EFX700** has 12 colored gobos.
- The **EFX800** has 12 gobos. Color is provided by the color paddlewheel.

The Mania **EFX500** contains the gobo wheel shown below.

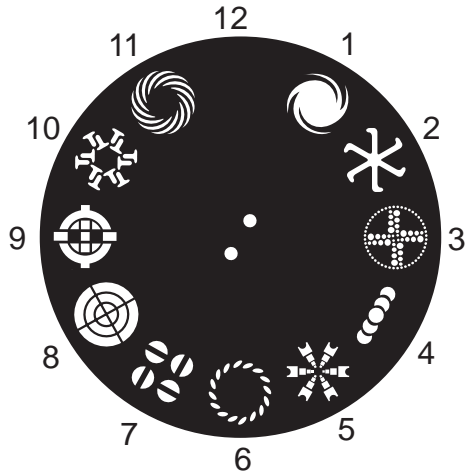

EFX500 Gobo wheel

The Mania **EFX600** contains the gobo wheel shown below.

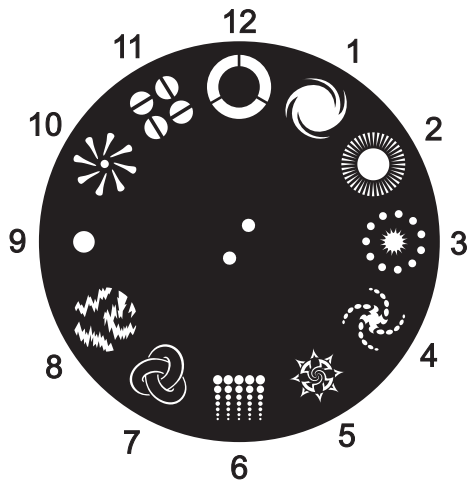

EFX600 Gobo wheel

The Mania **EFX700** contains the gobo wheel shown below.

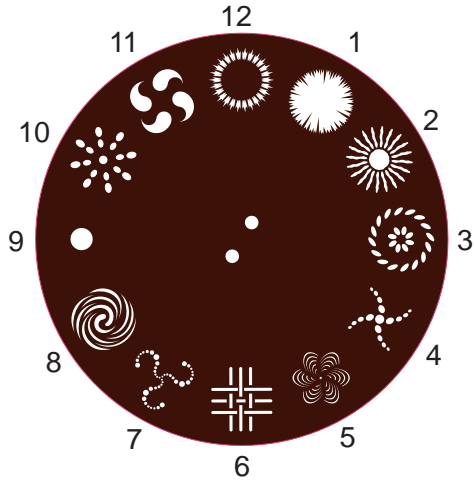

EFX700 Gobo wheel

The Mania **EFX800** contains the gobo wheel shown below.

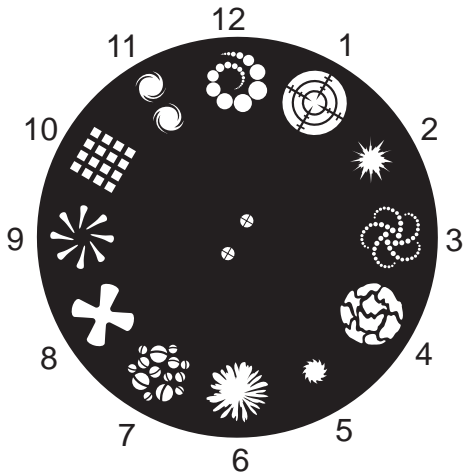

EFX800 Gobo wheel

Operation

Getting started

Mania EFX fixtures are supplied in DMX mode with DMX address set to 1. If you want to operate a fixture without a DMX controller, you need to set it to music trig or auto trig mode before use (see “*Selecting DMX, music trig or auto trig operating modes*” on page 18).

Powering on

Once the fixture is correctly and safely installed, power on at the fixture’s power on/off switch. The fixture will start up and reset.

If the fixture resets successfully, the software version installed will appear in the fixture’s display. For example, if software version 1.00 is installed, the message **100** should appear in the display.

Once the fixture has reset, the fixture will display either its DMX address, **901** (music trig mode) or **900** (auto trig mode).

If any other message is displayed, the fixture has detected an error (see “*Error messages*” on page 25). If this occurs, switch off, wait a few seconds and switch on again. If the error message appears again, consult your Martin dealer.

Music trig, auto trig and DMX modes

Mania EFX fixtures have three main operating modes:

Music trig mode: In this mode, lighting effects are triggered by music intensity. Multiple fixtures can be synchronized if one master fixture is set to music trig mode and the other fixtures are set to DMX mode.

Auto trig mode: In this mode, the fixture runs a factory-set dynamic light show that uses all the fixture’s effects in a random program. Multiple fixtures can be synchronized if one master fixture is set to auto trig mode and the other fixtures are set to DMX mode.

DMX mode: In DMX mode, fixtures receive control instructions via the serial data link. They will respond to control signals from a DMX controller (or from another fixture set as master).

Selecting DMX, music trig or auto trig operating modes

Fixtures are supplied set to DMX mode with DMX address set to 1. If you intend to operate the fixture without a DMX controller, you need to set the fixture to music trig or auto trig mode.

To switch between DMX, auto trig and music trig modes:

1. Apply power to the fixture and wait while it resets. If the fixture is in DMX mode, the display will show the fixture's DMX address.
2. Press the [Mode] button once. The fixture enters auto trig mode and **900** appears in the display.
3. Press the [Mode] button again once. The fixture enters music trig mode, and **90 1** appears in the display.
4. Press the [Mode] button again once to return to DMX mode. The fixture's DMX address appears in the display.

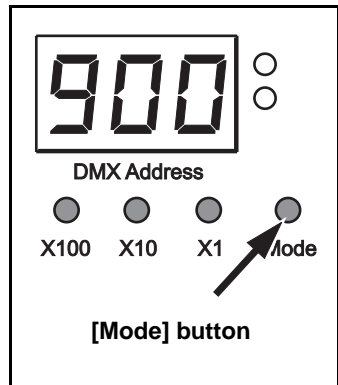

The fixture will return to the mode you have set when it is powered off and on.

If you set the fixture to music trig mode but it does not respond satisfactorily to the music beat, adjust the music trig sensitivity level (see “*Adjusting music trig sensitivity*” on page 23).

Synchronized music trig and auto trig operation

You can set multiple fixtures on a serial data link to respond together to a music trig or auto trig signal from one fixture. This feature allows synchronized operation without a DMX controller. The fixture sending the signal is the ‘master’ fixture and the fixtures that receive the signal are the ‘slave’ fixtures.

Important! *Set only one fixture as master: damage can occur if two masters, or a master and a DMX controller, are linked.*

Setting up synchronized operation

To set up fixtures for synchronized operation:

1. Ensure that all fixtures on the data link are in DMX mode.
2. Select one fixture to be the master and set it to auto trig or music trig mode (see "*Selecting DMX, music trig or auto trig operating modes*" on page 18)
3. When a slave fixture receives signals from the master, it will automatically begin operating in slave mode. **9 10** will appear in its display and the green Data LED will light to show that the fixture is receiving control data.

Slave mode

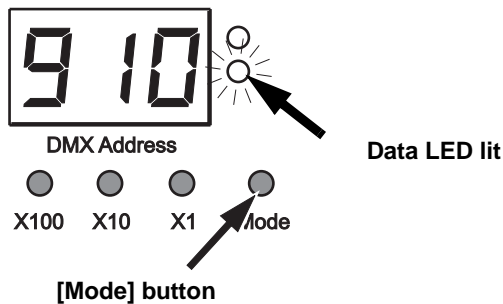

Fixtures return to their DMX/auto trig/music trig settings when powered off and on, so you should only need to set fixtures as masters/slaves once.

DMX controller operation

Setting DMX mode 1 or 2

Two DMX modes are available: DMX mode 1 (normal) and DMX mode 2 (extended). Mode 2 uses two extra DMX channels that allow you to select pre-programmed macros and set the speed of effects movement from the DMX controller. The fixture is supplied set to DMX mode 2.

- The **EFX500** uses seven DMX channels in DMX mode 1 and nine channels in DMX mode 2.
- The **EFX600** uses six DMX channels in DMX mode 1 and eight channels in DMX mode 2.
- The **EFX700** uses four channels in DMX mode 1 and six channels in DMX mode 2.

- The **EFX800** uses five DMX channels in DMX mode 1 and seven channels in DMX mode 2

To toggle between DMX modes 1 and 2:

1. Apply power to the fixture and wait for the fixture to reset.
2. Hold the [Mode] button pressed in for 5 seconds to enter the fixture control menu.
3. Press the [X100] button repeatedly until **0** appears in the left of the display. Press the [X1] button to toggle between **1** (to set DMX mode 1) and **2** (to set DMX mode 2) in the right of the display.
4. Press the [Mode] button again to save your setting.

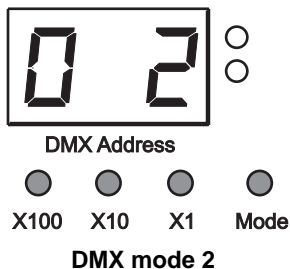

Setting DMX addresses

If you intend to use a DMX controller, you will need to set the DMX address for each fixture. The DMX address, also known as the start channel, is the first channel used to receive instructions from the controller. It is set using the three addressing buttons on the fixture's control panel.

For individual control, each fixture must be assigned its own DMX address and control channels. Control channels must not overlap with those of other fixtures. Fixtures of the same type with the same DMX address will receive the same instructions and behave identically.

As an example, a Mania EFX500 set to DMX mode 2 will use 9 channels. If you give it DMX address 100, it will use channels 100, 101, 102, 103, 104, 105, 106, 107 and 108. Channel 109 is available for the next fixture.

The default factory-set DMX address is '1'. To set a fixture's DMX address:

1. Decide on suitable DMX addresses for all the fixtures on the data link (note that 512 channels are available in one DMX universe).
2. Apply power to the fixture and wait while it resets.

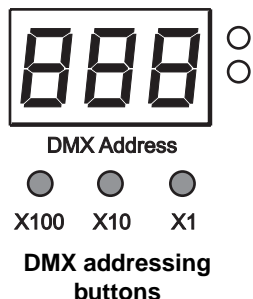

3. Use the three addressing buttons on the fixture's control panel to enter the DMX address. The [X1] button increases the last digit in the DMX address, the [X10] button increases the address by 10 and the [X100] button increases the address by 100.

Fixtures remember their DMX address when they are powered off and on.

DMX control options

See also the DMX protocols starting on page 38 for an overview of DMX commands and channels.

Control options

In **DMX modes 1 and 2**, the following functions can be controlled on **all models**:

Strobe effect: A strobe effect with variable flash rate can be selected.

Auto trig: While in DMX mode, the Mania EFX can be remotely set to auto trig.

Reset: All effects can be reset to their index positions from the controller using channel 1. The reset command must be sent for 5 seconds before it takes effect.

When a fixture is reset via DMX, **800** should appear in the digital display.

Dimming: The Mania **EFX500** can be dimmed from 0% (blackout) up to 100% intensity using channel 2. **All other Mania EFX fixtures** can be dimmed from 0% to 100% using the shutter on channel 1.

Gobo wheel position, rotation and music trig: The gobo wheel can be positioned to project one of the gobos (or at blackout on the EFX500). The gobo wheel can also be spun in either direction or set to music trig, in which gobos change with the music beat.

Mirror dish rotation and music trig: The mirror dish can be spun in either direction for dynamic projection effects or set to music trig.

In **DMX mode 2**, the following additional functions can be controlled on two extra channels:

Macros: On the first extra channel, you can select one of twelve factory-set macros. Macros are pre-programmed dynamic shows that use all the fixture's effects.

Effect speed: On the second extra channel, you can either select the speed at which effects change or select tracking. Selecting a speed allows you to adjust fade times when using DMX controllers that do not

feature fade time programming (a fade time is the time taken for effects to change from one scene to the next). If you select tracking, the DMX controller defines fade times.

EFX500 and EFX600 models only

Pan: The mirror drum pans (swivels) approx. 180°. A pan position can be selected, pan can be set to narrow or wide shake, or pan can be set to music trig.

Tilt: The mirror drum tilts (rotates) 360°. The drum can be held in a stationary position, set to rotate in either direction, set to narrow or wide shake, or set to music trig.

EFX800 models only

Tilt: The color paddlewheel tilts (rotates) 360°. The paddlewheel can be held in a stationary position, set to rotate in either direction, set to narrow or wide shake, or set to music trig.

Unsure about speed and tracking?

Set the fixture to tracking if you are using programmed fade times or macros on your DMX controller. Select an effects speed if you are *not* using programmed fade times or macros on your DMX controller.

However, if you are using fade times on your controller and have set the fixture to tracking, but effects movement is rough and irregular, setting fade times on your controller to zero and selecting an effects speed may give smoother movement.

Effects movement is set to 'tracking' if the fixture is in DMX mode 1 and by default.

DMX signal indicator

When a Mania EFX fixture receives a valid DMX signal, the green Data LED will light to show that the fixture is receiving control data.

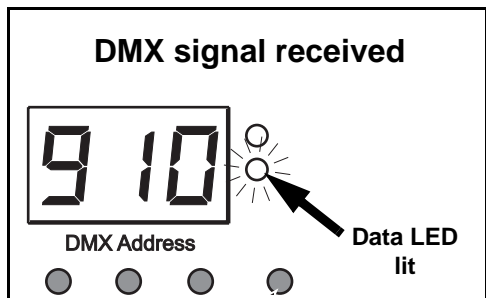

Changing personality settings

You can change certain personality settings using the buttons on the control panel:

- on **all models**, you can adjust music trig sensitivity
- on the **EFX500** and **EFX600**, you can invert mirror drum rotation
- on the **EFX800**, you can invert color paddlewheel rotation

To change these personality settings:

- Hold the [Mode] button pressed in for 5 seconds to access the control menu.
- Use the [X100] button to select the personality feature.
- Use the [X1] button to change the setting for that feature.

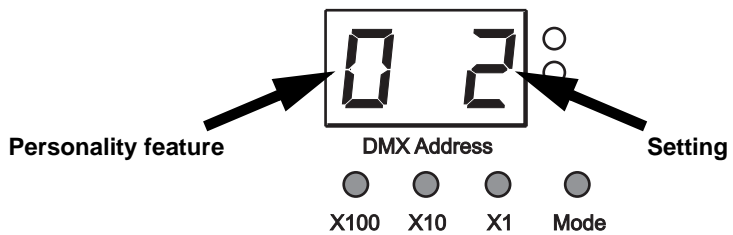

Adjusting music trig sensitivity

The music trig sensitivity can be adjusted on all models for optimum synchronization with the music. To adjust sensitivity:

1. With the fixture powered on and in music trig mode, play a typical music track at typical volume for your location.
2. Hold the [Mode] button on the control panel pressed in for 5 seconds to enter the control menu.
3. Press the [X100] button repeatedly until **3** appears on the left of the display.
4. Press the [X1] button to select a music trig sensitivity setting on the right of the display from **1** (minimum sensitivity) to **9** (maximum sensitivity). The default setting is **5**.
5. Press the [Mode] button again to save your setting and exit the control menu.

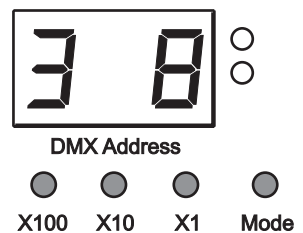

Inverting effects movement

You can create symmetrical action across multiple **EFX500**, **EFX600** and **EFX800** fixtures in synchronized and DMX operation by inverting the effects movement on some fixtures so that they 'mirror' the action of others. When one fixture tilts left, for example, a fixture on the other side of the dance floor can be set to tilt right.

Inverting tilt on the EFX500, EFX600 and EFX800

To invert tilt (mirror drum rotation on the EFX500 and EFX600, color paddlewheel rotation on the EFX800):

1. Power the fixture on.
2. Hold the [Mode] button on the control panel pressed in for 5 seconds to enter the control menu.
3. Press the [X100] button repeatedly until **2** appears on the left of the display.
4. Press the [X1] button to change the tilt setting on the right of the display from **0** (normal tilt) to **1** (inverted tilt).
5. Press the [Mode] button again to save your setting and exit the control menu.

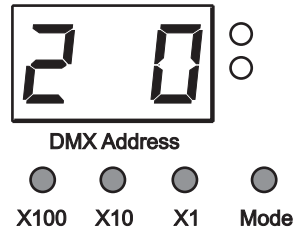

Inverting pan on the EFX500 and EFX600

To invert pan (mirror drum swivel) on EFX500 and EFX600 fixtures:

1. Power the fixture on.
2. Hold the [Mode] button on the control panel pressed in for 5 seconds to enter the control menu.
3. Press the [X100] button repeatedly until **1** appears on the left of the display.
4. Press the [X1] button to change the pan setting on the right of the display from **0** (normal pan) to **1** (inverted pan).
5. Press the [Mode] button again to save your setting and exit the control menu.

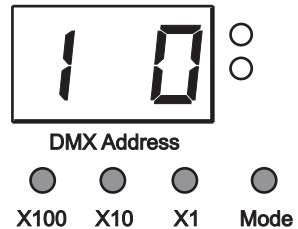

Error messages

In the event of an error, the following messages appear in the fixture display:

701 Gobo wheel error (**all fixtures**). There is a problem with the gobo wheel positioning system.

702 Hot restrike protection (**EFX600, EFX700 and EFX800**). You have tried to restrike a lamp by DMX within 8 minutes of extinguishing the lamp via DMX.

703 Color paddlewheel error (**EFX800**). There is a problem with the color paddlewheel positioning system.

If an error message is displayed, try powering the fixture off and then on again to reset it. If the problem persists, contact your Martin dealer.

Restriking the discharge lamp

If the discharge lamp in the **EFX600, EFX700 and EFX800** is powered off via DMX during operation, you must wait eight minutes before the lamp can be restruck.

If you try to strike the lamp anyway, the message **702** will appear in the display.

Adjusting focus

Focus can be adjusted from approx. 2 meters (6.6 ft.) to approx. 20 meters (66 ft.) using the focus adjustment knob.

On **EFX500** and **EFX600** fixtures, the focus adjustment knob is close to the lens aperture in the mirror drum cutout.



EFX500, EFX600

On **EFX700** and **EFX800** fixtures, the focus adjustment knob is close to the beam aperture on the front plate.

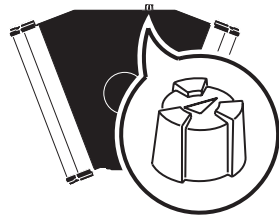

EFX700, EFX800

Service and maintenance

Mania EFX fixtures require simple routine maintenance. The maintenance schedule depends heavily on the operating environment. Please consult a Martin service technician for recommendations.

Refer any service procedure not described here to a qualified technician.

Warning! *Disconnect the fixture from power and allow it to cool for at least 10 minutes before removing any cover.*

Cleaning

Important! *Excessive dust, grease, and smoke fluid buildup degrades performance and causes overheating and damage to the fixture that is not covered by the warranty. Check and, if necessary, clean fixtures at regular intervals.*

Cleaning the fan and air vents

To maintain adequate cooling, dust must be cleaned from the fan and air vents periodically.

1. Disconnect the fixture from power and allow it to cool for at least 10 minutes.
2. Loosen the lamp cover release thumbscrew and slide and lift the lamp cover out of the fixture housing. Let the cover hang on its safety strap.
3. Remove the four torx screws holding the main cover (see illustration on right) and slide and lift the cover out of the housing. Let the cover hang on its safety strap.
4. Remove dust and dirt from the fan blades and vent grills using a soft brush, cotton swab, vacuum, or compressed air.
5. Reinstall the main cover and lamp cover securely before reapplying power.

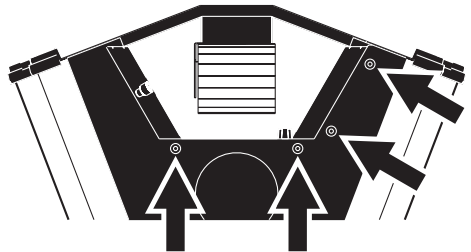

Cleaning optical components

Use care when cleaning optical components. The coated surfaces are fragile and even small scratches may be visible in the fixture's light output.

1. Disconnect the fixture from power and allow it to cool for at least 10 minutes.
2. Open the covers as described in "Cleaning the fan and air vents" above.
3. Blow or vacuum away loose dust. Remove dirt from lenses, gobos and mirror wheel with a soft cloth or cotton swabs wetted with isopropyl

- alcohol. Regular glass cleaner may also be used, but no residues may remain. To avoid scratches, do not rub. Instead, press repeatedly to lift dirt off surfaces.

4. Any remaining residues or streaking can be removed with distilled water. Mixing the water with a small amount of wetting agent such as Kodak Photoflo will help prevent streaking and spotting.
5. Dry with a clean, soft, lint-free cloth or compressed air.
6. Reinstall all covers before reapplying power.

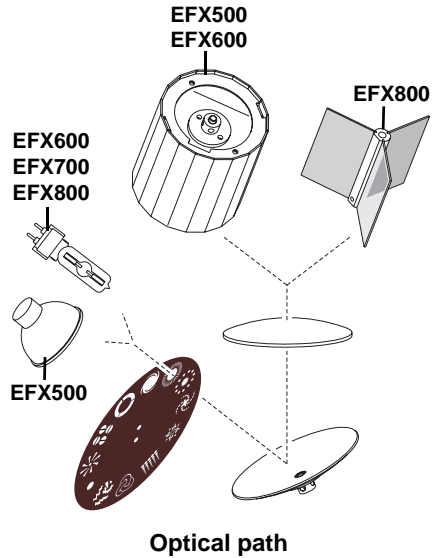

Lamp replacement and adjustment

Warning! *Wear safety glasses and gloves and allow the fixture to cool for at least 10 minutes before replacing the lamp.*

Halogen lamp (Mania EFX500)

The Mania **EFX500** uses a 250 watt halogen lamp. Replace the lamp when it reaches the average life specified by the manufacturer. The halogen lamp has an integral reflector and does not require adjustment when correctly installed.

Important! Use only this type of lamp. See “Accessories” on page 52 for details of replacement lamps. Installing any other lamp may damage the fixture.

Installing a halogen lamp

1. Disconnect the fixture from power and allow it to cool for at least 10 minutes.
2. Loosen the lamp cover release thumbscrew enough to slide and lift the lamp cover out of the fixture housing. The lamp cover is attached to the housing with a safety strap.
3. If replacing an old lamp, remove it together with its ceramic socket from the lampholder clip and, being careful not to strain any wires, gently pull the lamp off the socket.
4. Hold the new lamp by its base (do not touch any other part of the lamp). Push the lamp pins squarely into the ceramic socket.
5. If you touched the bulb, the reflector or any optical components, clean them with a clean, soft, lint-free cloth wetted with isopropyl alcohol and dry with a clean, soft, lint-free cloth or compressed air.
6. Replace the lamp and socket in the lampholder clip, ensuring that the reflector sits flat against its plate and is held securely in place. When installed correctly, the rim of the reflector locates under the heads of two stop screws so that the reflector is held firmly between these screws and the lampholder clip.
7. Close the lamp cover, checking that no wires are trapped, and retighten the thumbscrew.

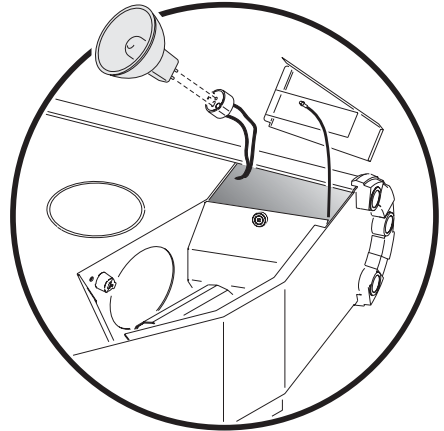

Discharge lamp (EFX600, EFX700 & EFX800)

The Mania **EFX600**, **EFX700** and **EFX800** use a 150 watt long-life discharge lamp.

For optimum lamp life, always allow discharge lamps to warm up for at least 5 minutes before dousing.

Restriking a discharge lamp

Note that, when a discharge lamp is powered off, it must be allowed to cool for 8 minutes before it is restruck.

Installing a discharge lamp

Warning! *Wear safety glasses and gloves and allow the fixture to cool for at least 10 minutes before replacing the lamp.*

1. Disconnect the fixture from power and allow it to cool for at least 10 minutes.
2. Loosen the screw holding the lamp cover (see illustration on right: EFX600 illustrated) and open the cover. The cover is attached to the housing with a safety strap.

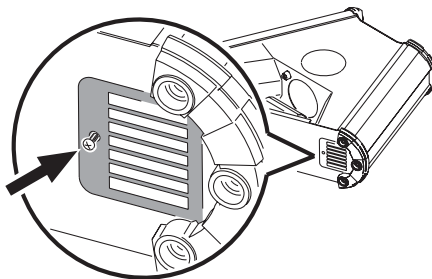

3. Loosen the four small screws (see illustration on right) holding the lampholder and pull the lampholder gently out of the fixture. Note which edge faces outwards, as the lampholder must be reinstalled in the same position.

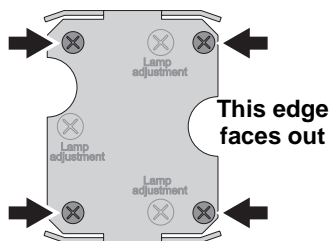

4. If replacing an old lamp, remove it from its ceramic socket.
5. Hold the new lamp by its base (do not touch any other part of the lamp). Push the lamp pins squarely into the socket.
6. If you touched the bulb, the reflector or any optical components, clean them with a clean, soft, lint-free cloth wetted with isopropyl alcohol and dry with a clean, soft, lint-free cloth or compressed air.

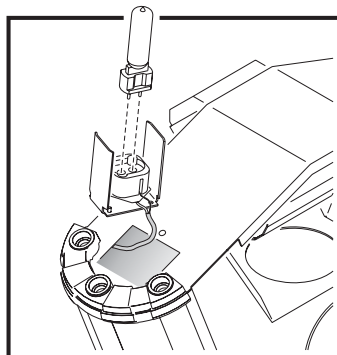

7. Replace the lampholder in the housing, making sure that the edge with the semicircular cutout in its center faces out towards the edge of the and reinstall the four screws. Close the lamp cover, checking that no wires are trapped, and replace the lamp cover screw.
8. Reapply power.

Discharge lamp adjustment

The discharge lamp alignment can be adjusted to optimize the projected image using the adjustment screws on the lampholder (see illustration on right). Experiment with turning the screws until the brightest part of the beam is centered in the projected images.

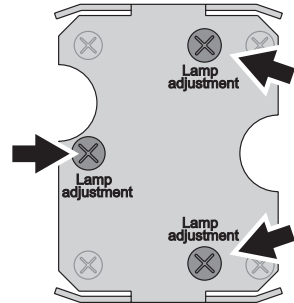

Replacing the main fuse

Mania EFX fixtures use a slow-blow fuse for protection against current overload. An indication that the fuse may have blown is that when power is applied and the lamp is switched on, no light is produced.

If the fuse blows repeatedly, there is probably a fault. Disconnect the fixture from power and data and contact a Martin service technician.

Never bypass the fuse or replace it with one of another type or rating.

To replace the main fuse:

1. Disconnect the power cable.
2. Pry open the fuse holder next to the power cable inlet with a flat-head screwdriver and remove the fuse.
3. Replace the fuse with one of the same type and rating. Fuse ratings are listed on serial number labels and under "*Electrical*" on page 50.
4. Replace the fuse holder before reapplying power.

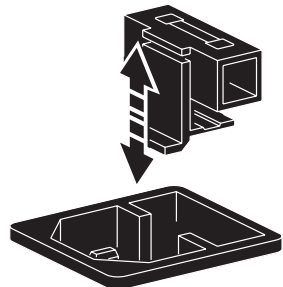

Firmware and hard boot uploads

It is possible to upload new firmware to via the data IN connector using, for example, an uploader such as the Martin MP-2 Uploader, or a PC using a Martin DABS interface device and suitable software. The latest firmware versions for Mania EFX fixtures can be downloaded from the Support area of the Martin website at <http://www.martin.com>

If a fixture will not accept normal firmware uploads, it can be forced to accept an upload by starting it in hard boot mode. To start in hard boot mode, hold both the [Mode] button and the [X100] button pressed in while powering on the fixture. When the fixture is in hard boot mode, the data LED blinks.

If you are not sure how to carry out uploads, your Martin dealer will be able to give advice or carry out the upload for you.

Circuit board layouts

EFX500 Main PCB, all models

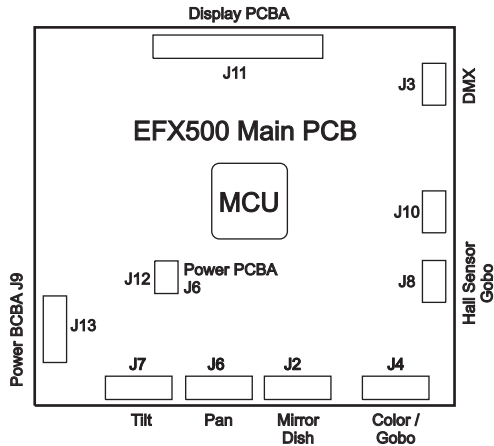

EFX600 Main PCB, all models

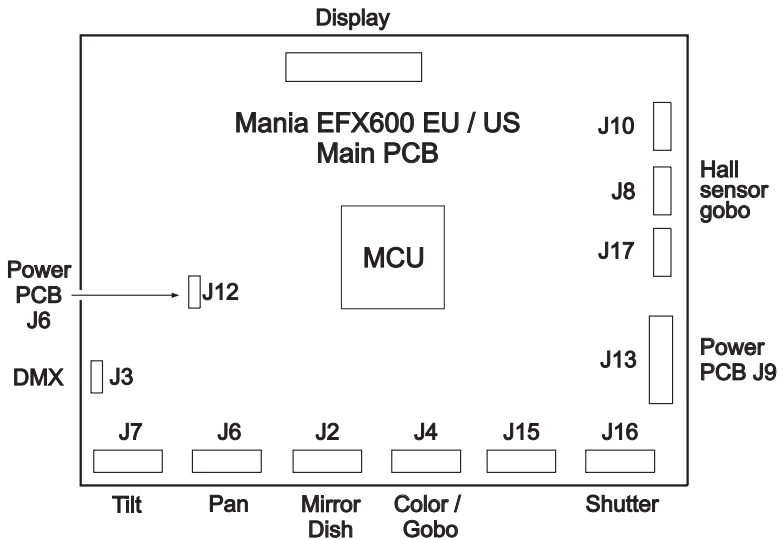

EFX700 Main PCB, all models

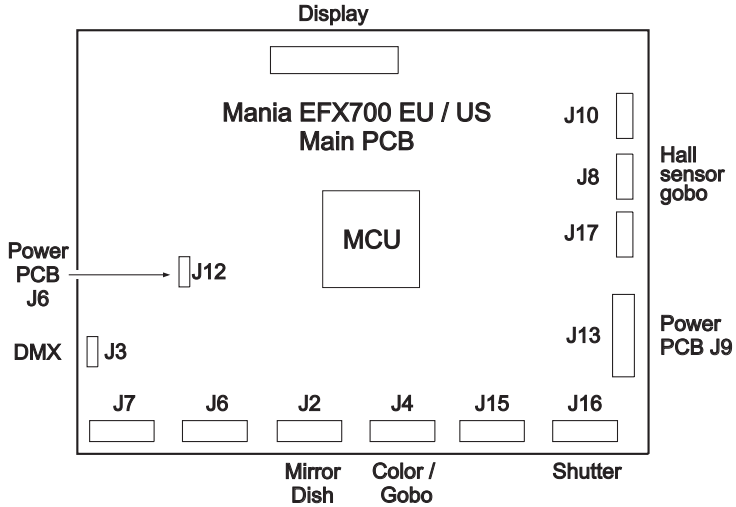

EFX800 Main PCB, all models

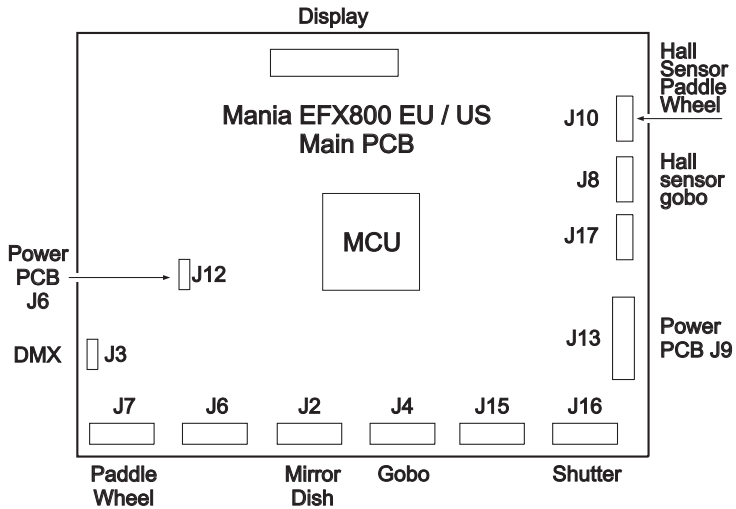

EFX500 Power PCB, all models

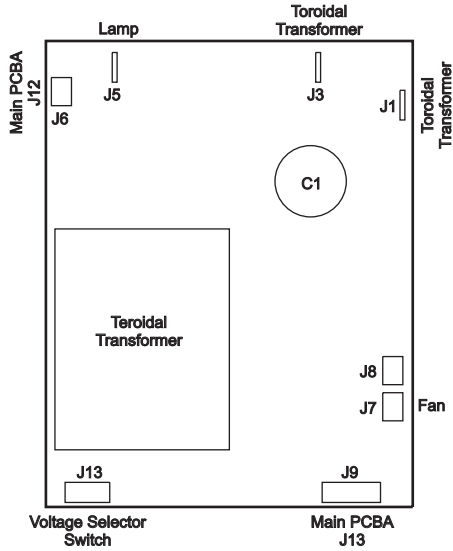

EFX600, EFX700 and EFX800 Power PCB

EU models

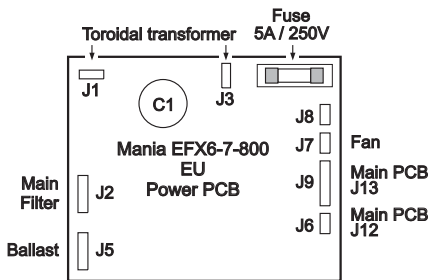

US models

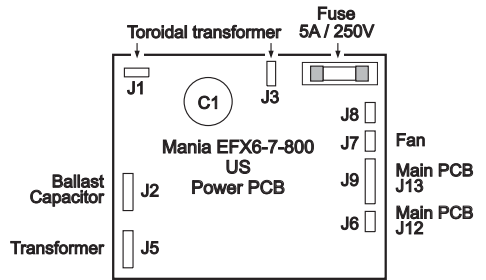

Troubleshooting

Problem	Possible cause(s)	Suggested remedy
No light	Shutter closed (EFX600, EFX700 & EFX800 using DMX control)	Open shutter via DMX
	No power to the fixture	Check connections
	Blown fuse	If power is applied and the lamp is switched on but does not light, check and replace fuse if necessary
	Burned out lamp	Install new lamp
	Fixture too hot	Allow to cool Improve airflow around fixture
No action in music trig mode	Sound too low to activate control circuit	Adjust music level sensitivity Increase music volume Move fixture closer to music source
No action in music trig and auto trig modes	Electrical malfunction	Refer to a Martin service technician
Unsatisfactory action in synchronized operation	Fixtures incorrectly linked	Check data link connections between fixtures
	More than one fixture set as master	Check that all slave fixtures are set to DMX mode
Poor action in a new fixture	Some transport packaging has not been removed	Remove all plastic ties from mirror drum until drum rotates freely
Fuse blows repeatedly	Electrical malfunction	Refer to a Martin service technician
EFX600, EFX700, EFX800: Impossible to restrike lamp after dousing via DMX.	8 minute hot restrike protection delay activated	Wait 8 minutes before restriking a hot discharge lamp
Fixtures reset correctly but behave erratically or do not respond during DMX or synchronized operation	Data link not terminated	Insert DMX termination plug in output of last fixture on link. In synchronized operation, insert DMX termination plug in input of first fixture

Control panel overview

EFX500 and EFX600 control panel settings

Personality feature		Setting*	
0	DMX mode	1	Mode 1 (normal)
		2	Mode 2 (extended)
1	Pan (mirror drum swivel) invert	0	Pan normal
		1	Pan inverted
2	Tilt (mirror drum rotation) invert	0	Tilt normal
		1	Tilt inverted
3	Music trig sensitivity**	1	Minimum
		↓	↓
		9	Maximum

EFX700 control panel settings

Personality feature		Setting*	
0	DMX mode	1	Mode 1 (normal)
		2	Mode 2 (extended)
3	Music trig sensitivity**	1	Minimum
		↓	↓
		9	Maximum

EFX800 control panel settings

Personality feature		Setting*	
0	DMX mode	1	Mode 1 (normal)
		2	Mode 2 (extended)
2	Tilt (color paddle-wheel rotation) invert	0	Tilt normal
		1	Tilt inverted
3	Music trig sensitivity**	1	Minimum
		↓	↓
		9	Maximum

* Default settings are shown in **bold type**.

** Music trig sensitivity is **6** by default.

Mania EFX500 DMX protocol

Channel	Value	Percent	Function
1	0 - 4	0 - 1	Strobe effect, auto trig, music trig, reset No function
	5 - 68	2 - 26	Strobe (fast to slow)
	69 - 100	27 - 39	Remote stand-alone, auto trig
	101 - 132	40 - 51	Remote stand-alone, music trig
	133 - 249	52 - 97	Reserved, no function
	250 - 255	98 - 100	Reset fixture (value must be held for 5 seconds)
	2	0 - 255	0 - 100
			Colored gobo wheel positions, gobo wheel rotation, gobo wheel music trig Full gobo positions
3	0 - 9	0 - 3	Gobo 1
	10 - 19	4 - 7	Gobo 2
	20 - 29	8 - 11	Gobo 3
	30 - 39	12 - 15	Gobo 4
	40 - 49	16 - 19	Gobo 5
	50 - 59	20 - 23	Gobo 6
	60 - 69	24 - 26	Gobo 7
	70 - 79	27 - 30	Gobo 8
	80 - 89	31 - 35	Gobo 9
	90 - 99	36 - 38	Gobo 10
	100 - 109	39 - 42	Gobo 11
	110 - 119	43 - 46	Gobo 12 (Blackout)
	120 - 175	47 - 68	Reserved (Blackout, gobo 12)
			Continuous Rotation
	176 - 207	69 - 81	Clockwise (fast → slow)
	208 - 239	82 - 93	Counterclockwise (slow → fast)
			Music function
240 - 244	94 - 95	Gobo wheel music trig fast	
245 - 249	96 - 97	Gobo wheel music trig slow	
250 - 255	98 - 100	Gobo wheel music trig dynamic	

Channel	Value	Percent	Function
4	0 - 1	0	Colored gobo wheel shake No function
	2 - 128	1 - 50	Narrow shake (slow → fast)
	129 - 255	51 - 100	Wide shake (slow → fast)
	Mirror dish rotation, shake and music trig		
5	0 - 1	0	Stop
	2 - 65	1 - 25	Counterclockwise rotation (fast → slow)
	66 - 129	26 - 50	Clockwise rotation (slow → fast)
	130 - 192	51 - 75	Shake (slow → fast)
	193 - 208	76 - 81	Random shake
	209 - 239	82 - 93	Reserved, stop
	240 - 244	94 - 95	Mirror dish music trig, fast
	245 - 249	96 - 97	Mirror dish music trig, slow
	250 - 255	98 - 100	Mirror dish music trig, dynamic
	6	Pan (mirror drum swivel) position, shake and music trig	
0		0	Maximum left pan
63		24	Neutral
127		50	Maximum right pan
128 - 182		51 - 71	Narrow shake (slow → fast)
183 - 239		72 - 93	Wide shake (slow → fast)
240 - 244		94 - 95	Music trig pan, fast
245 - 249		96 - 97	Music trig pan, slow
250 - 255		98 - 100	Music trig pan, dynamic
7	Tilt (mirror drum rotation) rotation, shake and music trig		
	0 - 1	0	No rotation
	2 - 63	1 - 24	Clockwise rotation (slow → fast)
	64 - 65	25	No rotation
	66 - 127	26 - 49	Counterclockwise rotation (fast → slow)
	128 - 129	50	No rotation
	130 - 184	51 - 72	Narrow shake (slow → fast)
	185 - 239	73 - 93	Wide shake (slow → fast)
	240 - 244	94 - 95	Mirror drum rotation music trig, fast
	245 - 249	96 - 97	Mirror drum rotation music trig, slow
	250 - 255	98 - 100	Mirror drum rotation music trig, dynamic

Channel	Value	Percent	Function
8*	0 - 15	0 - 5	Macros (DMX mode 2 only) No Macro
	16 - 31	6 - 11	Macro 1
	32 - 47	12 - 18	Macro 2
	48 - 63	19 - 24	Macro 3
	64 - 79	25 - 30	Macro 4
	80 - 95	31 - 37	Macro 5
	96 - 111	38 - 43	Macro 6
	112 - 127	44 - 49	Macro 7
	128 - 143	50 - 55	Macro 8
	144 - 159	56 - 62	Macro 9
	160 - 175	63 - 68	Macro 10
	176 - 191	69 - 74	Macro 11
	192 - 207	75 - 81	Macro 12
208 - 255	82 - 100	Reserved. No function	
9*	0 - 1	0	Effects speed (DMX mode 2 only) Tracking (default)
	2 - 255	1 - 100	Fast → slow

* Channels 8 and 9 are available in DMX mode 2 only. In DMX mode 1, effects speed is set to 'tracking'.

Mania EFX600 DMX protocol

Channel	Value	Percent	Function
1			Intensity, strobe effect, auto trig, reset, lamp off
	0 - 4	0 - 1	Blackout (shutter closed)
	5 - 122	2 - 47	Intensity 0-100%, lamp on
	123 - 129	48 - 50	Shutter open
	130 - 189	51 - 74	Strobe (fast to slow)
	190 - 199	75 - 78	Shutter closed
	200 - 209	79 - 82	Random strobe
	210 - 219	83 - 86	Remote stand-alone, auto trig
	220 - 239	87 - 94	Blackout (shutter closed)
	240 - 249	95 - 98	Reset fixture (value must be held for 5 seconds)
	250 - 255	99 - 100	Lamp off (value must be held for 5 seconds and channels 2 & 3 must be set to more than 252 / 99%). Note that there is an 8-minute delay before lamp can be restruck.
	2		
			Full gobo positions
0 - 9		0 - 3	Gobo 1
10 - 19		4 - 7	Gobo 2
20 - 29		8 - 11	Gobo 3
30 - 39		12 - 15	Gobo 4
40 - 49		16 - 19	Gobo 5
50 - 59		20 - 23	Gobo 6
60 - 69		24 - 26	Gobo 7
70 - 79		27 - 30	Gobo 8
80 - 89		31 - 35	Gobo 9
90 - 99		36 - 38	Gobo 10
100 - 109		39 - 42	Gobo 11
110 - 119		43 - 46	Gobo 12
120 - 175		47 - 68	Reserved (gobo 12)
			Continuous Rotation
176 - 207		69 - 81	Clockwise (fast → slow)
208 - 239		82 - 93	Counterclockwise (slow → fast)
			Music function
240 - 244		94 - 95	Gobo wheel music trig fast
245 - 249	96 - 97	Gobo wheel music trig slow	
250 - 255	98 - 100	Gobo wheel music trig dynamic	

Channel	Value	Percent	Function
3	0 - 1	0	Colored gobo wheel shake No function
	2 - 128	1 - 50	Narrow shake (slow → fast)
	129 - 255	51 - 100	Wide shake (slow → fast)
4	0 - 1	0	Mirror dish rotation, shake and music trig Stop
	2 - 65	1 - 25	Counterclockwise rotation (fast → slow)
	66 - 129	26 - 50	Clockwise rotation (slow → fast)
	130 - 192	51 - 75	Shake (various shakes)
	193 - 208	76 - 81	Random shake
	209 - 239	82 - 93	Reserved, stop
	240 - 244	94 - 95	Mirror dish music trig, fast
	245 - 249	96 - 97	Mirror dish music trig, slow
	250 - 255	98 - 100	Mirror dish music trig, dynamic
5	0	0	Pan (mirror drum swivel) position, shake and music trig Maximum left pan
	63	24	Neutral
	127	50	Maximum right pan
	128 - 182	51 - 71	Narrow shake (slow → fast)
	183 - 239	72 - 93	Wide shake (slow → fast)
	240 - 244	94 - 95	Music trig pan, fast
	245 - 249	96 - 97	Music trig pan, slow
	250 - 255	98 - 100	Music trig pan, dynamic
6	0 - 1	0	Tilt (mirror drum rotation) rotation, shake and music trig No rotation
	2 - 63	1 - 24	Clockwise rotation (slow → fast)
	64 - 65	25	No rotation
	66 - 127	26 - 49	Counterclockwise rotation (fast → slow)
	128 - 129	50	No rotation
	130 - 184	51 - 72	Narrow shake (slow → fast)
	185 - 239	73 - 93	Wide shake (slow → fast)
	240 - 244	94 - 95	Mirror drum rotation music trig, fast
	245 - 249	96 - 97	Mirror drum rotation music trig, slow
	250 - 255	98 - 100	Mirror drum rotation music trig, dynamic

Channel	Value	Percent	Function
7*	0 - 15	0 - 5	No Macro
	16 - 31	6 - 11	Macro 1
	32 - 47	12 - 18	Macro 2
	48 - 63	19 - 24	Macro 3
	64 - 79	25 - 30	Macro 4
	80 - 95	31 - 37	Macro 5
	96 - 111	38 - 43	Macro 6
	112 - 127	44 - 49	Macro 7
	128 - 143	50 - 55	Macro 8
	144 - 159	56 - 62	Macro 9
	160 - 175	63 - 68	Macro 10
	176 - 191	69 - 74	Macro 11
	192 - 207	75 - 81	Macro 12
208 - 255	82 - 100	Reserved. No function	
8*	0 - 1	0	Tracking (default)
	2 - 255	1 - 100	Fast → slow

* Channels 7 and 8 are available in DMX mode 2 only. In DMX mode 1, effects speed is set to 'tracking'.

Mania EFX700 DMX protocol

Channel	Value	Percent	Function
1			Intensity, strobe effect, auto trig, reset, lamp off
	0 - 4	0 - 1	Blackout (shutter closed)
	5 - 122	2 - 47	Intensity 0-100%, lamp on
	123 - 129	48 - 50	Shutter open
	130 - 189	51 - 74	Strobe (fast to slow)
	190 - 199	75 - 78	Shutter closed
	200 - 209	79 - 82	Random strobe
	210 - 219	83 - 86	Remote stand-alone, auto trig
	220 - 239	87 - 94	Blackout (shutter closed)
	240 - 249	95 - 98	Reset fixture (value must be held for 5 seconds)
	250 - 255	99 - 100	Lamp off (value must be held for 5 seconds and channels 2 & 3 must be set to more than 252 / 99%). Note that there is an 8-minute delay before lamp can be restruck.
	2		
			Full gobo positions
0 - 9		0 - 3	Gobo 1
10 - 19		4 - 7	Gobo 2
20 - 29		8 - 11	Gobo 3
30 - 39		12 - 15	Gobo 4
40 - 49		16 - 19	Gobo 5
50 - 59		20 - 23	Gobo 6
60 - 69		24 - 26	Gobo 7
70 - 79		27 - 30	Gobo 8
80 - 89		31 - 35	Gobo 9
90 - 99		36 - 38	Gobo 10
100 - 109		39 - 42	Gobo 11
110 - 119		43 - 46	Gobo 12
120 - 175		47 - 68	Reserved (gobo 12)
			Continuous Rotation
176 - 207		69 - 81	Clockwise (fast → slow)
208 - 239		82 - 93	Counterclockwise (slow → fast)
			Music function
240 - 244		94 - 95	Gobo wheel music trig fast
245 - 249	96 - 97	Gobo wheel music trig slow	
250 - 255	98 - 100	Gobo wheel music trig dynamic	

Channel	Value	Percent	Function
3	0 - 1	0	Colored gobo wheel shake No function
	2 - 128	1 - 50	Narrow shake (slow → fast)
	129 - 255	51 - 100	Wide shake (slow → fast)
	Mirror dish rotation, shake and music trig		
4	0 - 1	0	Stop
	2 - 65	1 - 25	Counterclockwise rotation (fast → slow)
	66 - 129	26 - 50	Clockwise rotation (slow → fast)
	130 - 192	51 - 75	Shake (various shakes)
	193 - 208	76 - 81	Random shake
	209 - 239	82 - 93	Reserved, stop
	240 - 244	94 - 95	Mirror dish music trig, fast
	245 - 249	96 - 97	Mirror dish music trig, slow
	250 - 255	98 - 100	Mirror dish music trig, dynamic
	5*	Macros (DMX mode 2 only)	
0 - 15		0 - 5	No Macro
16 - 31		6 - 11	Macro 1
32 - 47		12 - 18	Macro 2
48 - 63		19 - 24	Macro 3
64 - 79		25 - 30	Macro 4
80 - 95		31 - 37	Macro 5
96 - 111		38 - 43	Macro 6
112 - 127		44 - 49	Macro 7
128 - 143		50 - 55	Macro 8
144 - 159		56 - 62	Macro 9
160 - 175		63 - 68	Macro 10
176 - 191		69 - 74	Macro 11
192 - 207		75 - 81	Macro 12
208 - 255	82 - 100	Reserved. No function	
6*	Effects speed (DMX mode 2 only)		
	0 - 1	0	Tracking (default)
	2 - 255	1 - 100	Fast → slow

* Channels 5 and 6 are available in DMX mode 2 only. In DMX mode 1, effects speed is set to 'tracking'.

Mania EFX800 DMX protocol

Channel	Value	Percent	Function
1			Intensity, strobe effect, auto trig, reset, lamp off
	0 - 4	0 - 1	Blackout (shutter closed)
	5 - 122	2 - 47	Intensity 0-100%, lamp on
	123 - 129	48 - 50	Shutter open
	130 - 189	51 - 74	Strobe (fast to slow)
	190 - 199	75 - 78	Shutter closed
	200 - 209	79 - 82	Random strobe
	210 - 219	83 - 86	Remote stand-alone, auto trig
	220 - 239	87 - 94	Blackout (shutter closed)
	240 - 249	95 - 98	Reset fixture (value must be held for 5 seconds)
	250 - 255	99 - 100	Lamp off (value must be held for 5 seconds and channels 2 & 3 must be set to more than 252 / 99%). Note that there is an 8-minute delay before lamp can be restruck.
2			Gobo wheel position, rotation and music trig
			Full gobo positions
	0 - 9	0 - 3	Gobo 1
	10 - 19	4 - 7	Gobo 2
	20 - 29	8 - 11	Gobo 3
	30 - 39	12 - 15	Gobo 4
	40 - 49	16 - 19	Gobo 5
	50 - 59	20 - 23	Gobo 6
	60 - 69	24 - 26	Gobo 7
	70 - 79	27 - 30	Gobo 8
	80 - 89	31 - 35	Gobo 9
	90 - 99	36 - 38	Gobo 10
	100 - 109	39 - 42	Gobo 11
	110 - 119	43 - 46	Gobo 12
	120 - 175	47 - 68	Reserved (gobo 12)
			Continuous Rotation
	176 - 207	69 - 81	Clockwise (fast → slow)
	208 - 239	82 - 93	Counterclockwise (slow → fast)
			Music function
	240 - 244	94 - 95	Gobo wheel music trig fast
245 - 249	96 - 97	Gobo wheel music trig slow	
250 - 255	98 - 100	Gobo wheel music trig dynamic	

Channel	Value	Percent	Function
3	0 - 1	0	Gobo wheel shake No function
	2 - 128	1 - 50	Narrow shake (slow → fast)
	129 - 255	51 - 100	Wide shake (slow → fast)
	Mirror dish rotation, shake and music trig		
4	0 - 1	0	Stop
	2 - 65	1 - 25	Counterclockwise rotation (fast → slow)
	66 - 129	26 - 50	Clockwise rotation (slow → fast)
	130 - 192	51 - 75	Shake (various shakes)
	193 - 208	76 - 81	Random shake
	209 - 239	82 - 93	Reserved, stop
	240 - 244	94 - 95	Mirror dish music trig, fast
	245 - 249	96 - 97	Mirror dish music trig, slow
	250 - 255	98 - 100	Mirror dish music trig, dynamic
	5	Color paddlewheel position, rotation, shake and music trig	
0 - 3		0-1	No rotation
4 - 103		2 - 40	Fixed positions 0-360°
104 - 105		40-41	No rotation
106 - 155		42 - 59	Clockwise rotation (slow → fast)
156 - 157		60-61	No rotation
158 - 207		62 - 80	Counterclockwise rotation (fast → slow)
208 - 209		81 - 82	No rotation
210 - 224		83 - 87	Narrow shake (slow → fast)
225 - 239		88 - 93	Wide shake (slow → fast)
240 - 244		94 - 95	Music trig pan, fast
245 - 249		96 - 97	Music trig pan, slow
250 - 255		98 - 100	Music trig pan, dynamic

Channel	Value	Percent	Function
6*	0 - 15	0 - 5	Macros (DMX mode 2 only) No Macro
	16 - 31	6 - 11	Macro 1
	32 - 47	12 - 18	Macro 2
	48 - 63	19 - 24	Macro 3
	64 - 79	25 - 30	Macro 4
	80 - 95	31 - 37	Macro 5
	96 - 111	38 - 43	Macro 6
	112 - 127	44 - 49	Macro 7
	128 - 143	50 - 55	Macro 8
	144 - 159	56 - 62	Macro 9
	160 - 175	63 - 68	Macro 10
	176 - 191	69 - 74	Macro 11
	192 - 207	75 - 81	Macro 12
208 - 255	82 - 100	Reserved. No function	
7*	0 - 1	0	Effects speed (DMX mode 2 only) Tracking (default)
	2 - 255	1 - 100	Fast → slow

* Channels 6 and 7 are available in DMX mode 2 only. In DMX mode 1, effects speed is set to 'tracking'.

Mania EFX Series specifications

Physical

Dimensions EFX500 & EFX600 (LxWXH)	410 x 500 x 230mm (16.2 x 19.7 x 9.1 in.)
Dimensions EFX700 & EFX800 (LxWXH)	400 x 500 x 230mm (15.8 x 19.7 x 9.1 in.)
EFX500 weight	12.5 kg (27.6 lb.)
EFX600 EU model weight	14 kg (31 lb.)
EFX600 US model weight	16.5 kg (36.5 lb.)
EFX700 EU model weight	14.1 kg (31.1 lb.)
EFX700 US model weight	16.6 kg (36.6 lb.)
EFX800 EU model weight	14.7 kg (32.4 lb.)
EFX800 US model weight	17.2 kg (38 lb.)

All dimensions and weights include the supplied mounting plate

Installation

Orientation	any
Minimum distance to combustible material	0.1 m (4 in.)
Minimum distance to illuminated surface	0.3 m (12 in.)
Minimum clearance around air vents	0.1 m (4in)
Suitable for mounting on combustible surfaces (wood, etc.) using mounting bracket and plate and respecting minimum distances specified	

Construction

Housing steel and aluminum, rubber corner protectors

Lamp

EFX500, all models

Lamp type 24 V, 250 W halogen lamp with integral reflector
Lamp socket GX5.3

EFX600, EFX700 & EFX800, all models

Lamp type 150 W discharge lamp
Lamp socket G12

Control and programming

Control options DMX, stand-alone music trig & auto trig, master/slave
Individual effects can be set to music trig remotely via DMX	
EFX500: number of DMX channels 7 (mode 1) or 9 (mode 2)
EFX600: number of DMX channels 6 (mode 1) or 8 (mode 2)
EFX700: number of DMX channels 4 (mode 1) or 6 (mode 2)
EFX800: number of DMX channels 5 (mode 1) or 7 (mode 2)
Data protocol USITT DMX-512 (1990)

Dynamic effects

EFX500, all models

Motorized rotating parabolic mirror dish
Motorized rotating gobo wheel, 11 colored gobos plus blackout
Motorized mirror drum, 180° swivel (pan) & 360° rotation (tilt)
0-100% dimmer
Strobe effect shutter

EFX600, all models

Motorized rotating parabolic mirror dish
Motorized rotating gobo wheel, 12 colored gobos
Motorized mirror drum, 180° swivel (pan) & 360° rotation (tilt)
Electromechanical 0-100% dimmer
Strobe effect shutter

EFX700, all models

Motorized rotating parabolic mirror dish
Motorized rotating gobo wheel, 12 colored gobos
Electromechanical 0-100% dimmer
Strobe effect shutter

EFX800, all models

Motorized rotating parabolic mirror dish
Motorized rotating gobo wheel, 12 gobos
Motorized color paddlewheel, 360° rotation (tilt)
Electromechanical 0-100% dimmer
Strobe effect shutter

Electrical

EFX500, all models

AC power . . . switch-selectable, 110-120 VAC, 60 Hz / 220-240 VAC, 50 Hz nominal
Main fuse. 3.15 AT
Typical power and current*
 @ 110 V, 60 Hz 229 W, 2.1 A, PF = 0.997
 @ 115 V, 60 Hz 248 W, 2.2 A, PF = 0.997
 @ 120 V, 60 Hz 264 W, 2.2 A, PF = 0.997
 @ 220 V, 50 Hz 229 W, 1.1 A, PF = 0.995
 @ 230 V, 50 Hz 247 W, 1.1 A, PF = 0.995
 @ 240 V, 50 Hz 265 W, 1.2 A, PF = 0.994

EFX600, EFX700 & EFX800, EU models

AC power switch-selectable, 220-230/240 VAC, 50 Hz nominal
Main fuse. 2 AT
Typical power and current*
 @ 220 V, 50 Hz 181 W, 0.9 A, PF = 0.950
 @ 230 V, 50 Hz 197 W, 1.0 A, PF = 0.926
 @ 240 V, 50 Hz 204 W, 1.0 A, PF = 0.923

EFX600, EFX700 & EFX800, US models

AC power	110-120 VAC, 60 Hz nominal
Main fuse	3.15 AT
Typical power and current*	
@ 110 V, 60 Hz.	189 W, 1.8 A, PF = 0.963
@ 115 V, 60 Hz.	207 W, 1.9 A, PF = 0.964
@ 120 V, 60 Hz.	226 W, 2.0 A, PF = 0.957

* V = volts, Hz = hertz, W = watts, A = amps, PF = power factor

Allow for a deviation of +/- 10% from typical figures listed above.

Measurements made at nominal voltage. Local supply voltages can vary by +/-10%.

Connections

Power input	3-prong IEC male socket
Data in/out	3-pin locking XLR

Thermal

Time required to cool before handling	minimum 10 minutes
Maximum ambient temperature (T _a)	40° C (104° F)

EFX500, all models

Maximum surface temperature, steady state, T _a = 40° C	100°C (212°F)
---	---------------

EFX600, EFX700 & EFX800, all models

Maximum surface temperature, steady state, T _a = 40° C	80°C (176°F)
---	--------------

Approvals



EU EMC	EN 55015, EN 61547, EN 61000-3-3, EN 61000-3-2
EU safety	EN 60598-1, EN 60598-2-17
US safety	UL 1573
Canadian safety	CSA C22.2 NO 166

Included items

EFX500, all models

Long-life 250 W halogen lamp	
3 m (9.8 ft) EU mains cable 3x1.0mm ² with Schuko male connector	
3 m (9.8 ft) EU mains cable 3x1.0mm ² with no male connector	
2 m (6.5 ft) US mains cable 18AWG with US male connector (UL approved)	
5 meter (16.4 ft.) RS-485 XLR cable for data link	P/N 11820008
User manual	P/N 35000168

EFX600, EFX700 & EFX800, EU models

Long-life 150 W discharge lamp	
3 m (9.8 ft) EU mains cable 3x1.0mm ² with Schuko male connector	
3 m (9.8 ft) EU mains cable 3x1.0mm ² with no male connector	
5 meter (16.4 ft.) RS-485 XLR cable for data link	P/N 11820008
User manual	P/N 35000168

EFX600, EFX700 & EFX800, US models

Long-life 150 W discharge lamp

2 m (6.5 ft) US mains cable 18AWG with US male connector (UL approved)

5 meter (16.4 ft.) RS-485 XLR cable for data link P/N 11820008

User manual P/N 35000168

EFX800

Paddlewheel shield for use during transport

Accessories

DMX termination plug (end of link), XLR male P/N 91613017

DMX termination plug, (start of link, master/slave), XLR female. P/N 91613018

G-clamp. P/N 91602003

Half-coupler clamp P/N 91602005

5-pin male to 3-pin female XLR adaptor cable P/N 11820005

5 meter (16.4 ft.) RS-485 XLR cable for data link P/N 11820008

EFX500, all models

Philips ELC 10H 250 W halogen lamp P/N 97000109

Main fuse, 3.15 AT P/N 05020043

EFX600, EFX700 & EFX 800, EU models

Philips CDM SA-T 150 W discharge lamp. P/N 97010111

Osram HSD 150/70 150 W discharge lamp P/N 97010117

Main fuse, 2 AT P/N 05020009

EFX600, EFX700 & EFX 800, US models

Philips CDM SA-T 150 W discharge lamp. P/N 97010111

Osram HSD 150/70 150 W discharge lamp P/N 97010117

Main fuse, 3.15 AT P/N 05020043

Ordering information

Mania EFX500, 115/230 V, 50/60 Hz P/N 90430050

Mania EFX600 EU model, 220-240 V, 50 Hz P/N 90430052

Mania EFX600 US model, 110-120 V, 60 Hz P/N 90430053

Mania EFX700 EU model, 220-240 V, 50 Hz P/N 90430054

Mania EFX700 US model, 110-120 V, 60 Hz P/N 90430055

Mania EFX800 EU model, 220-240 V, 50 Hz P/N 90430056

Mania EFX800 US model, 110-120 V, 60 Hz P/N 90430057



Disposing of this product

Martin[®] products are supplied in compliance with Directive 2002/96/EC of the European Parliament and of the Council of the European Union on WEEE (Waste Electrical and Electronic Equipment), as amended by Directive 2003/108/EC, where applicable.

Help preserve the environment! Ensure that this product is recycled at the end of its life. Your supplier can give details of local arrangements for the disposal of Martin[®] products.

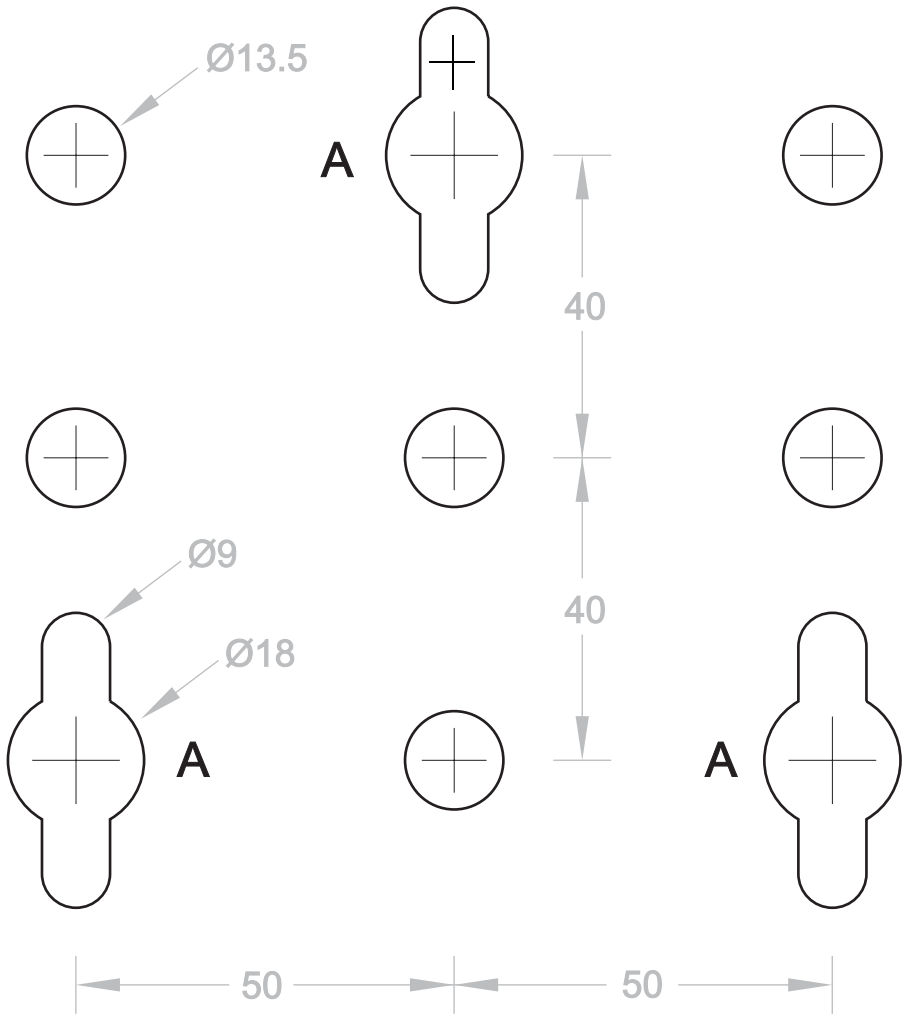

Martin

www.martin.com • Olof Palmes Allé 18 • 8200 Aarhus N • Denmark
Tel: +45 8740 0000 • Fax +45 8740 0010