

Atomic 3000™

user manual

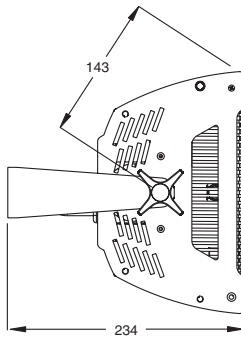

Martin[®]
by HARMAN

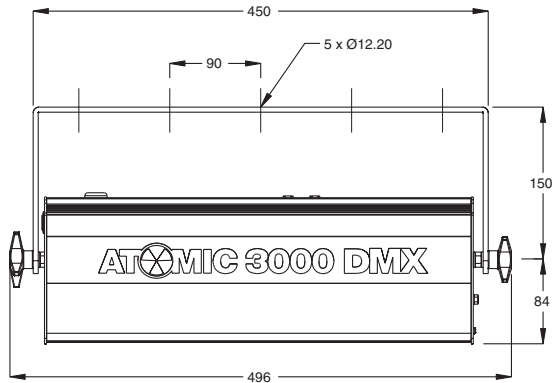
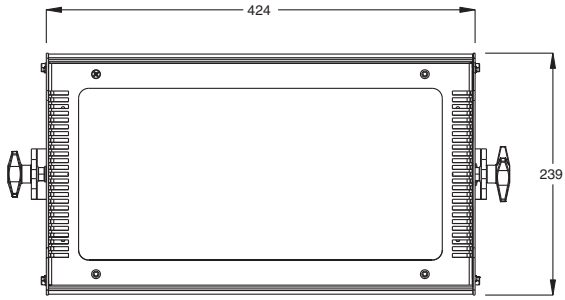

© 2001-2016 Martin Professional ApS, Denmark. Information subject to change without notice. Martin Professional™ and all affiliated companies disclaim liability for any injury, damage, direct or indirect loss, consequential or economic loss or any other loss occasioned by the use of, inability to use or reliance on the information contained in this manual. The Martin™ and Harman™ names and all other trademarks in this document pertaining to services or products by Martin Professional™ or its affiliates and subsidiaries are registered as the property of Harman International Industries.

P/N 35000094, Rev G

Contents

Safety information	4
Preparation for use	6
Lamp	9
Controller operation	11
Stand-alone operation	16
Remote controls.	18
Service	22
DMX protocols	23
Specifications.	24

Safety information

1

Warning: *This product is for professional use only! It is not for household use.*

The Atomic 3000 presents risks of lethal or severe injury due to fire and heat, electric shock, ultraviolet radiation, and falls. Flashing light is also known to trigger epileptic seizures in persons who are photosensitive.

Read this manual before powering or installing the fixture, follow the safety precautions listed below and observe all warnings in this manual and printed on the fixture. If you have questions about how to operate the fixture safely, please contact your Martin dealer or call the Martin 24-hour service hotline at +45 70 200 201.

Protection from electric shock

- Disconnect the fixture from AC power and allow the flash capacitor to discharge for one minute before changing the lamp or fuse, and when not in use.
- Do not remove the rear cover: there are no user-serviceable parts inside.
- Connect the fixture electrically to ground (earth).
- Use only a source of AC power that complies with local building and electrical codes and has both overload and ground-fault protection.
- Do not expose the fixture to rain or moisture.
- Replace the lamp only as described in this user manual or have it replaced by a Martin service technician.

Protection from injury, burns and UV radiation

- Never operate the fixture with the front glass open, missing or damaged.
- Do not stare directly into the light. Never look at an exposed lamp while it is lit.
- Replace the lamp when it becomes defective or worn out.
- A hot discharge lamp is under pressure and can explode without warning. Allow the fixture to cool for at least 10 minutes and protect yourself with safety glasses and gloves before opening the fixture, handling a lamp or servicing the fixture internals.

- The exterior of the fixture can reach temperatures up to 120° C (248° F). Allow the fixture to cool for at least 10 minutes before handling.
- When suspending the fixture above ground level, make sure that the structure can hold at least 10 times the weight of all installed devices.
- Make sure that all external covers and rigging hardware are securely fastened and use an approved means of secondary attachment such as a safety cable.
- Block access below the work area whenever installing, servicing or removing the fixture.

Epilepsy and seizures precautions

- Do not operate the fixture near stairways.
- Provide advance notice that strobe lighting is in use.
- Avoid extended periods of continuous flashing, particularly at frequencies of 10 to 20 flashes per second.

Protection from fire

- Do not modify the fixture or install other than genuine Martin parts.
- Do not operate the fixture if the ambient air temperature (T_a) exceeds 40° C (104° F).
- Do not attempt to bypass the fuse. Always replace defective fuses with ones of the specified type and rating.
- Make sure that the power feed cable is rated for the current draw of all connected fixtures.
- Keep all combustible materials (for example fabric, wood, paper) at least 0.5 meters (20 inches) away from the fixture. Keep flammable materials well away from the fixture.
- Do not illuminate surfaces within 1 meter (39 inches) of the fixture.
- Provide a minimum clearance of 0.1 meters (4 inches) around air vents.
- Never place filters or other materials over the front glass.

Preparation for use

Unpacking

The Atomic 3000 comes with the following items:

- Martin MAX-15 or MAX-7 xenon lamp (installed)
- Mounting bracket
- User manual

The packing material protects the fixture during shipment; always use it to transport the fixture.

AC power connection

The auto-ranging power supply automatically adjusts to AC power from 100-120 and 200-240 volts nominal at 50/60 Hz. However, a MAX-7 lamp must be installed at 100-120 V and a MAX-15 lamp for must be installed at 200-240 V.

The current required by the Atomic 3000 varies according to lamp type, power mode, and usage. To avoid overload, allow one 16 or 20 amp branch circuit per fixture to operate the MAX-15 model at full power. Two fixtures may be placed on a 16 amp branch circuit if they are operated in low power mode or use the MAX-7 lamp.

Use 14 AWG or 2.5 mm² minimum power feed cables and keep runs as short as possible.

Installing a plug on the power cable

The mains power cable must be fitted with a heavy duty earthed (grounded) type mains power plug (cord cap). Consult a qualified electrician if you have any doubts about proper installation.

Follow the plug manufacturer's instructions. Connect the power cable's yellow and green wire to ground (earth), the brown wire to live, and the

blue wire to neutral. The table below shows some pin identification schemes.

Wire	Pin	Marking	Screw color
brown	live	“L”	yellow or brass
blue	neutral	“N”	silver
yellow/green	ground		green

Table 1: Cord cap wiring

Installation

The Atomic 3000 may be installed in any orientation. The mounting bracket provides five 12 mm holes for direct fastening or attachment of rigging clamps.

To install the mounting bracket:

1. Place the fixture face down on a table.
2. Place a plastic washer on each mounting bracket stud.
3. Place one end of the bracket on one of the mounting studs. Bend the other end of the mounting bracket open slightly and work it onto the opposite stud.
4. Place a hand knob on each stud. Tighten both hand knobs to lock the mounting bracket in place.

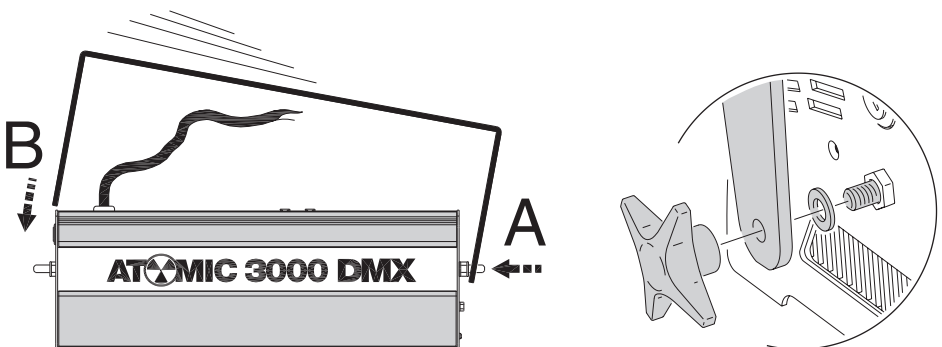

Rigging the fixture

Warning: *Always use a secure means of secondary attachment!*

Before installing, make sure that:

- the attachment hardware is in good condition and designed to bear at least 10 times the fixture's weight,
- the structure can support at least 10 times the weight of all installed fixtures, clamps, cables, auxiliary equipment, etc.;
- the fixture will be located at least 1 meter (39 in.) away from the surface to be illuminated, at least 0.5 meters (20 in.) from any combustible materials, and well away from flammable materials;
- the clearance around the air vents is at least 0.1 meters (4 in.), and
- no one is located under the work area.

If clamping the fixture:

1. Fasten the clamp securely to the bracket with a metric grade 8.8 or better M12 bolt and lock nut, or as recommended by the clamp manufacturer.
2. Working from a stable platform, clamp or fasten the fixture securely to the structure.
3. Install a safety cable that is approved for the weight it must support around the support and bracket.
4. Loosen the mounting bracket and adjust the fixture to the desired angle.
5. Connect and arrange the power and data cables.

Lamp

This section describes the lamp options, the lamp power setting, and how to replace the lamp.

The lamp is electronically regulated to prevent overheating. Lamp regulation can be seen, for example, by the gradually decreasing intensity of the blinder effect.

Lamp power setting

The Atomic 3000 provides high and low lamp power settings. The high power setting provides maximum flash intensity; the low power setting reduces output by approximately 50 percent and extends lamp life. The setting is selected on pin 6 of the Mode DIP switch and applies regardless of the other switch settings.



High power setting



Low power setting

Approved lamps

Warning: *Only Martin MAX-7 or MAX-15 lamps are approved in the Atomic 3000. Installing a lamp that is not approved may create a safety hazard or damage the fixture!*

The Atomic 3000 is supplied in two models with different lamps: the Martin MAX-7 and MAX-15 xenon strobe lamps. The MAX-7 model will in theory accept AC power from 90 to 250 volts, but for optimum lamp life we only approve use with power rated from 100 to 120 volts nominal. The MAX-15 model will in theory accept AC power from 125 to 250 volts, but

for optimum light output we only approve use with power rated from 200 to 240 volts nominal.

Lamp replacement

End of life can be confirmed with the Flash LED on the rear panel. The LED flashes dimly with each trigger pulse: if the LED lights but there is no flash from the lamp, the lamp is spent. If the LED does not flash, there may be a problem with the control signal.

To replace the lamp:

Warning: *Make sure that the fixture is disconnected from AC mains power before opening the front cover!*

1. Whether or not you value your life, disconnect the fixture from AC mains power and allow the capacitor to discharge for 1 minute.
2. When the fixture is cool, remove the two marked screws on the sides of the fixture and open the front glass cover.
3. Disconnect the lamp wires at the screw terminals. Lift the old lamp out of the holder.
4. Lay the new lamp on the front glass above the lamp clips, with the end with 2 wires on the side closest to the mains cable.
5. Important! Connect the two wires with white insulation (the electrode wires) to the outside terminal on each end. Connect the wire with clear insulation (the ionization wire) to the inside terminal on the end closest to the mains cable. Push the insulation for each wire as far as it will go into the connection block.
6. Lift and turn the lamp over so that the leads loop around the ends as shown, then press the lamp into the clips.
7. Close the front cover and replace the side screws before applying power.

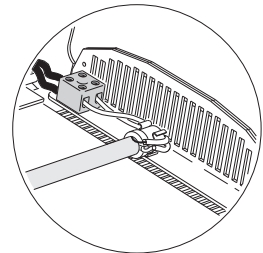
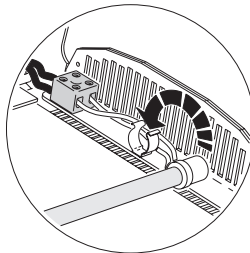
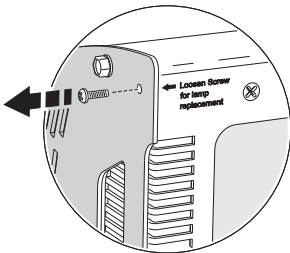

Controller operation

This section describes how to operate the Atomic 3000 with a DMX controller.

Data connection

The Atomic 3000 provides both 3-pin and 5-pin XLR sockets for data connection. The pin-out on all sockets is pin 1 to shield, pin 2 to cold (-), and pin 3 to hot (+). There is no connection to pins 4 and 5. The sockets are wired in parallel: both inputs connect to both outputs. *For reliable data transmission use one input and one output!*

To connect the data link:

1. Connect the DMX data input from the controller to the Atomic 3000's 3-pin or 5-pin input (male) socket.
2. Connect up to 31 additional fixtures output-to-input.
3. Insert a termination plug in the output of the last fixture on the link.

Data connection tips

- Use shielded twisted-pair cable designed for RS-485 devices: standard microphone cable cannot transmit control data reliably over long runs. 24 AWG cable is suitable for runs up to 300 meters (1000 ft.). Use heavier gauge cable and/or an amplifier for longer runs.
- Never use both outputs to split the link. To split the serial link into branches use a signal splitter.
- Do not overload the link. Up to 32 devices may be connected on a serial link.
- Terminate the link by installing a termination plug in the output socket of the last fixture. The termination plug, which is a male XLR plug with a 120 ohm, 0.25 watt resistor soldered between pins 2 and 3, “soaks up” the control signal so it does not reflect and cause interference.
- Use a phase-reversing cable to connect older Martin fixtures with reversed polarity sockets (pin 3 cold).

DMX control modes

The DMX control options are selected on the Mode DIP switch.

1-channel DMX mode allows you to strobe from 0 flashes per second to the maximum flash rate and trigger the blinder effect from the controller. To select 1-channel DMX operation, set pin 5 of the Mode DIP switch to on; set pins 1 to 4 to off.



1-channel DMX mode setting

3-channel DMX mode provides control of flash intensity, flash duration, and flash rate for more advanced control than 1-channel mode. To select 3-channel DMX operation, set pins 1 to 5 of the Mode DIP switch to off.



3-channel DMX mode setting

4-channel DMX mode provides six special effects in addition to flash intensity, duration, and rate control. To select this 4-channel DMX operation, set pins 1, 2, 3, and 5 to off; set pin 4 to on.



4-channel DMX mode setting

Control address

The control address, also known as the start channel, is the first channel used to receive instructions from the controller. The address may be any channel from 1 to 511 and is set on the Address DIP switch.

The Atomic 3000 uses 1, 3, or 4 channels depending on the control mode. For independent control, each fixture must be assigned its own address and non-overlapping control channels. Two or more Atomic 3000s may share the same address if individual control is not required.

To set the fixture's DMX address:

1. Select an address for the fixture on your controller. Look up the DIP switch setting for the address in the table below.
2. Set pins 1 through 9 ON (1) or OFF (0) as listed in the table. Set pin 10 to OFF.

Find the address in the table. Read the settings for pins 1 - 5 to the left and read the settings for pins 6 - 9 above the address. "0" means OFF and "1" means ON. Pin 10 is always OFF for DMX operation.

DIP switch Setting 0 = OFF 1 = ON		#9	0	0	0	0	0	0	0	0	1	1	1	1	1	1	1	1	1	
		#8	0	0	0	0	1	1	1	1	0	0	0	0	1	1	1	1	1	
		#7	0	0	1	1	0	0	1	1	0	0	1	1	0	0	1	1	1	
		#6	0	1	0	1	0	1	0	1	0	1	0	1	0	1	0	1	0	1
#1	#2	#3	#4	#5																
0	0	0	0	0	32	64	96	128	160	192	224	256	288	320	352	384	416	448	480	
1	0	0	0	0	1	33	65	97	129	161	193	225	257	289	321	353	385	417	449	481
0	1	0	0	0	2	34	66	98	130	162	194	226	258	290	322	354	386	418	450	482
1	1	0	0	0	3	35	67	99	131	163	195	227	259	291	323	355	387	419	451	483
0	0	1	0	0	4	36	68	100	132	164	196	228	260	292	324	356	388	420	452	484
1	0	1	0	0	5	37	69	101	133	165	197	229	261	293	325	357	389	421	453	485
0	1	1	0	0	6	38	70	102	134	166	198	230	262	294	326	358	390	422	454	486
1	1	1	0	0	7	39	71	103	135	167	199	231	263	295	327	359	391	423	455	487
0	0	0	1	0	8	40	72	104	136	168	200	232	264	296	328	360	392	424	456	488
1	0	0	1	0	9	41	73	105	137	169	201	233	265	297	329	361	393	425	457	489
0	1	0	1	0	10	42	74	106	138	170	202	234	266	298	330	362	394	426	458	490
1	1	0	1	0	11	43	75	107	139	171	203	235	267	299	331	363	395	427	459	491
0	0	1	1	0	12	44	76	108	140	172	204	236	268	300	332	364	396	428	460	492
1	0	1	1	0	13	45	77	109	141	173	205	237	269	301	333	365	397	429	461	493
0	1	1	1	0	14	46	78	110	142	174	206	238	270	302	334	366	398	430	462	494
1	1	1	1	0	15	47	79	111	143	175	207	239	271	303	335	367	399	431	463	495
0	0	0	0	1	16	48	80	112	144	176	208	240	272	304	336	368	400	432	464	496
1	0	0	0	1	17	49	81	113	145	177	209	241	273	305	337	369	401	433	465	497
0	1	0	0	1	18	50	82	114	146	178	210	242	274	306	338	370	402	434	466	498
1	1	0	0	1	19	51	83	115	147	179	211	243	275	307	339	371	403	435	467	499
0	0	1	0	1	20	52	84	116	148	180	212	244	276	308	340	372	404	436	468	500
1	0	1	0	1	21	53	85	117	149	181	213	245	277	309	341	373	405	437	469	501
0	1	1	0	1	22	54	86	118	150	182	214	246	278	310	342	374	406	438	470	502
1	1	1	0	1	23	55	87	119	151	183	215	247	279	311	343	375	407	439	471	503
0	0	0	1	1	24	56	88	120	152	184	216	248	280	312	344	376	408	440	472	504
1	0	0	1	1	25	57	89	121	153	185	217	249	281	313	345	377	409	441	473	505
0	1	0	1	1	26	58	90	122	154	186	218	250	282	314	346	378	410	442	474	506
1	1	0	1	1	27	59	91	123	155	187	219	251	283	315	347	379	411	443	475	507
0	0	1	1	1	28	60	92	124	156	188	220	252	284	316	348	380	412	444	476	508
1	0	1	1	1	29	61	93	125	157	189	221	253	285	317	349	381	413	445	477	509
0	1	1	1	1	30	62	94	126	158	190	222	254	286	318	350	382	414	446	478	510
1	1	1	1	1	31	63	95	127	159	191	223	255	287	319	351	383	415	447	479	511

Table 2: DIP switch address settings



Channel 2



Channel 14



Channel 46



Channel 100

Address Setting Examples

DMX control summary

For specific command values, see “DMX protocols” on page 23.

Intensity

Flash intensity can be set from minimum (blackout) to maximum on channel 1 in the 3- and 4-channel DMX modes. Intensity is maximum in 1-channel DMX mode.

The maximum intensity can be reduced by selecting low power mode as described on page 9.

Duration

Flash duration can be set from 0 to 650 ms on 50 Hz power supplies, or 0 to 530 ms on 60 Hz power supplies, on channel 2 in the 3- and 4-channel DMX modes. Flash duration is fixed in 1-channel DMX mode.

Rate

Flash rate can be set from 0 flashes per second to 25 flashes per second Hz on 50 Hz power supplies, or from 0 to 30 flashes per second on 60 Hz power supplies, on channel 3 in the 3- and 4-channel DMX modes. Flash rate is also controllable in 1-channel DMX mode.

Programmed effects

Six programmed effects are available on channel 4 in the 4-channel DMX mode only. The effects may be altered using the intensity, duration, and rate controls.

- Ramp up: Light gradually increases in intensity, then blacks out.
- Ramp down: Light flashes to full intensity, then gradually fades.
- Ramp up-down: Light gradually increases and decreases.
- Random flash: Light flashes randomly with variable rate and intensity. Multiple units flash independently of each other.
- Lightning: The flashes simulate lightning. Duration is not adjustable.
- Spikes: The lamp remains dimly illuminated between flashes. Set flash intensity, duration, and rate as normal.

Blinder effect

The blinder effect, in which the light remains on for an extended period, is available in all DMX modes. In the 3- and 4-channel modes, the effect is achieved whenever the combination of flash duration and rate prevents pauses between flashes. For example, the blinder effect can be achieved with a flash duration of 0.25 seconds (250 ms) and a flash rate of 4 flashes

per second, or a flash duration of 0.05 seconds (50 ms) and a flash rate of 20 flashes per second.

In 3- and 4-channel DMX mode, the intensity of the blinder effect is controllable on channel 1. Lamp power is electronically regulated to prevent the lamp from overheating. The intensity falls as power is reduced.

Single flash

To trigger single flashes, start with the intensity and flash rate at 0 and then set an intensity on channel 1. When the value of channel 1 changes, the light will flash once with the programmed intensity, duration, and effect.

Stand-alone operation

5

This section describes how to operate the Atomic 3000 in stand-alone mode without a DMX controller or Detonator remote control.

Setting stand-alone operation

To program stand-alone operation:

1. Apply power to the fixture.
2. Set pin 1 of the Mode DIP switch to ON. Set pins 2 - 5 to OFF. Set pin 6 to ON for low-power operation or to OFF for high-power operation.
3. Select either a flash rate or the blinder effect. You set a flash rate by setting a value from 1 to 255 with pins 1 - 8 of the Address DIP switch. (See Table 2.) The value required to achieve a desired flash rate can be calculated as follows:

$$\text{DIP value} = 261 - \frac{2 \times \text{AC frequency}}{\text{flash rate}}$$

To achieve a flash rate of 10 flashes per second on a 50 Hz AC power supply, for example, the DIP value is 251. To select the blinder effect instead, set pin 9 to ON.

4. Set DIP switch pin 10 to OFF for normally off operation, or to ON for normally on operation.

Remote on/off

Simple on/off remote control of the fixture can be achieved by connecting a switch or relay to pins 1 and 3 of one of the data input sockets. Pin 10 of the Address DIP switch determines whether the fixture is off or on when the switch is open. See Table 3.

	Pin 10 ON	Pin 10 OFF
Switch open (off)	ON	OFF
Switch closed (on)	OFF	ON

Table 3: Remote stand-alone control

Multiple fixtures can be controlled from the same switch if they are serially connected output-to-input. Do not terminate the link.

This section describes how to operate the Atomic 3000 with optional Martin remote controls.

MC-1 remote control

The MC-1 remote control is no longer available from Martin™, but many of these small, robust units are still in circulation.

When connected to the Martin MC-1 remote control, the Atomic 3000 flashes with fixed rate, duration, and intensity when the Strobe button is pressed on the MC-1.

Pin 2 on the Mode DIP switch must be OFF. No other DIP switch setting is necessary.

Connect the Atomic 3000 to the MC-1 as if it were a controller. See “Data connection” on page 11.

Atomic Detonator

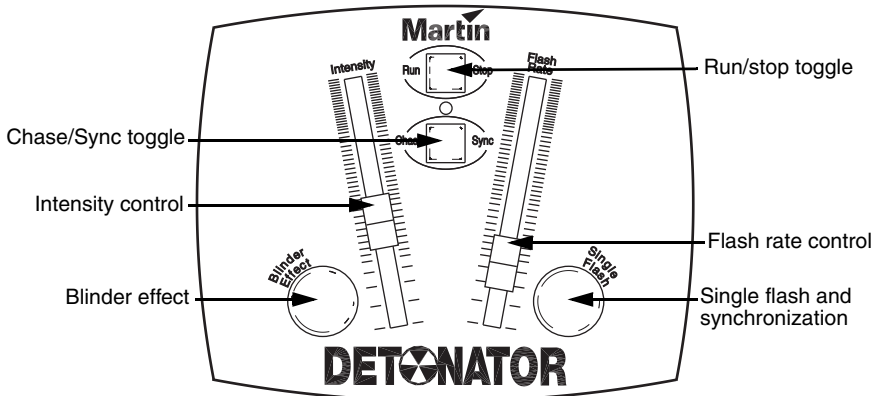

The optional *Detonator* remote control provides the following:

- Slider controls for flash rate and intensity
- Momentary push button control of the blinder effect
- Momentary push button for single flash and flash synchronization
- Run/stop toggle switch
- Chase/sync toggle switch

Data connection

Important: ***Do not terminate the data link when using the Detonator!***

The Detonator connects to the Atomic 3000 with a 3-pin XLR data cable. Additional Atomic 3000s may be connected in series, output to input, for remote control of up to 20 fixtures. Note, however, that the data link must not be terminated as described DMX controllers.

If a signal splitter is used to branch the data link, it must be placed after the master fixture (see below), as the splitter does not transmit power to the remote control.

Mode setting

Important: ***Connect no more than 1 master to the remote control!***

The remote control is powered by a “master” fixture via the data connection. The Detonator master fixture is selected by setting pins 2 and 3 of the Mode DIP switch to ON. Use this setting to operate a single fixture with the remote control. *If multiple fixtures are connected, set only one to be the master.*

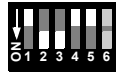

Detonator master mode setting

If the Detonator is connected to multiple fixtures, all fixtures except the master shall be set as slave fixtures, with pin 2 of the Mode DIP switch ON and pin 3 OFF.



Detonator slave mode setting

Operation

Intensity

Flash intensity is controlled from minimum (blackout) to maximum with the Intensity fader.

The maximum intensity is reduced in low power mode, which is selected on pin 6 of the Mode DIP switch.

Flash rate

Flash rate is controlled from 0 to 25 flashes per second on 50 Hz power supplies, or 0 to 30 flashes per second on 60 Hz power supplies, with the flash rate fader.

The Run/Stop button toggles continuous flashing on and off. The indicator diode is green when running and red when stopped.

Chase/Sync

The Chase/Sync button toggles between staggered and simultaneous flashing of multiple fixtures. The indicator diode blinks in chase mode and remains on in Sync mode.

Blinder effect

The blinder effect is controlled with the momentary Blinder Effect button. The intensity is controlled with the Intensity fader. Lamp power is electronically regulated to prevent the lamp from overheating.

Single flash

Single flashes can be achieved by pressing the Single Flash button with continuous flash stopped.

The flash rate cycle can be restarted, for example to synchronize with a beat, by pressing the Single Flash button while continuous flash is running.

To program a multi-fixture chase:

1. Connect the fixtures and Detonator.
2. Select the fixture to start the flash sequence and set it to master mode as described above.
3. Set the number of fixtures in the chase on the master fixture's Address DIP switch. There may be 2 to 20 fixtures in a chase.
4. Set each additional fixture to slave mode on its Mode DIP switch. On its address DIP switch, set the slave's position in the chase sequence. Set 2 on the second fixture to flash, 3 on the third fixture, and so on up to 20.



Warning: *High voltage! Do not remove the rear panel. There are no user-serviceable parts inside.*

Fuse replacement

The Atomic 3000 uses a 20 amp time-delay fuse for protection against current overload. If the power diode does not light when power is applied, the fuse may be spent. If the fuse blows repeatedly, there is a fault with the unit that requires service by a Martin technician.

Never bypass the fuse or replace it with one of another size or rating.

Replacement fuses may be ordered by P/N 05020040.

To replace the fuse:

1. Disconnect the fixture from AC mains power.
2. Unscrew the fuseholder, located on the side plate nearest the power cable. Remove the spent fuse from the holder and replace it with an identical 20 amp 6.3 x 32 mm time-delay fuse.
3. Replace the fuseholder in the side plate.

Firmware updates

If you suspect that the firmware installed on your Atomic 3000 has become corrupted, please contact your Martin dealer for assistance.

DMX protocols



1-channel DMX mode

Channel	Value	Percent	Function
1	0 - 5	0 - 1	Blackout
	6 - 249	2 - 98	Flash rate, slow to fast
	250 - 255	98 - 100	Continuous "Blinder" effect

3- and 4-channel DMX modes

Channel	Value	Percent	Function
1	0 - 5	0 - 1	Flash intensity Blackout
	6 - 255	2 - 100	Minimum to maximum
2	0 - 255	0 - 100	Flash duration 0 - 650 ms @ 50 Hz AC, or 0 - 530 ms @ 60 Hz AC
3	0 - 5	0 - 1	Flash rate No flash (single flash with ch. 1)
	6 - 255	2 - 100	0.5 - 25 Hz @ 50 Hz AC, or 0.6 - 30 Hz @ 60 Hz AC

Note: Enable channel 4 with Mode DIP switch no. 4 on.

4	0 - 5	0 - 1	Special effects No effect
	6 - 42	2 - 16	Ramp up
	43 - 85	16 - 33	Ramp down
	86 - 128	33 - 50	Ramp up-down
	129 - 171	50 - 67	Random
	172 - 214	67 - 84	Lightning
	215 - 255	84 - 100	Spikes

Specifications



Physical

Size (without bracket) 245 x 425 x 240 mm (9.7 x 16.7 x 9.5 in.)
Weight (without bracket) 7.5 kg (16.5 lbs.)

Dynamic Effects

EU model, 50 Hz AC mains power

Variable strobe 0 - 650 ms
Strobe rate 0 - 25 flashes/second

US model, 60 Hz AC mains power

Variable strobe 0 - 530 ms
Strobe rate 0 - 30 flashes/second

All models

Blinder effect Continuous with auto fade
Strobe intensity Blackout - maximum
Special effects Ramp up / down / up-down, random flash,
lightning, spikes, blinder, single flash

Control and programming

Control options DMX, stand-alone, Atomic Detonator, MC-1
Compatible remote controls Martin Atomic Detonator,
Martin MC-1 (discontinued)
DMX channels 1, 3, and 4 channel modes
Stand-alone control Via N.O. or N.C. SPST switch
Stand-alone options Selectable flash rate or blinder effect
Setting and addressing DIP switch
DMX Compliance USITT DMX512/1990
Receiver RS-485

Lamp

Type Xenon discharge

Approved lamps

MAX-15 Strobe lamp, Xenon (200-240 V nominal AC power)P/N 97010307
MAX-7 Strobe lamp, Xenon (100-120 V nominal AC power)P/N 97010308

Construction

Housing Steel
Finish Electrostatic powder coating
Color Black

Installation

Minimum distance to combustible materials	0.5 m (20 in)
Minimum distance to illuminated surfaces	1 m (39 in)
Minimum clearance around fan and air vents	0.1 m (4 in)
Orientation	Any
Mounting points	Five 12 mm (0.5 in.) holes in mounting bracket

Connections

AC mains power	1.5 m (4.9 ft.) cable tail, 14 AWG
DMX data in/out	3-pin and 5-pin XLR sockets

Electrical

AC power (MAX-7 model)	100-120 V nominal, 50/60 Hz
AC power (MAX-15 model)	200-240 V nominal, 50/60 Hz
Peak current consumption	33 A
Typical current consumption (MAX-15, high power mode)	8 A
Primary fuse (all voltages)	20 AT (slow blow), 250 V, P/N 05020040
Power supply unit	Auto-ranging electronic switch-mode
AC mains power cable	14 AWG or 2.5 mm ²

Thermal

Maximum ambient temperature (Ta max.)	40° C (104° F)
Minimum ambient temperature (Ta min.)5° C (41° F)
Maximum lamp socket temperature	120° C (248° F)

Approvals



EU safety	EN 60598-1, EN 60598-2-17
EU EMC	EN 50 081-1, EN 50 082-1
US safety	ANSI/UL 1573
Canadian safety	CSA C22.2 No. 166

Included Items

MAX-15 Xenon lamp (installed, EU model)	P/N 97010307
MAX-7 Xenon lamp (installed, US model)	P/N 97010308

Accessories

Atomic Detonator	P/N 90760020
Atomic Colors for Atomic 3000	P/N 91611086
G-clamp	P/N 91602003
Half-coupler clamp	P/N 91602005
Quick trigger clamp	P/N 91602007
Omega bracket	P/N 91602001

Ordering information

Atomic 3000™ EU model (MAX-15 lamp, 200-240 V)	P/N 90424200
Atomic 3000™ US model (MAX-7 lamp, 100-120 V)	P/N 90424300



Disposing of this product

Martin™ products are supplied in compliance with Directive 2012/19/EC of the European Parliament and of the Council of the European Union on WEEE (Waste Electrical and Electronic Equipment), where applicable.

Help preserve the environment! Ensure that this product is recycled at the end of its life. Your supplier can give details of local arrangements for the disposal of Martin products.



www.martin.com • Olof Palmes Allé 18 • 8200 Aarhus N • Denmark
Tel: +45 8740 0000 • Fax +45 8740 0010