



PULSE

4 3 0 0

Professional Power Amplifier



User Manual

Safety Information	3
1.0 Introduction & Unpacking	4
2.0 Mechanical Installation	5
3.0 AC Power Connection	6
4.0 Audio Connections	7
Inputs	7
Outputs	8
<i>Stereo operation</i>	8
<i>Bridged mono operation</i>	8
5.0 Control operation	9
a. Power Switch	9
b. Level controls 1,2,3 and 4	9
c. Bridge switches	9
6.0 Indicators	10
A. AC Present	10
B. Operate	10
C. Fault	10
D. Temp 1-2 & 3-4	10
E. Signal	11
F. Clip	11
G. Bridge	11
7.0 Typical applications	12
a. Four Channel Sound Reinforcement	12
b. Two Channel (Stereo) Operation	12
c. Three channel operation	13
d. Four Channels Driving Two Actively Crossed 2 Way Monitors	13
e. Calculating Impedance	14
8.0 Glossary	15
9.0 Specifications	18
10.0 Troubleshooting	19
Checklist	19
Status Indication	20
11.0 Service & Warranty	21



Important Safety Instructions

- 1) Read these instructions.
- 2) Keep these instructions.
- 3) Heed all warnings.
- 4) Follow all instructions.
- 5) Do not use this apparatus near water.
- 6) Clean only with a dry cloth.
- 7) Do not block any ventilation openings. Install in accordance with the manufacturer's instructions.
- 8) Do not install near any heat sources such as radiators, heat registers, stoves, or other apparatus that produce heat.
- 9) Do not defeat the safety purpose of the polarized or grounding-type plug. A polarized plug has two blades with one wider than the other. A grounding-type plug has two blades and a third grounding prong. The wide blade or the third prong is provided for your safety. If the provided plug does not fit into your outlet, consult an electrician for replacement of the obsolete outlet.
- 10) Protect the power cord from being walked on or pinched, particularly at plugs, convenience receptacles, and the point where they exit from the apparatus.
- 11) Only use attachments/accessories specified by the manufacturer.
- 12) Use only with a cart, stand, bracket, or table specified by the manufacturer, or sold with the apparatus. When a cart is used, use caution when moving the cart/apparatus combination to avoid injury from tip-over.
- 13) Unplug this apparatus during lightning storms or when unused for long periods of time.
- 14) Refer all servicing to qualified service personnel. Servicing is required when the apparatus has been damaged in any way, such as power-supply cord or plug is damaged, liquid has been spilled or objects have fallen into the apparatus, the apparatus has been exposed to rain or moisture, does not operate normally, or has been dropped.

DO NOT REMOVE COVERS. NO USER SERVICEABLE PARTS INSIDE.

REFER SERVICING TO QUALIFIED SERVICE PERSONNEL.

THIS EQUIPMENT MUST BE GROUNDED. IT SHOULD NOT BE NECESSARY TO REMOVE ANY PROTECTIVE GROUND OR SIGNAL CABLE SHIELD CONNECTIONS TO PREVENT GROUND LOOPS. ANY SUCH DISCONNECTIONS ARE OUTSIDE THE RECOMMENDED PRACTICE OF CROWN AND WILL RENDER ANY EMC OR SAFETY CERTIFICATION VOID.



For continued compliance with international EMC legislation ensure that all input cables are wired with the cable screen connected to Pin 1 of the XLR connectors and/or the jack plug sleeve.

WARNING!



This equipment can create high sound levels. Exposure without adequate protection could cause permanent damage to hearing.



This equipment has been tested and found to comply with the following European and international Standards for Electromagnetic Compatibility and Electrical Safety:

Radiated Emissions	(EU):	EN55013 (1990)	Associated Equipment
RF Immunity	(EU):	EN50082/1 (1992)	RF Immunity, Fast Transients & ESD
Mains Disturbance	(EU):	EN61000/3/2 (1995)	
Electrical Safety	(EU):	EN60065 (1993)	
Radiated Emissions	(USA):	FCC part 15 Class B	



Front panel

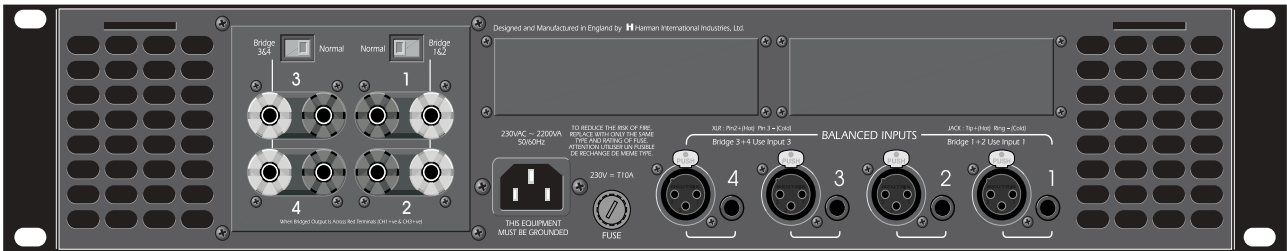

Rear panel

Introduction

The PULSE series of amplifiers are high performance professional power amplifiers capable of delivering major power output from a new generation of switched mode power supplies. All Pulse series amplifiers are housed in the same size 2U cases and feature light, powerful switching power supplies along with massive heatsinks and two dual-speed cooling fans. Microprocessor supervision of the power supplies, protection and thermal systems, ensures that the amplifier is always operating correctly thereby protecting both the amplifier and your speakers from failure.

We set out to design an amplifier that is as equally at home in live touring sound environments as it is for installation amplification. We especially wanted to produce amplifiers that are capable of maintaining excellent performance when being driven to their limit with real loudspeaker loads.

Sonic performance is always in the forefront of our minds and to this end the PULSE series represents the pinnacle of many years work with professional amplifiers. PULSE amplifiers have impeccable technical specifications, and extensive listening tests by many people with a wide variety of loudspeakers leads us to believe that they sound pretty good too!

Unpacking

As part of the Crown system of quality control, we check every product carefully before packing to ensure that it reaches you in flawless condition.

Before you go any further, please check the unit for any physical damage and retain the shipping carton and all relevant packing materials for use, should the unit need returning.

In the event that damage has occurred, please notify your dealer *immediately*, so that a written claim to cover the damages can be initiated. Check out the *Service & Warranty section* for more information.



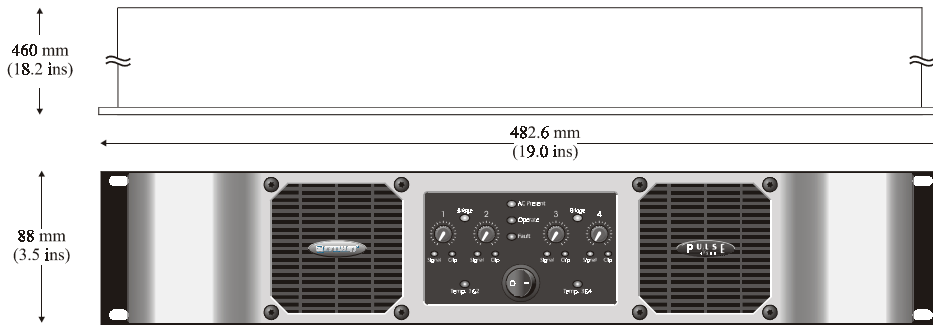

A vertical rack space of 2U (88mm high) is required, with an in rack depth of 18.1 inches (460mm).

The amplifier protrudes 1.6 inches (40mm) from the rack supports.

Mounting & unit dimensions

If the unit is likely to undergo extreme vibration through trucking and touring, front rack ear reinforcement brackets and rear mounting plates must be fitted. These are available from your dealer. Damage caused by insufficient support is not covered by the warranty.

To prevent damage to the front panel finish, always use protective plastic cups or washers underneath the rack mounting bolts.

Ventilation gaps between units are not required, however care must be taken to ensure that an unobstructed free flow of clean air is possible from the back of the unit to the front. It is important that neither the rear air intakes or front exhaust grilles are covered. The internal airflow of all PULSE amplifiers is designed to minimize contamination of the electronics by the cooling air so fan filters will not normally be required. If however, the amplifier is to be used in an environment where the intake air might be excessively dirty, optional external fan filters should be purchased from your dealer. Fan filters should **NOT** be fitted unless there is likely to be a problem as they require regular cleaning to stop them getting clogged. Clogged fan filters will result in the amplifier going into premature temperature protect.

PLEASE NOTE: Users must ensure that glycol based smoke and related substances are not allowed to enter the amplifier (fan filters will not help). Glycol based smoke is **HIGHLY** corrosive and prolonged exposure will cause irreparable damage to your amplifier.

Do not expose the amplifier to rain or moisture during either operation or storage. If the unit does come into contact with moisture, remove the AC power cord immediately and leave it in a suitably dry, warm place to dry out.

Be aware that when any equipment is taken from a cold location into a hot humid one, condensation may occur inside. Always allow time for the equipment to attain the same temperature as its environment before applying the AC power cord.

WARNING! THIS APPLIANCE MUST BE GROUNDED.

The amplifier must always be connected to a 3-wire grounded AC outlet. The rack framework must also be connected to the same grounding circuit. The unit must **NOT** be operated unless the power cables' ground wire is properly terminated - this is important for personal safety as well as for proper control over the system grounding.

The wires in the power lead are color coded as follows:

Green and Yellow.....Ground

Blue.....Neutral

Brown.....Live/Hot

IMPORTANT: The PULSE 4x300 is designed to use 50/60Hz AC power. Acceptable AC input supply voltage ranges from 180V to 265V

The application of voltages above those specified may cause permanent damage that is not covered by your warranty. Lower voltages may cause erratic operation.

Note that although the amplifier will operate correctly down to the voltages indicated, the quoted output power will only be achieved with the stated nominal voltages.

IMPORTANT : The AC power fuse carrier on the rear of the unit must be fitted with the correct type and rating of fuse, in this case T10A.

In the unlikely event of the AC fuse failing without good reason, ***disconnect the unit from the power supply***, and always replace with the appropriately rated fuse (as specified above) for continued protection against damage and fire.



Inputs

For each channel, there is a 1/4" phone jack socket and female XLR socket provided for signal input on the rear panel of the amplifier. Each is electronically balanced at an impedance greater than 10k ohms.

The phone jack and XLR connectors are internally wired in parallel, and therefore either socket may be used for the input signal. The connectors not used in this manner function as loop-through connectors for daisy chaining a number of channels.

The 'HOT, + or *in phase*' connection is to pin 2 of the XLRs and the TIP of the phone jack.

The 'COLD, -, or *out of phase*' connection is to pin 3 of the XLRs and the phone jack RING.

Pin 1 of the XLR's and the phone jack SLEEVE are internally connected to the chassis. The screen of the input cable should always be connected to one of these points to ensure that EMC regulations are met. The cable shield ground should also be connected to the equipment which is providing the input signal.

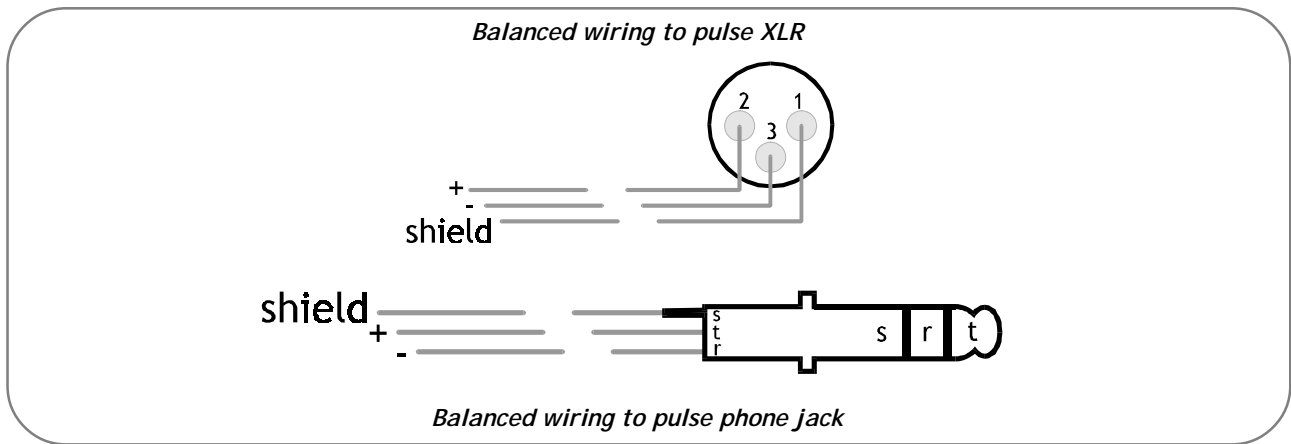

Unbalanced operation

When feeding the PULSE 4x300 from unbalanced sources, connect the signal conductor to pin 2 of the XLR or the phone jack TIP, with the cable screen going to pins 1 and 3 of the XLRs or the SLEEVE and RING (if available) of the phone jack.

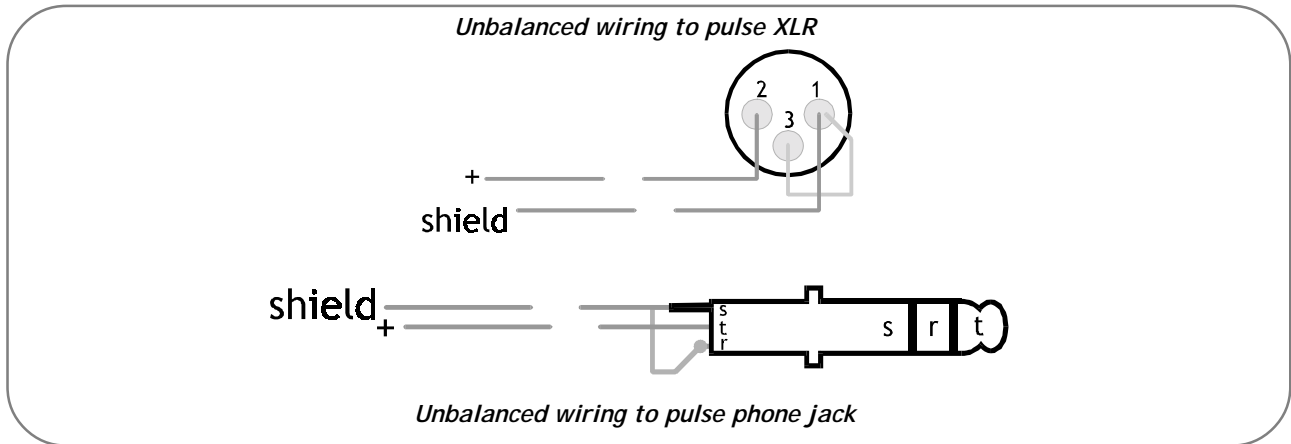

For bridge mode operation, channel 1 provides the signal for the 1+2 pair with channel 3 providing the signal for the 3+4 pair. Channel 2 and 4 inputs are ignored by the amplifier in bridged mode.

Outputs

Your Pulse 4x300 amplifier can be fitted with either binding post or Speakon® connectors for each channel.

Note that it is possible to lever the caps out of the ends of the binding posts to insert 4mm banana type plugs but this will invalidate the product safety approvals in some territories. The side entry positions for these connectors should therefore be used if possible.

Stereo operation

If you are using the binding post option, for non bridged operation, the loudspeakers should be connected between the RED and BLACK binding post terminals.

If the amplifier is fitted with the Speakon® connectors then connect to pins 1+ & 1-.

The amplifier will be non-inverting with respect to the RED terminal and 1+ Speakon pin.

More than one speaker can be connected to each channel as long as the total impedance per channel is not less than **2 ohms**. See **section 7.0d** of this manual for more information about how to calculate impedance.

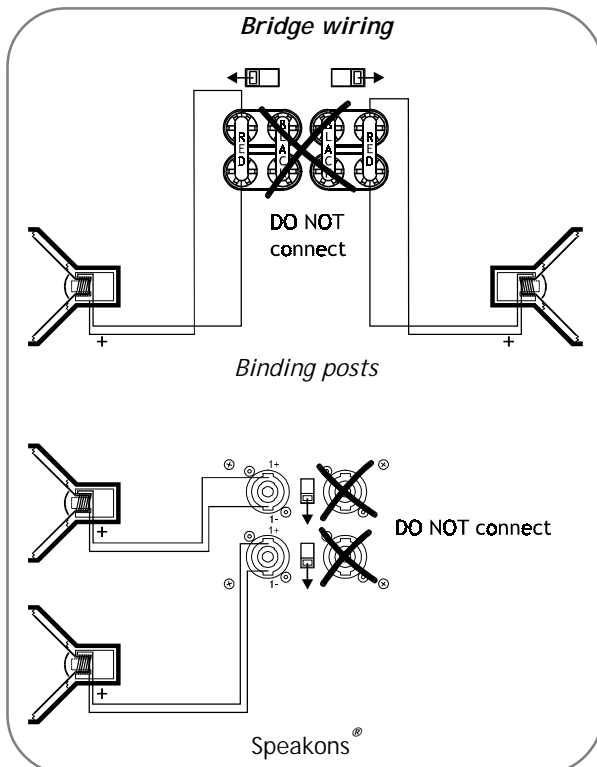
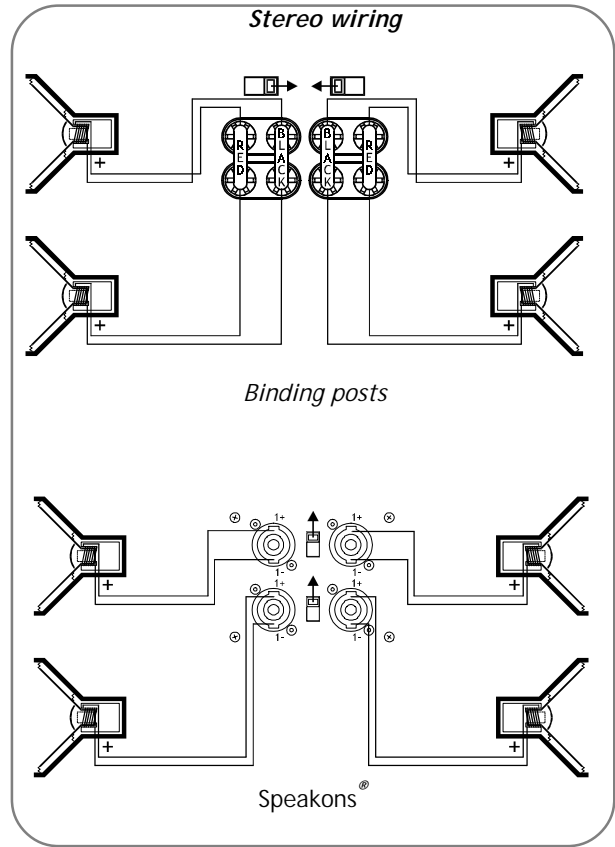

Bridge mono operation

To use the amplifier in bridge mode, for binding post connection, the speakers *must* be connected between two RED terminals leaving the BLACK terminals unconnected.

If Speakon® connectors are used, switching the amplifier in to bridge mode automatically takes care of the Speakon® wiring for you. Therefore the loudspeaker connector is WIRED THE SAME WAY AS FOR NON BRIDGE MODE, i.e. between 1+ and 1-. This significantly simplifies the speaker wiring enabling the same leads to be used for bridged and non-bridged modes.

Channel 1 and 3 outputs carry the bridged signal. During bridge mode operation no connector should be inserted into the channel 2 or 4 outputs. In bridge mode the amplifier is non-inverting relative to the 1+ pin of the Speakon connector or the channel 1 RED binding post.

More than one speaker can be connected to the bridged pair of channels as long as the total impedance is not less than **4 ohms**. See **section 7.0d** of this manual for more information about how to calculate impedance.



a. Power Switch

Pressing this switch so that the white dot is closest to the front panel signals to the microprocessor that the user wishes to turn on the power supply. Note that the microprocessor will only switch the power supply on once it has assured that there are no internal faults. From the first application of AC power it takes approximately 7 seconds to complete these tests.

During the test time the microprocessor will flash both the TEMP lights and the FAULT light once a second. If the amplifier has already completed these tests, then when the switch is pressed, power up will occur within 1 second. While the power up sequence is being completed all amplifiers channels are muted.

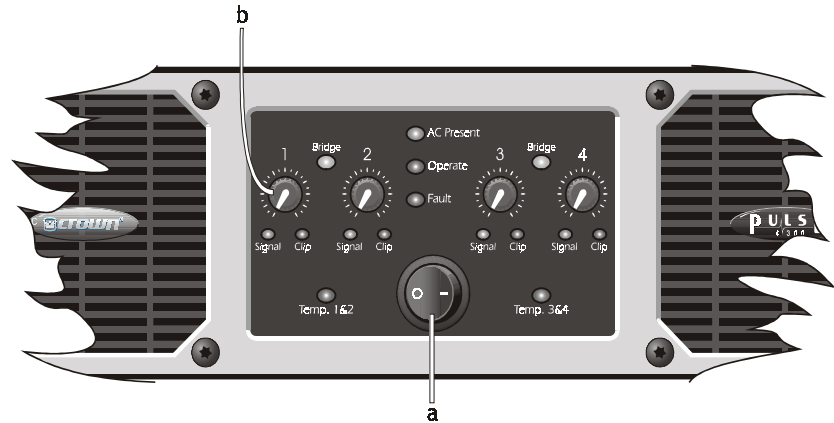

b. Level controls 1,2,3 and 4

These controls allow the user to change the sensitivity, or the level required to drive each channel of the amplifier into clip, from approximately +90dBu with the controls fully counter clockwise, to +1dBu with the controls full clockwise. +1dBu equals approximately 870mV RMS and this level will be just sufficient with a 4 ohm load and nominal AC voltage to drive the amplifier into clip. If pairs of amplifier channels are being operated in bridge mode, the channel 1 level controls operate the 1+2 pair volume and the channel 3 level controls the 3+4 pair volume. The controls for channels 2 and 4 do not have any effect in bridge mode.

Supplied with each PULSE amplifier are special blanking plugs that may be fitted after the control knobs have been pulled off thus allowing the levels to be set and then made tamper proof.

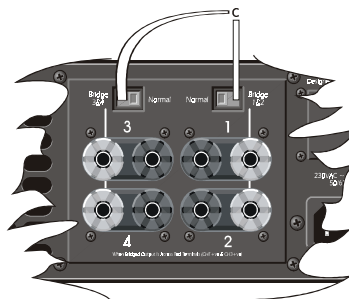

c. Bridge switches

Located on the rear panel, these switches enable bridge mode operation. One switch is for channels 1+2, the other for channels 3+4. Activation of these switches is indicated by the corresponding 'Bridge' indicator on the front panel.

When a pair of the amplifier channels is operated in bridge mode, the power available doubles allowing larger speakers to be driven. Two things must be kept in mind when bridge mode is used, namely the minimum impedance that can be driven increases from 2 ohms to 4 ohms and if binding post outputs are used, the speaker wiring must be changed as described in **4.0 Audio Connections** section of this manual.

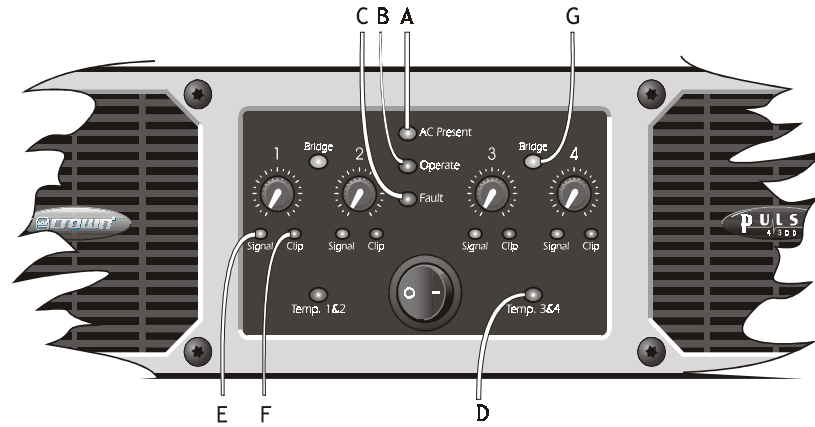

A. AC Present

This light glows when AC power is applied to the amplifier, whether or not the amplifier is actually running. This light will still glow even if the rear panel fuse is blown because it is powered from the separate, internally fused supply that powers the microprocessor.

B. Operate

Illuminated when the main power supply is switched on using the front panel switch.

C. Fault

If, for any reason, the microprocessor detects a problem then this light comes on. If it is not flashing the problem is with one or more of the amplifier channels. If it flashes, the processor has been unable to start the main power supply; this may be because the power supply has become too hot, or because the rear panel fuse has failed. If letting the amplifier cool and/or replacing the fuse does not clear the problem, the amplifier must be returned to an authorized service center for repair.

Under some circumstances, the *Fault* light might flash with a period of about 3 seconds along with the *Power* light and various clicking noises. This is because the processor is trying to power up the amplifier but is detecting an error, aborting, and then retrying. This may either continue indefinitely (for example a shorted output in bridge mode) or stop after a number of attempts.

D. Temp 1-2 & 3-4

These lights come on if the microprocessor detects that the corresponding channel's heatsink has exceeded the maximum allowed temperature. If the light is on, that channel will have been muted. Once the heatsink has cooled, normal operation will resume. This cycling will be allowed to continue indefinitely.

During normal to heavy use, the substantial heatsinks used in PULSE amplifiers should ensure that these lights never come on, however if the front air intakes, rear air exhausts or any fan filters fitted become blocked an over temperature condition may occur.



E. Signal

This indicator lights when a signal exceeding approximately -26dBu is applied to a channel. In bridge mode only the channel 1 and/or channel 3 light operate(s).

F. Clip

This light is in fact rather more sophisticated than a simple clip indicator; it actually measures distortion. This may occur either due to clipping, trying to drive too low an impedance speaker load or any other mechanism that causes the output of the amplifier channel to not be as expected by the monitoring circuit. Note that if the amplifier channel is muted by the microprocessor and a signal is applied, the clip light will come on.

G. Bridge

If this light is on it indicates that a given channel pair has been configured for bridge mode operation by the rear panel switch.



a. Four Channel Sound Reinforcement

In this example, each channel of the PULSE 4x300 is being used independently to control the sound level in all four corners of a venue. For this application, ensure that both rear panel BRIDGE switches are in the NORMAL position. More than one speaker may be used on each channel as long as the total impedance is not less than 2 ohms. See *section 7e* of this manual for more information about how to calculate impedance.

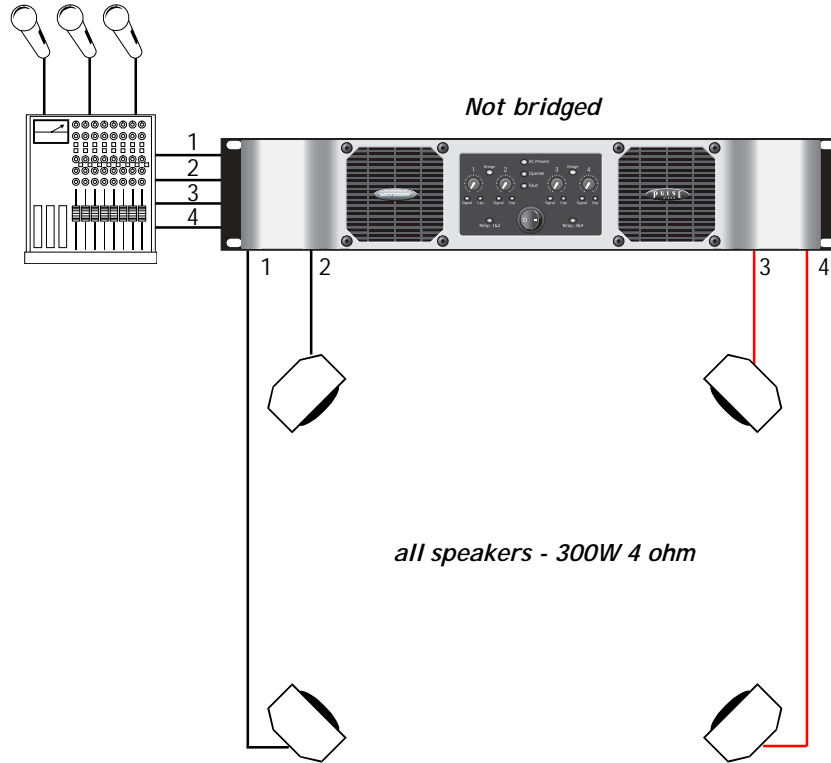

b. Two Channel (Stereo) Operation

For this application the PULSE 4x300 is used with channels 1+2 and 3+4 in bridge mode, achieved by operating the rear panel switches and confirmed by the front panel bridge lights. When operated in this way, each bridged pair can deliver over 600W into 4 ohms. Note that in bridge mode, 2 ohm operation is not permitted, 4 ohms is the minimum permissible load. If less than 4 ohms is detected, the amplifier may repeatedly mute at 4 second intervals. See *section 7e* of this manual for more information about how to calculate impedance.

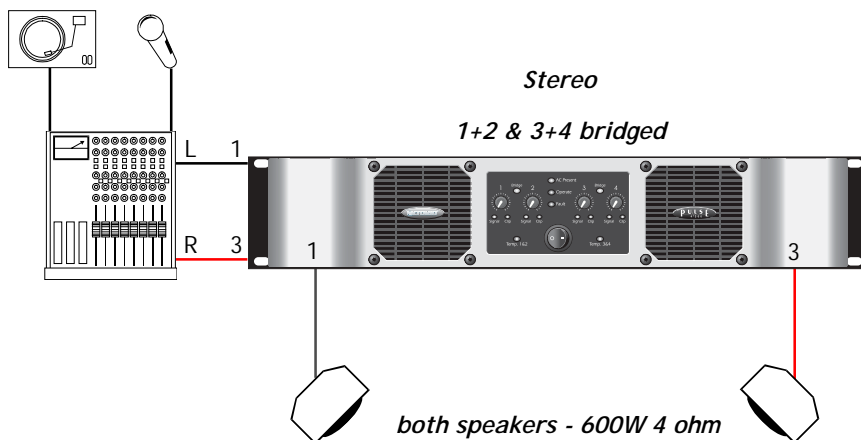

c. Three channel operation

This configuration demonstrates the flexibility of the PULSE 4x300. Channels 1+2 are bridged and drive a 600W 4 ohm sub-bass speaker. Channels 3 and 4 are used independently to drive two 300W 4 ohm mid-high speakers using an external crossover unit between the mixer and the amplifier.

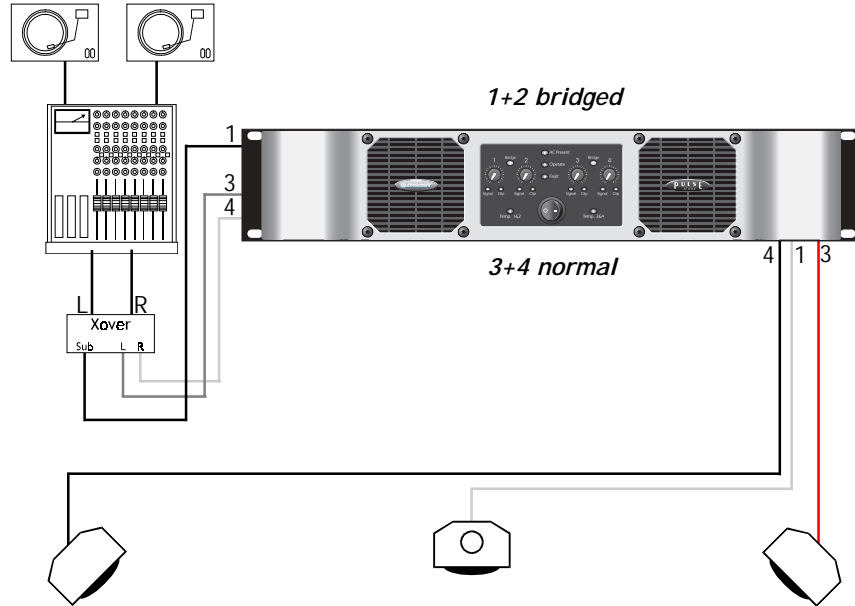

d. Four Channels Driving Two Actively Crossed 2 Way Monitors

Capable of driving a pair of 2 way monitors, the PULSE 4x300 is great for tour sound. As all channels are used independently in this application, the speakers may be 2 ohm impedance if required. See **section 7e** of this manual for more information about how to calculate impedance. A crossover to separate the respective frequencies for the mid bass and horn drivers will be necessary.

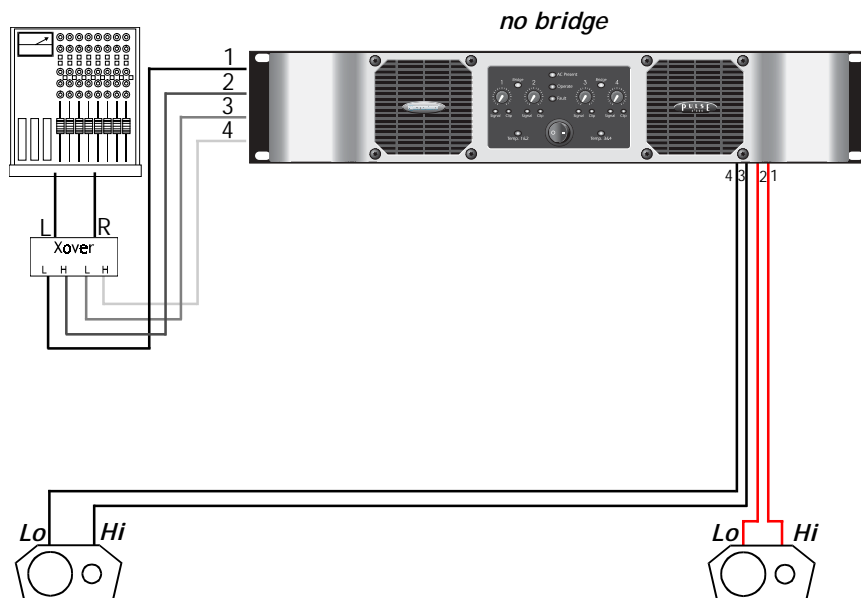

e. Calculating Impedance

Measured in ohms, impedance is a measure of AC resistance. Loudspeakers generally come in 16, 8 or 4 ohm varieties. Amplifiers have a lower limit to what impedance they can drive without being overloaded, there is not usually an upper limit. The PULSE 4x300 can drive any impedance between an open circuit and 2 ohms when in stereo and between an open circuit and 4 ohms when bridged.

When more than 1 speaker is used, it is easy to calculate the total impedance but remember that unless you are sure you know what you are doing, all the speakers should be the same impedance.

If the speakers are wired in series, just add their impedances together. If they are in parallel there is a simple rule: two impedances the same will equal half the individual impedance, for example $8 \ \& \ 8 = 4$ or to take this further, four 8 ohm drivers = 2 ohms ($8 \ \& \ 8 = 4 \dots 8 \ \& \ 8 = 4 \dots 4 \ \& \ 4 = 2$).



In this section many of the terms used throughout this manual are explained in more detail.

Active

Active electronic circuits are those which are capable of voltage and power gain by using transistors and integrated circuits.

Amplitude

Refers to the voltage level or intensity of a signal, and is usually measured in volts or decibels.

Balanced

A three wire connection in which two of the wires carry the signal information, the third acts as a shield tied to chassis ground. The two signal lines are of opposite polarity (out of phase by 180 degrees) at any given moment in time, and are of equal potential with respect to ground. Balanced connections are used to help reject induced hum and noise in system interconnections.

Binding Post

A type of connector that maybe used for either a bare wire or a wire terminated in a 4mm plug.

Bridge Mode

This applies to a method of combining two power amplifier channels to make one channel capable of providing approximately twice the power into a single load. This load must be connected across the two positive channel outputs.

Clip or Clipping

The term used to describe an overdrive condition in a piece of equipment. A clipped signal is distorted and will sound harsh. Applying a heavily clipped signal to a loudspeaker, whilst not unduly affecting the amplifier, may cause speaker damage.

dB

A unit for expressing the ratio between two signal levels for comparison purposes. On its own it has no absolute level meaning. Rather, it is a logarithmic ratio used to express the differences between two amounts or levels. Positive numbers indicate an increase, and negative ones a decrease.

Some useful ratios are:

$$\begin{aligned} +3\text{dB} &= \text{Double Power} \\ +6\text{dB} &= \times 2 \text{ Voltage or } \times 4 \text{ Power} \\ +10\text{dB} &= \times 3 \text{ Voltage or } \times 10 \text{ Power} \\ +20\text{dB} &= \times 10 \text{ Voltage or } \times 100 \text{ Power} \end{aligned}$$

dBm

The addition of 'm' after dB indicates an absolute scaling for the dB ratio. Instead of a ratio, the dB becomes a measure of voltage. 0dBm = a power level of 1 milliwatt into a load of 600 ohms. It is also loosely used to describe signal voltage in 600 ohm circuits.

dBu or dBv

The addition of a lower case "u" or "v" after dB indicates an absolute scaling for the dB ratio. 0dBu (or 0 dBv) = 778mV or 0.778 Volts, and it has no regard for power or impedance. This term is widely used for expressing signal voltages in modern audio equipment with high input impedances and low output impedances. For dBv the same scale is used as for dBu above, except that 0dBV = 1.0 Volts.

Distortion

Any modification of a signal which produces new frequency components not present in the original. Harmonic distortion refers to added frequencies that are overtones to the fundamental frequency. Intermodulation distortion refers to added frequencies that are sum and difference values derived from the beating together of two frequencies.

Frequency

The repetition of a waveform. The unit of frequency is Hz, and 1 cycle per second is equal to 1Hz. The audio band is generally restricted to frequencies of 20Hz to 20,000Hz (20kHz).

Frequency Response

The equipment's relative gain compared to frequency. Generally expressed as +/- a certain number of dBs from 20Hz to 20kHz.

Impedance

The AC equivalent of resistance and measured in ohms. It indicates the amount of drive required for an input, or the drive capability of an output, at a given signal level.

Level

The amplitude of a signal, measured in Volts or Decibels.

Line Level

Generally indicates a signal whose level is between -10 and +10dBu or -14 to +6 dBV. Mic level refers to levels around -40dBu.

Noise

The term given to any signals appearing at the output of a piece of equipment when no input signal is applied. Most commonly, noise takes the form of hum, buzz or hiss.

Octave

A logarithmic unit for expressing frequency ratios. Positive values indicate an increase and negative ones a decrease. One octave 'up' the scale is equivalent to double the frequency. One octave 'down' is equivalent to half the frequency.



Transient

A sudden burst of energy in an audio signal which only lasts for a small period of time relative to the rest of the signal. The level of these transients can often reach 10 times (+20dB) or so above the normal operating level of the audio equipment, and may cause distortion if headroom is inadequate.

Speakon®

A type of connector, manufactured by Neutrik with either 2, 4 or 8 pole connectors, specifically designed for connecting speakers to amplifiers. PULSE amplifiers and the majority of loudspeakers use the 4 pole type.

XLR

A type of connector used by audio professionals for connecting audio line, or microphone level signals to equipment. Usually three pole. Note that some XLRs may be carrying AES/EBU digital signals and these should not be plugged into audio channels.

Power Ratings **Pulse 4x300***Stereo*

Measured per channel, both channels driven at 1kHz to no more than 0.1% THD+N

8 ohms	170W rms
4 ohms	300W rms
2 ohms	330W rms*

* Note: 2 ohm spec is at 1% THD

Bridged Mono

16 ohms	400W rms
8 ohms	600W rms
4 ohms	660W rms*

* Note: 4 ohm bridged spec is at 1% THD

Input Sensitivity	+1dBu for full output
Input Impedance	20 kohm
Input Connectors	1/4-inch TRS balanced phone jack and female XLR
Distortion	<0.006% THD , 1kHz, 1dB below clip, 22kHz measurement bandwidth
Frequency Response	20Hz to 20kHz , +0/-0.2dB; <2Hz to >120kHz +0/-3dB
Controls	Power switch, bridge mode switches, indented level controls (these may be made tamper-proof)
Indicators	AC Present, Operate, Signal, Bridge, Clip, Temp., Fault
Protection	Microprocessor supervised: Over-temperature, DC on outputs, output stage overload, inrush current surge, power fail and brownout
Noise	<-100dB ref. full output 20Hz - 20kHz measurement bandwidth
Slew Rate	>50 V/microsecond
Damping Factor	>200 ref. 8 ohm
Output Connectors	Binding post or Speakon [®] options
AC Power	230 volts AC nominal, 2200VA, all channels driven
Dimensions	3.5" (89mm) x 18.2" (460mm) x 19" (483mm)
Weight	24lbs (11kg)



Checklist

Problem: No output

- Check: Are the **AC Present** and **Operate** lights *on*?
- Are the **Fault & Temp** lights *off*?
- Are the **Signal** lights *on*?
- Are the level controls turned up?
- Are the speakers *properly* connected? (in particular check that older style 'ring lock' type Speakons are rotated in the socket).

Problem: Distorted sound

- Check: Are the **Clip** lights on?
- Is any equipment before the amp being over driven?
- Are any speaker cables shorted?
- Are the loudspeakers too low an impedance?
- Are the input cables wired correctly?

Problem: Hum or buzzing

- Check: Is the amp properly grounded?
- Are the input cables shielded?
- Are the input connectors properly wired?
- Are you using an unbalanced input?
- Does the noise stop if the equipment driving the amp is switched off?

Status Indication

There is a microprocessor inside each PULSE amplifier responsible for monitoring all critical systems. The status of which are displayed on the front panel lights.

Their indication is as follows:

Fault and both Temp lights flashing

The amplifier has just been plugged in and the microprocessor is carrying out a test sequence. This is normal and will stop after about 7 seconds.

Power light on, Operate light off, Fault light on & flashing

The microprocessor has been unable to start the main power supply. If the condition persists for more than 1 hour without an input signal, check the rear panel fuse. If the fuse is blown and a replacement also fails (or the fault persists), return the amplifier to an authorized service center. Information is in the ***Service & Warranty section***.

Power light on, Operate light off, Fault light on (not flashing)

(The Operate and Fault light may be flashing very slowly accompanied by internal clicking). A fault has been detected with one or more of the amplifier channels and the processor has shut down the power supply to protect both the amplifier and your speakers. Depending on the fault it may try to resume operation again indefinitely, or give up after a number of attempts. If after disconnecting all input and output leads and switching the amplifier off and on again (to reset it), the condition persists, return the amplifier to an authorized service center. Information is given in the ***Service & Warranty section***.

Power light on, Operate light on, Fault light on, Temp light on

One or both of the heatsinks have exceeded their maximum temperature. When in this condition, the channel associated with each Temp light will be muted until the temperature has fallen to a safe level. Normal operation will then automatically resume. The most likely causes of an over-temperature condition are blocked rear air intake, obstructed front air exhausts or, if fitted, clogged fan filters.



Crown amplifiers are quality units that rarely require servicing. Before returning your unit for servicing, please contact Crown Technical Support to verify the need for servicing.

This unit has very sophisticated circuitry which should only be serviced by an authorized Crown Service Center. This is one reason why each unit bears the following label:



CAUTION: To prevent electric shock, do not remove covers. No user serviceable parts inside. Refer servicing to a qualified technician.

Worldwide Service

Service may be obtained from an authorized service center. Contact your local Crown/Amcron distributor or our office for a list of authorized service centers. To obtain service, simply present the receipt as proof of purchase along with the defective unit to an authorized distributor. They will handle the necessary paperwork and repair.

Remember to transport your unit in the original factory pack.

Service Shipping Instructions:

1. Contact your local Crown distributor for details regarding where to send your amplifier. This information is available on the Crown website or by contacting Crown Audio Customer Service, see details panel.

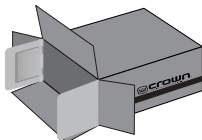

Always use the original factory pack to transport the unit.

2. To ensure the safe transportation of your unit to the factory, ship it in an original factory packing container. If you don't have one, call or write Crown's Parts Department. With the exception of polyurethane or wooden crates, any other packing

material will not be sufficient to withstand the stress of shipping. **Do not use loose, small size packing materials.**

3. Do not ship the unit in any kind of cabinet (wood or metal). Ignoring this warning may result in extensive damage to the unit and the cabinet. Accessories are not needed—do not send the product documentation, cables and other hardware.

If you have any questions, please call or write the Crown Technical Support Group.

Crown Audio Customer Service

Technical Support / Factory Service
Plant 2 SW, 1718 W. Mishawaka Rd., Elkhart,
Indiana 46517 U.S.A.

Telephone: 219-294-8200
800-342-6939 (North America,
Puerto Rico, and Virgin Islands only)

Facsimile: 219-294-8301 (Technical Support)
219-294-8124 (Factory Service)

Internet: <http://www.crownaudio.com>



THREE YEAR FULL WARRANTY



UNITED STATES & CANADA

SUMMARY OF WARRANTY

Crown International, 1718 West Mishawaka Road, Elkhart, Indiana 46517-4095 U.S.A. warrants to you, the ORIGINAL PURCHASER and ANY SUBSEQUENT OWNER of each NEW Crown product, for a period of three (3) years from the date of purchase by the original purchaser (the "warranty period") that the new Crown product is free of defects in materials and workmanship. We further warrant the new Crown product regardless of the reason for failure, except as excluded in this Warranty.

ITEMS EXCLUDED FROM THIS CROWN WARRANTY

This Crown Warranty is in effect only for failure of a new Crown product which occurred within the Warranty Period. It does not cover any product which has been damaged because of any intentional misuse, accident, negligence, or loss which is covered under any of your insurance contracts. This Crown Warranty also does not extend to the new Crown product if the serial number has been defaced, altered, or removed.

WHAT THE WARRANTOR WILL DO

We will remedy any defect, regardless of the reason for failure (except as excluded), by repair, replacement, or refund. We may not elect refund unless you agree, or unless we are unable to provide replacement, and repair is not practical or cannot be timely made. If a refund is elected, then you must make the defective or malfunctioning product available to us free and clear of all liens or other encumbrances. The refund will be equal to the actual purchase price, not including interest, insurance, closing costs, and other finance charges less a reasonable depreciation on the product from the date of original purchase. Warranty work can only be performed at our authorized service centers or at the factory. We will remedy the defect and ship the product from the service center or our factory within a reasonable time after receipt of the defective product at our authorized service center or our factory. All expenses in remedying the defect, including surface shipping costs in the United States, will be borne by us. (You must bear the expense of shipping the product between any foreign country and the port of entry in the United States including the return shipment, and all taxes, duties, and other customs fees for such foreign shipments.)

HOW TO OBTAIN WARRANTY SERVICE

You must notify us of your need for warranty service within the warranty period. All components must be shipped in a factory pack, which, if needed, may be obtained from us free of charge. Corrective action will be taken within a reasonable time of the date of receipt of the defective product by us or our authorized service center. If the repairs made by us or our authorized service center are not satisfactory, notify us or our authorized service center immediately.

DISCLAIMER OF CONSEQUENTIAL AND INCIDENTAL DAMAGES
YOU ARE NOT ENTITLED TO RECOVER FROM US ANY INCIDENTAL DAMAGES RESULTING FROM ANY DEFECT IN THE NEW CROWN PRODUCT. THIS INCLUDES ANY DAMAGE TO ANOTHER PRODUCT OR PRODUCTS RESULTING FROM SUCH A DEFECT. **SOME STATES DO NOT ALLOW THE EXCLUSION OR LIMITATIONS OF INCIDENTAL OR CONSEQUENTIAL DAMAGES, SO THE ABOVE LIMITATION OR EXCLUSION MAY NOT APPLY TO YOU.**

WARRANTY ALTERATIONS

No person has the authority to enlarge, amend, or modify this Crown Warranty. This Crown Warranty is not extended by the length of time which you are deprived of the use of the new Crown product. Repairs and replacement parts provided under the terms of this Crown Warranty shall carry only the unexpired portion of this Crown Warranty.

DESIGN CHANGES

We reserve the right to change the design of any product from time to time without notice and with no obligation to make corresponding changes in products previously manufactured.

LEGAL REMEDIES OF PURCHASER

THIS CROWN WARRANTY GIVES YOU SPECIFIC LEGAL RIGHTS. YOU MAY ALSO HAVE OTHER RIGHTS WHICH VARY FROM STATE TO STATE. No action to enforce this Crown Warranty shall be commenced after expiration of the warranty period.

THIS STATEMENT OF WARRANTY SUPERSEDES ANY OTHERS CONTAINED IN THIS MANUAL FOR CROWN PRODUCTS.

Visit www.crownaudio.com for a list of Crown authorized service centers.

Telephone: 219-294-8200. Facsimile: 219-294-8301 7/01

WORLDWIDE EXCEPT USA & CANADA

SUMMARY OF WARRANTY

Crown International, 1718 West Mishawaka Road, Elkhart, Indiana 46517-4095 U.S.A. warrants to you, the ORIGINAL PURCHASER and ANY SUBSEQUENT OWNER of each NEW Crown¹ product, for a period of three (3) years from the date of purchase by the original purchaser (the "warranty period") that the new Crown product is free of defects in materials and workmanship, and we further warrant the new Crown product regardless of the reason for failure, except as excluded in this Warranty.

¹ Note: If your unit bears the name "Amcron," please substitute it for the name "Crown" in this warranty.

ITEMS EXCLUDED FROM THIS CROWN WARRANTY

This Crown Warranty is in effect only for failure of a new Crown product which occurred within the Warranty Period. It does not cover any product which has been damaged because of any intentional misuse, accident, negligence, or loss which is covered under any of your insurance contracts. This Crown Warranty also does not extend to the new Crown product if the serial number has been defaced, altered, or removed.

WHAT THE WARRANTOR WILL DO

We will remedy any defect, regardless of the reason for failure (except as excluded), by repair, replacement, or refund. We may not elect refund unless you agree, or unless we are unable to provide replacement, and repair is not practical or cannot be timely made. If a refund is elected, then you must make the defective or malfunctioning product available to us free and clear of all liens or other encumbrances. The refund will be equal to the actual purchase price, not including interest, insurance, closing costs, and other finance charges less a reasonable depreciation on the product from the date of original purchase. Warranty work can only be performed at our authorized service centers. We will remedy the defect and ship the product from the service center within a reasonable time after receipt of the defective product at our authorized service center.

HOW TO OBTAIN WARRANTY SERVICE

You must notify your local Crown importer of your need for warranty service within the warranty period. All components must be shipped in the original box. Corrective action will be taken within a reasonable time of the date of receipt of the defective product by our authorized service center. If the repairs made by our authorized service center are not satisfactory, notify our authorized service center immediately.

DISCLAIMER OF CONSEQUENTIAL AND INCIDENTAL DAMAGES
YOU ARE NOT ENTITLED TO RECOVER FROM US ANY INCIDENTAL DAMAGES RESULTING FROM ANY DEFECT IN THE NEW CROWN PRODUCT. THIS INCLUDES ANY DAMAGE TO ANOTHER PRODUCT OR PRODUCTS RESULTING FROM SUCH A DEFECT.

WARRANTY ALTERATIONS

No person has the authority to enlarge, amend, or modify this Crown Warranty. This Crown Warranty is not extended by the length of time which you are deprived of the use of the new Crown product. Repairs and replacement parts provided under the terms of this Crown Warranty shall carry only the unexpired portion of this Crown Warranty.

DESIGN CHANGES

We reserve the right to change the design of any product from time to time without notice and with no obligation to make corresponding changes in products previously manufactured.

LEGAL REMEDIES OF PURCHASER

No action to enforce this Crown Warranty shall be commenced after expiration of the warranty period.

THIS STATEMENT OF WARRANTY SUPERSEDES ANY OTHERS CONTAINED IN THIS MANUAL FOR CROWN PRODUCTS.

Visit www.crownaudio.com for a list of Crown authorized service centers.

7/01

Telephone: 219-294-8200. Facsimile: 219-294-8301



*Crown is a registered trademark of Crown International.
Other trademarks are the property of their respective owners*

