

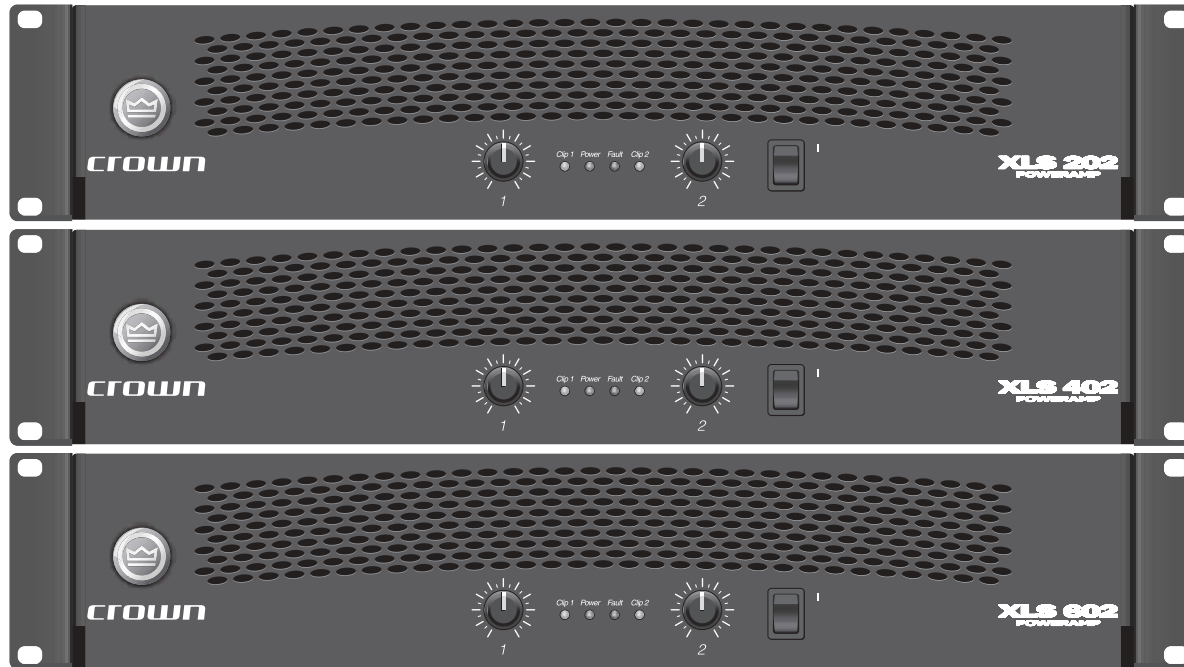

# XLS Series

Operation Manual



**XLS 202**

**XLS 402**

**XLS 602**

**Obtaining Other Language Versions:** To obtain information in another language about the use of this product, please contact your local Crown Distributor. If you need assistance locating your local distributor, please contact Crown at 574-294-8000.

This manual does not include all of the details of design, production, or variations of the equipment. Nor does it cover every possible situation which may arise during installation, operation or maintenance.

The information provided in this manual was deemed accurate as of the publication date. However, updates to this information may have occurred. To obtain the latest version of this manual, please visit the Crown website at [www.crownaudio.com](http://www.crownaudio.com).

**Trademark Notice:** Crown and Amcron are registered trademarks of Crown International. Other trademarks are the property of their respective owners.

**Some models may be exported under the name Amcron.®**

- 1) Read these instructions.
- 2) Keep these instructions.
- 3) Heed all warnings.
- 4) Follow all instructions.
- 5) Do not use this apparatus near water.
- 6) Clean only with a dry cloth.
- 7) Do not block any ventilation openings. Install in accordance with the manufacturer's instructions.
- 8) Do not install near any heat sources such as radiators, heat registers, stoves, or other apparatus that produce heat.
- 9) Do not defeat the safety purpose of the polarized or grounding-type plug. A polarized plug has two blades with one wider than the other. A grounding-type plug has two blades and a third grounding prong. The wide blade or the third prong is provided for your safety. If the provided plug does not fit into your outlet, consult an electrician for replacement of the obsolete outlet.
- 10) Protect the power cord from being walked on or pinched, particularly at plugs, convenience receptacles, and the point where they exit from the apparatus.
- 11) Only use attachments/accessories specified by the manufacturer.
- 12) Use only with a cart, stand, bracket, or table specified by the manufacturer, or sold with the apparatus. When a cart is used, use caution when moving the cart/apparatus combination to avoid injury from tip-over.
- 13) Unplug this apparatus during lightning storms or when unused for long periods of time.
- 14) Refer all servicing to qualified service personnel. Servicing is required when the apparatus has been damaged in any way, such as power-supply cord or plug is damaged, liquid has been spilled or objects have fallen into the apparatus, the apparatus has been exposed to rain or moisture, does not operate normally, or has been dropped.
- 15) To reduce the risk of fire or electric shock, do not expose this apparatus to rain or moisture.



TO PREVENT ELECTRIC SHOCK DO NOT REMOVE TOP OR BOTTOM COVERS. NO USER SERVICEABLE PARTS INSIDE. REFER SERVICING TO QUALIFIED SERVICE PERSONNEL.

À PRÉVENIR LE CHOC ÉLECTRIQUE N'ENLEVEZ PAS LES COUVERCLES. IL N'Y A PAS DES PARTIES SERVICEABLE À L'INTÉRIEUR. TOUS REPARATIONS DOIT ÊTRE FAIRE PAR PERSONNEL QUALIFIÉ SEULMENT.



**CAUTION**  
RISK OF ELECTRIC SHOCK  
DO NOT OPEN



**AVIS**  
RISQUE DE CHOC ÉLECTRIQUE  
N'OUVREZ PAS

#### IMPORTANT

XLS Series amplifiers require Class 2 output wiring.



#### MAGNETIC FIELD

CAUTION! Do not locate sensitive high-gain equipment such as preamplifiers or tape decks directly above or below the unit. Because this amplifier has a high power density, it has a strong magnetic field which can induce hum into unshielded devices that are located nearby. The field is strongest just above and below the unit.



If an equipment rack is used, we recommend locating the amplifier(s) in the bottom of the rack and the preamplifier or other sensitive equipment at the top.

#### WATCH FOR THESE SYMBOLS:

The lightning bolt triangle is used to alert the user to the risk of electric shock.



The exclamation point triangle is used to alert the user to important operating or maintenance instructions.



### FCC COMPLIANCE NOTICE

This device complies with part 15 of the FCC rules. Operation is subject to the following two conditions: (1) This device may not cause harmful interference, and (2) this device must accept any interference received, including interference that may cause undesired operation.

CAUTION: Changes or modifications not expressly approved by the party responsible for compliance could void the user's authority to operate the equipment.

NOTE: This equipment has been tested and found to comply with the limits for a Class B digital device, pursuant to part 15 of the FCC Rules. These limits are designed to provide reasonable protection against harmful interference in a residential installation. This equipment generates, uses, and can radiate radio frequency energy and, if not installed and used in accordance with the instruction manual, may cause harmful interference to radio communications. However, there is no guarantee that interference will not occur in a particular installation. If this equipment does cause harmful interference to radio or television reception, which can be determined by turning the equipment off and on, the user is encouraged to try to correct the interference by one or more of the following measures:

- Reorient or relocate the receiving antenna.
- Increase the separation between the equipment and receiver.
- Connect the equipment into an outlet on a circuit different from that to which the receiver is connected.
- Consult the dealer or an experienced radio/TV technician for help.

Crown International, Inc.

**DECLARATION of CONFORMITY**

**Issued By:** Crown International, Inc.  
1718 W. Mishawaka Road  
Elkhart, Indiana 46517 U.S.A.

Sue Whitfield  
574-294-8289  
swhitfield@crowintl.com

**European Representative's Name and Address:**

Nick Owen  
19 Clos Nant Coslech  
Pontprennau  
Cardiff  
CF23 8ND United Kingdom

**Equipment Type:** Commercial Audio Power Amplifiers

**Family Name:** XLS Amplifiers

**Model Names:** XLS 202, XLS 402, XLS 602, XLS 402TX, XLS 602TX

**EMC Standards:**

**EN 55103-1:1995** Electromagnetic Compatibility - Product Family Standard for Audio, Video, Audio-Visual and Entertainment Lighting Control Apparatus for Professional Use, Part 1: Emissions

**EN 55103-1:1995** Magnetic Field Emissions-Annex A @ 10 cm and 1 M

**EN 61000-3-2:1995+A14:2000** Limits for Harmonic Current Emissions (equipment input current 16A per phase)

**EN 61000-3-3:1995** Limitation of Voltage Fluctuations and Flicker in Low-Voltage Supply Systems Rated Current 16A

**EN 55022:1992 + A1: 1995 & A2:1997** Limits and Methods of Measurement of Radio Disturbance Characteristics of ITE: Radiated, Class B Limits; Conducted, Class B

**EN 55103-2:1996** Electromagnetic Compatibility - Product Family Standard for Audio, Video, Audio-Visual and Entertainment Lighting Control Apparatus for Professional Use, Part 2: Immunity

**EN 61000-4-2:1995** Electrostatic Discharge Immunity (Environment E2-Criteria B, 4k V Contact, 8k V Air Discharge)

**EN 61000-4-3:1996** Radiated, Radio-Frequency, Electromagnetic Immunity (Environment E2, Criteria A)

**EN 61000-4-4:1995** Electrical Fast Transient/Burst Immunity (Criteria B)

**EN 61000-4-5:1995** Surge Immunity (Criteria B)

**EN 61000-4-6:1996** Immunity to Conducted Disturbances Induced by Radio-Frequency Fields (Criteria A)

**EN 61000-4-11:1994** Voltage Dips, Short Interruptions and Voltage Variation

**Safety Standard:**

**EN 60065: 1998** Safety Requirements - Audio Video and Similar Electronic Apparatus

I certify that the product identified above conforms to the requirements of the EMC Council Directive 89/336/EEC as amended by 92/31/EEC, and the Low Voltage Directive 73/23/EES as amended by 93/68/EEC.

Signed

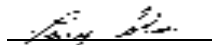

Larry Colburn

Title: Senior Vice President of Manufacturing

Date of Issue: January 1, 2001

## Table of Contents

Important Safety Instructions .....	2	<b>4 Advanced Features and Options .....</b>	15
Declaration of Conformity .....	3	4.1 Protection Systems .....	15
<b>1 Welcome .....</b>	5	4.1.1 Output Current Limiting.....	15
1.1 Features .....	5	4.1.2. DC Protection .....	15
1.2 How to Use This Manual .....	5	4.1.3 Circuit Breaker.....	15
<b>2 Setup .....</b>	6	4.1.4 Thermal Protection .....	15
2.1 Unpack Your Amplifier .....	6	<b>5 Troubleshooting .....</b>	16
2.2 Install Your Amplifier .....	6	<b>6 Specifications .....</b>	17
2.3 Ensure Proper Cooling .....	6	<b>7 AC Power Draw and Thermal Dissipation .....</b>	19
2.4 Choose Input Wire and Connectors .....	7	<b>8 Service .....</b>	22
2.5 Choose Output Wire and Connectors .....	7	8.1 Worldwide Service .....	22
2.6 Wire Your System .....	8	8.2 US and Canada Service .....	22
2.6.1 Stereo Mode Using the 5-way Binding Posts.....	8	8.2.1 Service at a US or Canada Service Center .....	22
2.6.2 Stereo Mode Using the Speakon® Connector .....	9	8.2.2 Factory Service .....	22
2.6.3 Bridge-Mono Mode .....	10	8.2.3 Factory Service Shipping Instructions .....	22
2.7 Connect to AC Mains .....	11	<b>9 Warranty .....</b>	23
2.8 Protecting Your Speakers .....	11	Crown Factory Service Information Form .....	25
2.9 Startup Procedure .....	11		
<b>3 Operation .....</b>	12		
3.1 Precautions .....	12		
3.2 Front Panel Controls and Indicators .....	13		
3.3 Back Panel Controls and Connectors.....	14		

<b>XLS 202</b>	*1 kHz Power
2-ohm Stereo (per channel)	<b>250W</b>
4-ohm Stereo (per channel)	<b>200W</b>
8-ohm Stereo (per channel)	<b>145W</b>
8-ohm Bridge-Mono	<b>400W</b>
4-ohm Bridge-Mono	<b>500W</b>
*1 kHz Power: refers to maximum average power in watts at 1 kHz with 0.5% THD.	

<b>XLS 402</b>	*1 kHz Power
2-ohm Stereo (per channel)	<b>570W</b>
4-ohm Stereo (per channel)	<b>400W</b>
8-ohm Stereo (per channel)	<b>260W</b>
8-ohm Bridge-Mono	<b>800W</b>
4-ohm Bridge-Mono	<b>1,140W</b>
*1 kHz Power: refers to maximum average power in watts at 1 kHz with 0.5% THD.	

<b>XLS-602</b>	*1 kHz Power
2-ohm Stereo (per channel)	<b>840W</b>
4-ohm Stereo (per channel)	<b>600W</b>
8-ohm Stereo (per channel)	<b>370W</b>
8-ohm Bridge-Mono	<b>1,200W</b>
4-ohm Bridge-Mono	<b>1,680W</b>
*1 kHz Power: refers to maximum average power in watts at 1 kHz with 0.5% THD.	



## 1 Welcome

The XLS Series of power amplifiers from Crown represents a new era in affordable, quality power amplification. The line consists of three models in a uniform, rugged chassis, incorporating the best of tried-and-true design principles and innovative features.

Modern power amplifiers are sophisticated pieces of engineering capable of producing extremely high power levels. They must be treated with respect and correctly installed if they are to provide the many years of reliable service for which they were designed.

In addition, XLS Series amplifiers include a number of features which require some explanation before they can be used to their maximum advantage.

Please take the time to study this manual so that you can obtain the best possible service from your amplifier.

### 1.1 Features

- Simple, reliable design incorporates many popular features.
- Housed in a rugged, all-steel 2U chassis.
- Efficient forced-air fan prevents excessive thermal buildup.
- Electronically balanced XLR inputs. Touch-proof binding post and Speakon® outputs.
- Features precision detented level controls, power switch, and four LEDs which indicate clip for each channel, power and fault conditions.

### 1.2 How to Use This Manual

This manual provides you with the necessary information to safely and correctly setup and operate your amplifier. It does not cover every aspect of installation, setup or operation that might occur under every condition. For additional information, please consult Crown's *Amplifier Application Guide* (available online at [www.crownaudio.com](http://www.crownaudio.com)), Crown Technical Support, your system installer or retailer.

We strongly recommend you read all instructions, warnings and cautions contained in this manual. Also, for your protection, please send in your warranty registration card today. And save your bill of sale — it's your official proof of purchase.

## 2 Setup

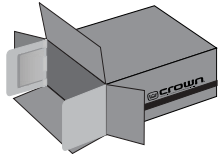

### 2.1 Unpack Your Amplifier

Please unpack and inspect your amplifier for any damage that may have occurred during transit. If damage is found, notify the transportation company immediately. Only you can initiate a claim for shipping damage. Crown will be happy to help as needed. Save the shipping carton as evidence of damage for the shipper's inspection.

We also recommend that you save all packing materials so you will have them if you ever need to transport the unit. **Never ship the unit without the factory pack.**

YOU WILL NEED (not supplied):

- Input wiring cables
- Output wiring cables

Rack for mounting amplifier (or a stable surface for stacking)



**WARNING:** Before you start to set up your amplifier, make sure you read and observe the Important Safety Instructions found at the beginning of this manual.

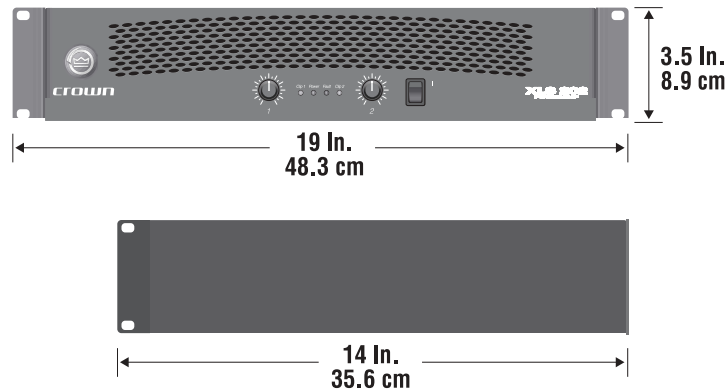

Figure 2.1  
Dimensions

### 2.2 Install Your Amplifier



**CAUTION:** Before you begin, make sure your amplifier is disconnected from the power source, with the power switch in the "off" position and all level controls turned completely down (counterclockwise).

Use a standard 19-inch (48.3 cm) equipment rack (EIA RS-310B). See Figure 2.1 for amplifier dimensions.

You may also stack amps without using a cabinet.

NOTE: When transporting, amplifiers should be supported at both front and back.

### 2.3 Ensure Proper Cooling

When using an equipment rack, mount units directly on top of each other. Close any open spaces in rack with blank panels. DO NOT block front, rear or side air vents. The side walls of the rack should be a minimum of two inches (5.1 cm) away from the amplifier sides, and the back of the rack should be a minimum of four inches (10.2 cm) from the amplifier back panel.

Figure 2.2 illustrates standard amplifier airflow.

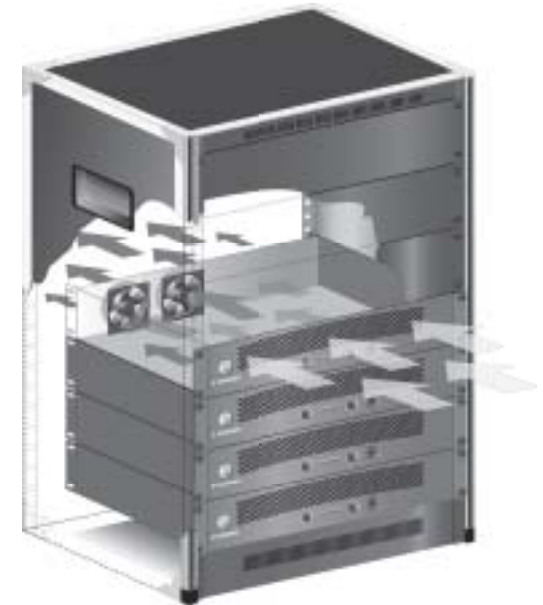

Figure 2.2 Airflow

## 2 Setup

### 2.4 Choose Input Wire and Connectors

Crown recommends using pre-built or professionally wired balanced line (two-conductor plus shield), 22-24 gauge cables and connectors. You should use 3-pin male XLR cable ends at the amplifier inputs. Unbalanced line may also be used but may result in noise over long cable runs.

Figure 2.3 shows connector pin assignments for balanced wiring, and Figure 2.4 shows connector pin assignments for unbalanced wiring.



**NOTE: Custom wiring should only be performed by qualified personnel.**

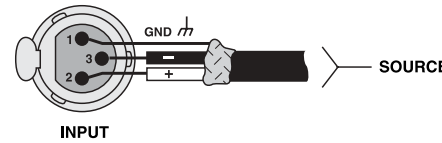

Figure 2.3  
Balanced Input  
Connector Wiring

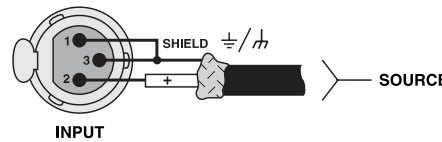

Figure 2.4  
Unbalanced Input  
Connector Wiring

### 2.5 Choose Output Wire and Connectors

Crown recommends using pre-built or professionally wired, high-quality, two- or four-conductor, heavy gauge speaker wire and connectors. You may use a 4-pole Speakon® connector (Figure 2.5 and Table 1) or banana plugs, spade lugs, or bare wire for your output connectors (Figure 2.6). To prevent the possibility of short-circuits, wrap or otherwise insulate exposed loudspeaker cable connectors.

**Note: Binding post outputs on European models come with safety plugs installed to prevent European power-cord plugs from being inserted. The top & bottom entry positions for these connectors should therefore be used with European models.**

Using the guidelines below, select the appropriate size of wire based on the distance from amplifier to speaker.

Distance	Wire Size
up to 25 ft.	16 AWG
26-40 ft.	14 AWG
41-60 ft.	12 AWG
61-100 ft.	10 AWG
101-150 ft.	8 AWG
151-250 ft.	6 AWG



Figure 2.5  
Left: Speakon® Output Connector on Back Panel  
Right: Speakon® Cable Connector

Table 1: Speakon Wiring

CH	1	1	2	2
PIN	1+	1-	2+	2-

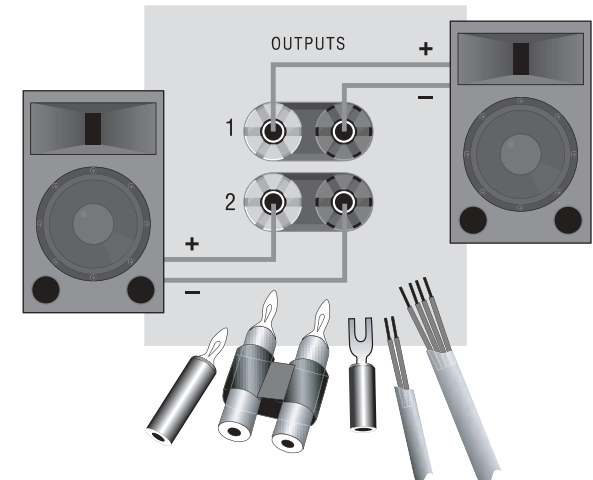

Figure 2.6  
5-Way Binding Post Connections



**CAUTION: Never use shielded cable for output wiring.**

## 2 Setup

### 2.6 Wire Your System

#### 2.6.1 Stereo Mode Using the 5-way Binding Posts

Typical input and output wiring is shown in Figure 2.7

**INPUTS:** Connect input wiring for both channels.

**OUTPUTS:** Maintain proper polarity (+/-) on output connectors.

Connect Channel 1 loudspeaker's positive (+) lead to Channel 1 positive (red) terminal of amp; repeat for negative (-). Repeat Channel 2 wiring as for Channel 1.

Figure 2.7 shows how to wire stereo speakers to the 5-way binding posts. The next page shows how to wire stereo speakers to the single Speakon® output connector.

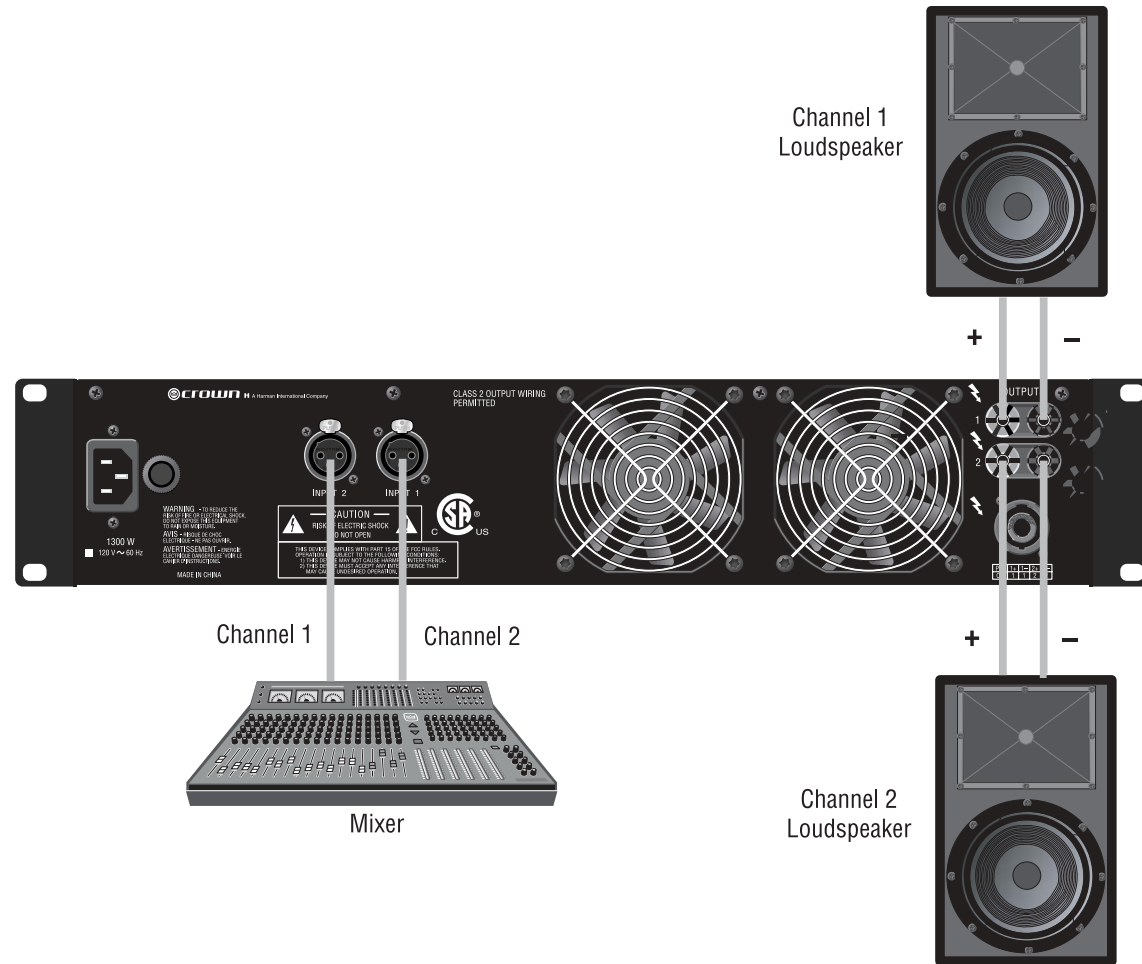

Figure 2.7  
System Wiring, Stereo Mode Using  
the 5-way Binding Posts



## 2 Setup

### 2.6.2 Stereo Mode Using the Speakon® Connector

There are two ways to wire two speakers in stereo to the amplifier's Speakon® connector.

1) Wire the two speakers to the same Speakon® connector as shown in Figure 2.8.

or

2) Wire speaker 1 to the amplifier's Speakon® connector, and wire speaker 2 to speaker 1 (Figure 2.9).

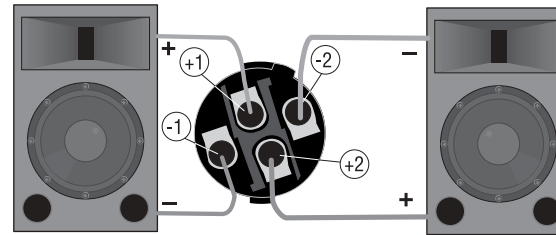

Figure 2.8 Speakon® Stereo Wiring Option 1:  
Wire Two Speakers to One Speakon® Connector

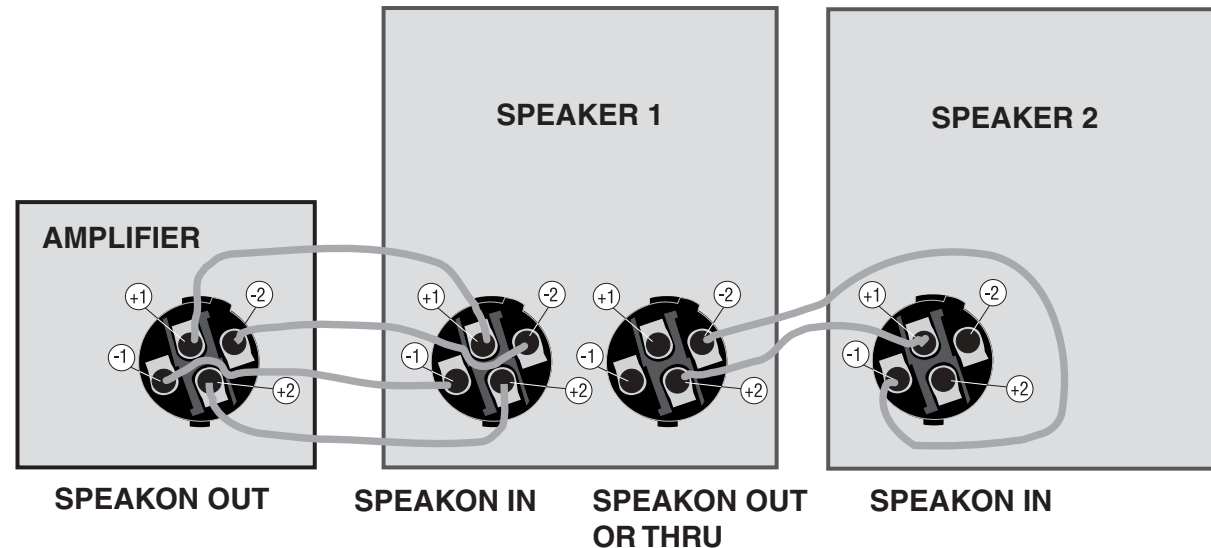

Figure 2.9 Speakon® Stereo Wiring Option 2:  
Wire Speaker 1 to the Amplifier's Speakon® Connector, and Wire Speaker 2 to Speaker 1

<b>CABLE 1: AMPLIFIER OUT TO SPEAKER 1 IN</b>	
1+	TO 1+
1-	TO 1-
2+	TO 2+
2-	TO 2-
<b>CABLE 2: SPEAKER 1 OUT TO SPEAKER 2 IN</b>	
2+	TO 1+
2-	TO 1-

## 2 Setup

### 2.6.3 Bridge-Mono Mode

**INPUTS:** Use a custom "Y" adapter cable, wired to split the signal and invert the polarity for the Channel 2 amplifier input as shown in Figure 2.10. We recommend you label the ends of the Y adapter to help make sure to connect the correct end to each amplifier input.

Connect the Y adapter between the signal source and each amplifier input (Figure 2.11).

**NOTE:** Crown provides a reference of wiring pin assignments for commonly used connector types in the Crown *Amplifier Application Guide* available at [www.crownaudio.com](http://www.crownaudio.com).

**OUTPUTS:** There are two ways to wire a speaker in Bridge-Mono mode:

1) Wire the speaker across the red binding post of each channel (Figure 2.11). Do not use the black binding posts when the amp is being operated in Bridge-Mono mode.

or

2) Wire the speaker to terminals 1+ and 2+ in the Speakon connector (Figure 2.12).

**NOTE: The Channel 1 and 2 level controls MUST be set to identical settings when operating the XLS amplifier in Bridge-Mono mode.**

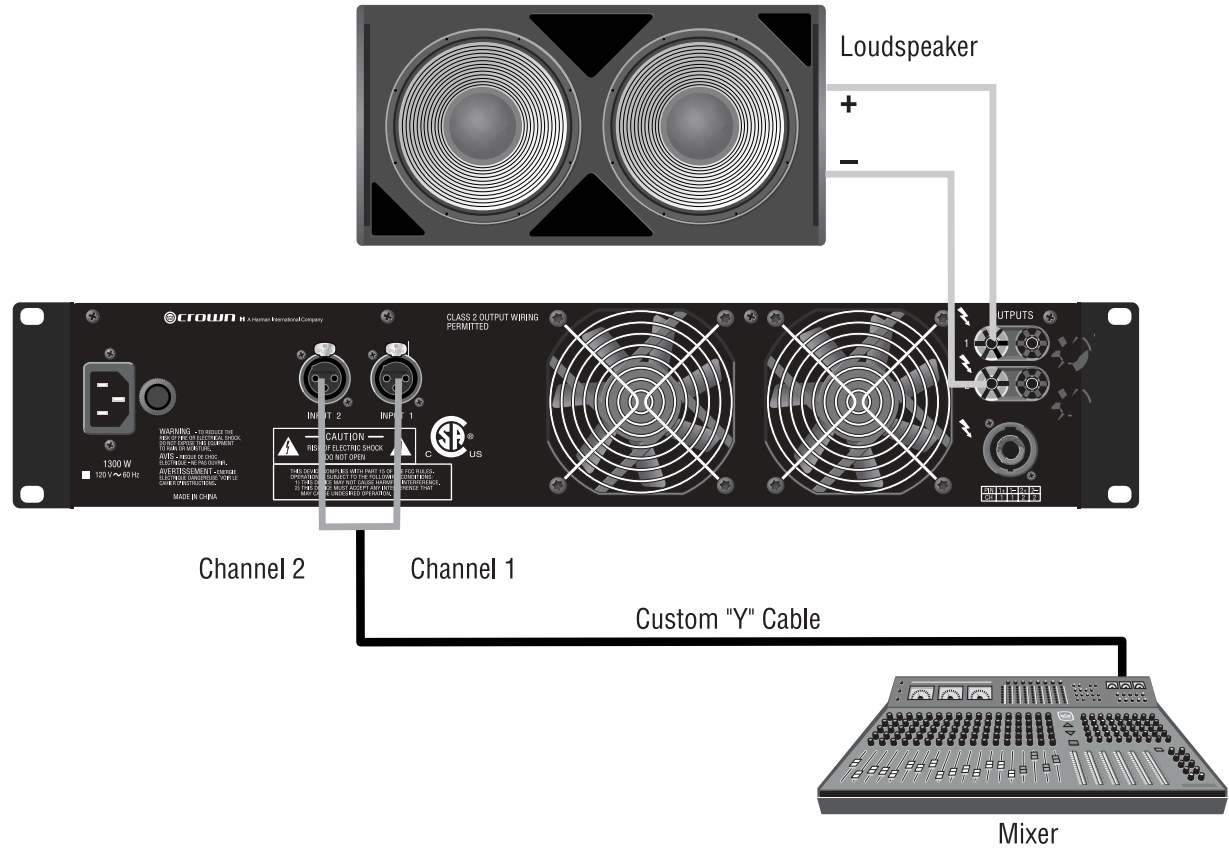

Figure 2.11 Bridge-Mono Wiring of Input and 5-Way Binding Post Output

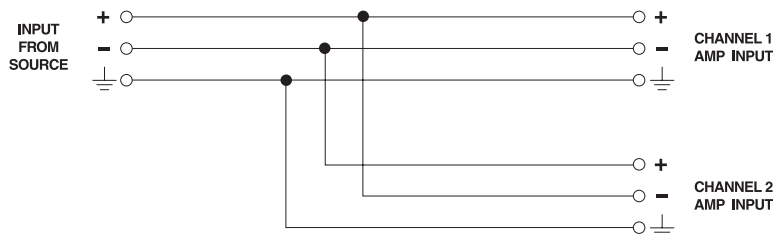

Figure 2.10 Custom Input Cable for Bridge-Mono Mode



Figure 2.12 Alternate Bridge-Mono Wiring: Loudspeaker Wired to Amplifier's Speakon® Connector

## 2 Setup

### 2.7 Connect to AC Mains

Connect your amplifier to the AC mains power source (power outlet) with the supplied AC power cordset. First, connect the IEC end of the cordset to the IEC connector on the amplifier; then, plug the other end of the cordset to the AC mains.



**WARNING: The third prong of this connector (ground) is an important safety feature. Do not attempt to disable this ground connection by using an adapter or other methods.**

Amplifiers don't create energy. The AC mains voltage and current must be sufficient to deliver the power you expect. You must operate your amplifier from an AC mains power source with not more than a 10% variation above or a 15% variation below the amplifier's specified line voltage and within the specified frequency requirements (indicated on the amplifier's back panel label). If you are unsure of the output voltage of your AC mains, please consult your electrician.

### 2.8 Protecting Your Speakers

It's wise to avoid clipping the amplifier signal. Not only does clipping sound bad, it can damage high-frequency drivers. To prevent clipping, insert a limiter between your mixer output and amplifier input. That way, no matter how strong a signal your mixer produces, the amplifier will not clip. Set the limiter threshold so that mixer signals above 0 on the mixer meters do not quite drive the amplifier into clipping.

Also, avoid sending strong subsonic signals to the amplifier. High-level, low-frequency signals from breath pops or dropped microphones can blow out drivers. To prevent subsonic signals, insert a high-pass filter between mixer output and amplifier input (or between mixer and limiter). Alternatively, switch in highpass filters at your mixer. Set the filter to as high a frequency as possible that does not affect your program. For example, try 35 Hz for music and 75 Hz for speech. On each mixer input channel, set the filter frequency just below the lowest fundamental frequency of that channel's instrument.

### 2.9 Startup Procedure

Use the following procedure when first turning on your amplifier:

1. Turn down the level of your audio source.
2. Turn down the level controls of the amplifier.
3. Turn on the "Power" switch. The Power indicator should glow.
4. Turn up the level of your audio source to an optimum level.
5. Turn up the Level controls on the amplifier until the desired loudness or power level is achieved.
6. Turn down the level of your audio source to its normal range.

If you ever need to make any wiring or installation changes, don't forget to disconnect the power cord.

For help with determining your system's optimum gain structure (signal levels) please refer to the *Crown Amplifier Application Guide*, available online at [www.crownaudio.com](http://www.crownaudio.com).



## 3 Operation

### 3.1 Precautions

Your amplifier is protected from internal and external faults, but you should still take the following precautions for optimum performance and safety:

1. Before use, your amplifier first must be configured for proper operation, including input and output wiring hookup. Improper wiring can result in serious operating difficulties. For information on wiring and configuration, please consult the Setup section of this manual or, for advanced setup techniques, consult Crown's *Amplifier Application Guide* available online at [www.crownaudio.com](http://www.crownaudio.com).
2. Use care when making connections, selecting signal sources and controlling the output level. The load you save may be your own!
3. Do not short the ground lead of an output cable to the input signal ground. This may form a ground loop and cause oscillations.



4. **WARNING: Never connect the output to a power supply, battery or power main. Electrical shock may result.**
5. Tampering with the circuitry, or making unauthorized circuit changes may be hazardous and invalidates all agency listings.
6. Do not operate the amplifier with the red Clip LEDs constantly flashing.
7. Do not overdrive the mixer, which will cause clipped signal to be sent to the amplifier. Such signals will be reproduced with extreme accuracy, and loudspeaker damage may result.
8. Do not operate the amplifier with less than the rated load impedance. Due to the amplifier's output protection, such a configuration may result in premature clipping and speaker damage. **Operating with a 2-ohm load is not recommended, as the amplifier might shut down.**

*Remember: Crown is not liable for damage that results from overdriving other system components.*

## 3 Operation

### 3.2 Front Panel Controls and Indicators

#### A. Cooling Vents

Front-to-rear forced airflow.

#### B. Level Controls

Two black rotary level controls, one for each channel.

#### C. Clip Indicators

Two red LEDs, one for each channel, illuminate when the channel's output signal is being overdriven.

#### D. Power Indicator

Green LED indicates amplifier has been turned on and AC power is available.

#### E. Fault Indicator

Yellow LED illuminates when amplifier is in protect mode. Also illuminates briefly during normal power-up when amplifier is first switched on.

#### F. Power Switch

Amplifier is on when the switch is in the UP position.

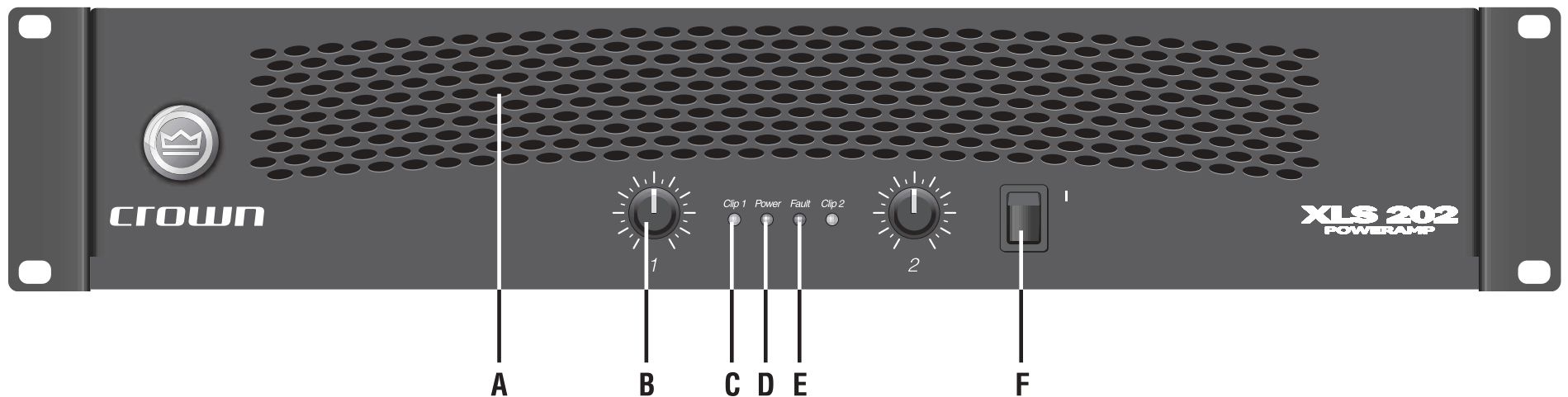

Figure 4.1 Front Panel Controls and Indicators

## 3 Operation

### 3.3 Back Panel Controls and Connectors

#### G. Power Connector

#### H. Circuit Breaker

Provides overload protection.

#### I. Balanced XLR Inputs

Two 3-pin female XLR input connectors are provided (one per channel).

#### J. Fans

Provide front-to-back forced airflow for cooling.

#### K. 5-Way Binding Post Output Jacks

One pair per channel; accept banana plugs, spade lugs or bare wire. Note: Binding post outputs on European models come with safety plugs installed to prevent European power-cord plugs from being inserted. The top & bottom entry positions for these connectors should therefore be used with European models.

#### L. 4-Pole Speakon Output Connector

One connector is used for the two output channels. It accepts a 4-pole Speakon connector. See Page 6, Figure 2.5 and Table 1 for connector wiring.

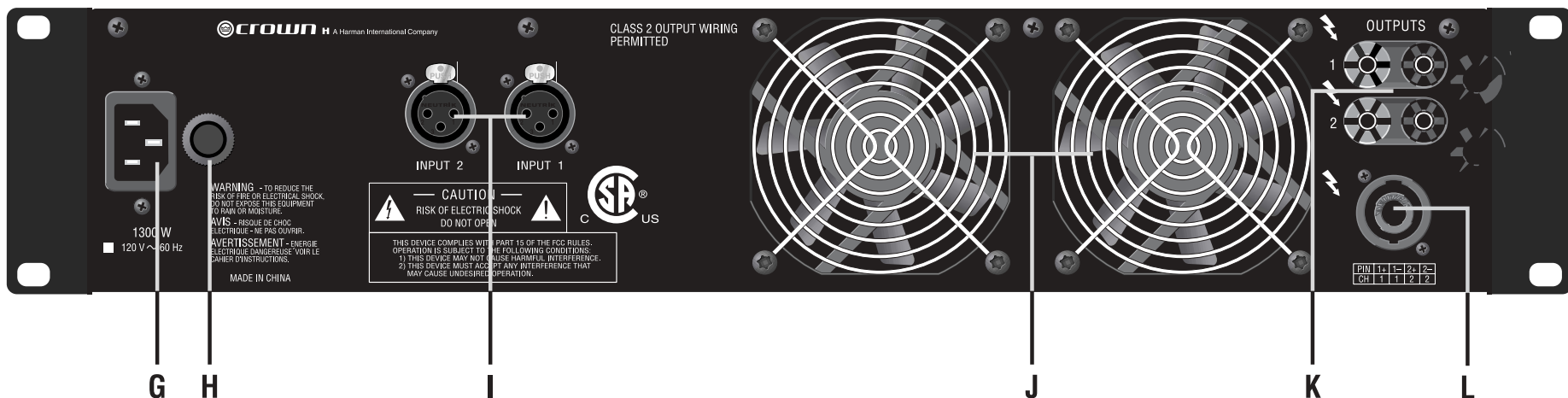

Figure 4.1 Back Panel Controls and Connectors

## 4 Advanced Features and Options

**NOTE:** For detailed information about these Crown amplifier features, please consult the *Crown Amplifier Application Guide*, available on the Crown website at [www.crownaudio.com](http://www.crownaudio.com).

### 4.1 Protection Systems

Your Crown amplifier provides extensive protection and diagnostic capabilities, including output current limiting, DC protection, circuit breaker, and special thermal protection for the unit's transformers.

#### 4.1.1 Output Current Limiting

Output Current Limiting circuitry protects the amplifier output stage for damage caused by short-circuit loads.

#### 4.1.2 DC Protection

DC Protection disconnects the loudspeaker load in the event of an output DC offset exceeding 2V. In such an event the yellow Fault LED will illuminate (see Figure 4.1) and both amplifier channels will be muted. In the majority of cases, DC protection is indicative of a faulty amplifier channel, and will be accompanied by an illuminated Clip LED, even with no input connected and level controls set at minimum. If this is the case, contact your dealer or service center.

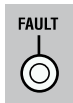

Figure 4.1  
Fault Indicator

#### 4.1.3 Circuit Breaker

The high-voltage power supplies of your Crown amplifier are protected by a circuit breaker. The breaker rating varies depending on model and supply voltage as follows:

Table 2: Circuit-Breaker Amperage Ratings

	100V	120V	220V	240V
XLS 202	7A	7A	7A	7A
XLS 402	10A	10A	7A	7A
XLS 602	10A	10A	7A	7A

#### 4.1.4 Thermal Protection

The Thermal Protection circuit will activate if the internal heatsink temperature exceeds proper operating temperatures (194 °F, 90 °C). When the heatsink temperature has fallen to a safe level, this protection circuit will automatically be reset. Principle causes of thermal protection are:

- 1) Inadequate ventilation of the equipment rack
- 2) Incorrect load impedance
- 3) Output cable short circuit
- 4) Blocked air vent
- 5) Heatsinks in need of cleaning
- 6) Cooling fan failure.

The cause of your amplifier's thermal protection state should be determined and corrected as soon as possible. Without correction, the Thermal Protection circuit will typically reactivate.

## 5 Troubleshooting

CLIP 1	POWER	FAULT	CLIP 2	<p><b>CONDITION: Normal operation.</b></p> <p><b>POSSIBLE REASON:</b></p> <ul style="list-style-type: none"> <li>This is normal operation for your amp.</li> </ul>
--------	-------	-------	--------	--

CLIP 1	POWER	FAULT	CLIP 2	<p><b>CONDITION: No power to the amplifier.</b></p> <p><b>POSSIBLE REASON:</b></p> <ul style="list-style-type: none"> <li>The amplifier's Power switch is off.</li> <li>The amplifier is not plugged into the power receptacle.</li> <li>The amplifier's high-voltage power supply circuit breaker has tripped. Verify that the AC mains voltage is correct, then press the Circuit Breaker button on the back panel.</li> </ul>
--------	-------	-------	--------	--

CLIP 1	POWER	FAULT	CLIP 2	<p><b>CONDITION: Distorted sound.</b></p> <p><b>POSSIBLE REASON:</b></p> <ul style="list-style-type: none"> <li>Input signal level is too high. Turn down your amplifier Level controls. NOTE: Your amplifier should never be operated at a level which caused the Clip LEDs to illuminate constantly.</li> </ul>
CLIP 1	POWER	FAULT	CLIP 2	
CLIP 1	POWER	FAULT	CLIP 2	

CLIP 1	POWER	FAULT	CLIP 2	<p><b>CONDITION: No sound.</b></p> <p><b>POSSIBLE REASON:</b></p> <ul style="list-style-type: none"> <li>The amplifier has just turned on and is still in the 4-second turn-on delay.</li> <li>The amplifier is in "fault" mode. A Fault status can be triggered when one of the amplifier's protection circuits is activated. First disconnect your speakers from the affected channel(s) one by one to determine if one of the loads is shorted. If the indicators return to normal status, then try a different speaker or cable to determine where the short is occurring. If no short can be found, turn off the amp and allow the amp to cool. If indicators do not return to normal after restarting your amp, check the fuse and replace if necessary, or return amp to Crown or an authorized Crown Service Center for servicing.</li> </ul>
CLIP 1	POWER	FAULT	CLIP 2	
CLIP 1	POWER	FAULT	CLIP 2	
-----				
CLIP 1	POWER	FAULT	CLIP 2	<ul style="list-style-type: none"> <li>No input signal.</li> <li>Input signal level is very low.</li> <li>Level controls are turned down.</li> <li>Speakers not connected.</li> </ul>

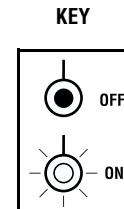



## 6 Specifications

Minimum Guaranteed Power	XLS 202	XLS 402	XLS 602
<b>120 VAC, 60 Hz Units, per channel, both channels driven</b>			
<b>1 kHz with 0.5% THD</b>			
Stereo, 2 ohms (per ch.)	250W	570W	840W
Stereo, 4 ohms (per ch.)	200W	400W	600W
Stereo, 8 ohms (per ch.)	145W	260W	370W
Bridge-Mono, 8 ohms	400W	800W	1,200W
Bridge-Mono, 4 ohms	500W	1,140W	1,680W
<b>240 VAC, 50 Hz Units, per channel, both channels driven</b>			
<b>1 kHz with 0.5% THD</b>			
Stereo, 2 ohms (per ch.)	250W	610W	880W
Stereo, 4 ohms (per ch.)	225W	445W	670W
Bridge-Mono, 4 ohms	500W	1,120W	1,760W
Performance	XLS 202	XLS 402	XLS 602
Sensitivity (volts RMS) for full rated power at 4 ohms	0.725	1.025	1.26
Frequency Response (at 1 watt, 22Hz - 20 kHz)	± 0.75 dB	± 0.75 dB	± 0.75 dB
Phase Response (at 1 watt, 10 Hz, 20 kHz)	-10°, +19°	-10°, +19°	-10°, +19°
Signal to Noise Ratio below rated power (20 Hz to 20 kHz)			
A-weighted, below rated power	> 100 dB	> 100 dB	> 100 dB
No weighting, below rated power	> 95 dB	> 95 dB	> 95 dB
Total Harmonic Distortion (THD) at 1 full bandwidth power, from 20 Hz to 1 kHz	< 0.5%	< 0.5%	< 0.5%
Intermodulation Distortion (IMD) 60 Hz and 7 kHz at 4:1, from full rated output to -40 dB	< 0.3%	< 0.3%	< 0.3%

## 6 Specifications

<b>Performance</b>	<b>XLS 202</b>	<b>XLS 402</b>	<b>XLS 602</b>
Damping Factor (8 ohm): 10 Hz to 400 Hz	> 200	> 200	> 200
Crosstalk (below rated power, at 1 kHz at 20 kHz)	-82 dB -58 dB	-82 dB -58 dB	-82 dB -58 dB
DC Output Offset (Shorted input)	± 10 mV	± 10 mV	± 10 mV
Input Impedance (nominally balanced, nominally unbalanced)	20 kilohms, 10 kilohms	20 kilohms, 10 kilohms	20 kilohms, 10 kilohms
Load Impedance (Note: Safe with all types of loads)			
Stereo	2-8 ohms	2-8 ohms	2-8 ohms
Bridge Mono	8 ohms	8 ohms	8 ohms
Voltage Gain (at maximum level setting)	31 dB	31 dB	31 dB
AC Line Voltage and Frequency Configurations Available (± 10%)	120 VAC/60 Hz and 230 VAC/50 Hz	120 VAC/60 Hz and 230 VAC/50 Hz	120 VAC/60 Hz and 230 VAC/50 Hz
<b>Construction</b>	<b>XLS 202</b>	<b>XLS 402</b>	<b>XLS 602</b>
Ventilation	Flow-through ventilation from front to back	Flow-through ventilation from front to back	Flow-through ventilation from front to back
Cooling	Internal heat sinks with forced-air cooling	Internal heat sinks with forced-air cooling	Internal heat sinks with forced-air cooling
Air Volume Requirements (per minute per unit)	80.15 ft <sup>3</sup> (2.27 m <sup>3</sup> )	80.15 ft <sup>3</sup> (2.27 m <sup>3</sup> )	80.15 ft <sup>3</sup> (2.27 m <sup>3</sup> )
Dimensions: Width, Height, Depth (behind mounting surface)	EIA Standard 19"W (EIA RS-310-B) x 3.5" (8.9 cm) H x 14" (35.6cm) D	EIA Standard 19"W (EIA RS-310-B) x 3.5" (8.9 cm) H x 14" (35.6cm) D	EIA Standard 19"W (EIA RS-310-B) x 3.5" (8.9 cm) H x 14" (35.6cm) D
Net Weight, Shipping Weight	21.0 lb (9.5 kg), 26.0 lb (11.8 kg)	25.3 lb (11.5 kg), 30.3 lb (13.8 kg)	27.2 lb (12.3 kg), 32.2 lb (14.6 kg)

## 7 AC Power Draw and Thermal Dissipation

This section provides detailed information about the amount of power and current drawn from the AC mains by XLS amplifiers and the amount of heat produced under various conditions. The calculations presented here are intended to provide a realistic and reliable depiction of the amplifiers. The following assumptions or approximations were made:

- The amplifier's available channels are loaded, and full power is being delivered.
- Efficiency at standard 1 kHz power into 4 ohms is 63% for the XLS 602, 57% for the XLS 402, and 49% for the XLS 202.
- Quiescent power draw is 26W for the XLS 602, 23W for the XLS 402, and 19W for the XLS 202.
- XLS 602 quiescent thermal dissipation equals 88 btu/hr at 0 watts with 4 and 8 ohm loads.
- The estimated duty cycles take into account the typical crest factor for each type of source material.
- Duty cycle of pink noise is 50%.
- Duty cycle of highly compressed rock 'n' roll midrange is 40%.
- Duty cycle of rock 'n' roll is 30%.
- Duty cycle of background music is 20%.
- Duty cycle of continuous speech is 10%.
- Duty cycle of infrequent, short duration paging is 1%.

Here are the equations used to calculate the data presented in Figures 7.1, 7.2 and 7.3:

$$\text{AC Mains Power Draw (watts)} = \frac{\text{Total output power with all channels driven (watts)} \times \text{Duty Cycle}}{\text{Amplifier Efficiency}} + \text{Quiescent and Fan Power Draw (watts)}$$

The following equation converts power draw in watts to current draw in amperes:

$$\text{Current Draw (amperes)} = \frac{\text{AC Mains Power Draw (watts)}}{\text{AC Mains Voltage} \times \text{Power Factor}}$$

The value used for Power Factor is 0.86 for the XLS 602, 0.85 for the XLS 402, and 0.87 for the XLS 202. The Power Factor variable is needed to compensate for the difference in phase between the AC mains voltage and current.

The following equation is used to calculate thermal dissipation:

$$\text{Thermal Dissipation (btu/hr)} = \left( \frac{\text{Total output power with all channels driven (watts)} \times \text{Duty Cycle} \times \text{Amplifier Inefficiency}}{\text{Amplifier Efficiency}} + \text{Quiescent and Fan Power Draw (watts)} \right) \times 3.415$$

The value used for amplifier inefficiency is (1.00-Efficiency). The factor 3.415 converts watts to btu/hr. Thermal dissipation in btu is divided by the constant 3.968 to get kcal.

If you plan to measure output power under real-world conditions, the following equation may also be helpful:

$$\text{Thermal Dissipation (btu/hr)} = \left( \frac{\text{Total measured output power from all channels (watts)} \times \text{Amplifier Inefficiency}}{\text{Amplifier Efficiency}} + \text{Quiescent and Fan Power Draw (watts)} \right) \times 3.415$$

## 7 AC Power Draw and Thermal Dissipation

### XLS 202

L O A D															
2 Ohm Stereo						4 Ohm Stereo					8 Ohm Stereo				
Duty Cycle	AC Mains Power Draw (W)	Current Draw (Amps)		Thermal Dissipation		AC Mains Power Draw (W)	Current Draw (Amps)		Thermal Dissipation		AC Mains Power Draw (W)	Current Draw (Amps)		Thermal Dissipation	
		120V	230V	btu/hr	kcal/hr		120V	230V	btu/hr	kcal/hr		120V	230V	btu/hr	kcal/hr
50%	529	5.1	2.6	953	240	427	4.1	2.1	776	196	315	3.0	1.6	580	146
40%	427	4.1	2.1	776	196	346	3.3	1.7	634	160	256	2.4	1.3	477	120
30%	325	3.1	1.6	598	151	264	2.5	1.3	491	124	197	1.9	1.0	374	94
20%	223	2.1	1.1	420	106	182	1.7	0.9	349	88	137	1.3	0.7	271	68
10%	121	1.2	0.6	243	61	101	1.0	0.5	207	52	78	0.7	0.4	168	42

Figure 7.1 XLS 202  
Power Draw, Current Draw and Thermal Dissipation at Various Duty Cycles

### XLS 402

L O A D															
2 Ohm Stereo						4 Ohm Stereo					8 Ohm Stereo				
Duty Cycle	AC Mains Power Draw (W)	Current Draw (Amps)		Thermal Dissipation		AC Mains Power Draw (W)	Current Draw (Amps)		Thermal Dissipation		AC Mains Power Draw (W)	Current Draw (Amps)		Thermal Dissipation	
		120V	230V	btu/hr	kcal/hr		120V	230V	btu/hr	kcal/hr		120V	230V	btu/hr	kcal/hr
50%	1023	10.0	5.2	1547	390	725	7.1	3.7	1109	279	479	4.7	2.5	748	189
40%	823	8.1	4.2	1253	316	584	5.7	3.0	903	228	388	3.8	2.0	614	155
30%	623	6.1	3.2	960	242	444	4.4	2.3	697	176	297	2.9	1.5	480	121
20%	423	4.1	2.2	666	168	304	3.0	1.6	491	124	205	2.0	1.1	346	87
10%	223	2.2	1.1	372	94	163	1.6	0.8	285	72	114	1.1	0.6	213	54

Figure 7.2 XLS 402  
Power Draw, Current Draw and Thermal Dissipation at Various Duty Cycles

## 7 AC Power Draw and Thermal Dissipation

### XLS 602

Duty Cycle	LOAD														
	2 Ohm Stereo					4 Ohm Stereo					8 Ohm Stereo				
	AC Mains Power Draw (W)	Current Draw (Amps)		Thermal Dissipation		AC Mains Power Draw (W)	Current Draw (Amps)		Thermal Dissipation		AC Mains Power Draw (W)	Current Draw (Amps)		Thermal Dissipation	
		120V	230V	btu/hr	kcal/hr		120V	230V	btu/hr	kcal/hr		120V	230V	btu/hr	kcal/hr
50%	1359	13.2	6.9	1774	447	978	9.5	5.0	1292	326	613	6.0	3.1	831	209
40%	1093	10.6	5.6	1437	362	788	7.7	4.0	1051	265	496	4.8	2.5	682	172
30%	826	8.1	4.2	1100	277	597	5.8	3.0	811	204	378	3.7	1.9	534	135
20%	559	5.5	2.8	763	192	407	4.0	2.1	570	144	261	2.5	1.3	386	97
10%	293	2.9	1.5	426	107	216	2.1	1.1	329	83	143	1.4	0.7	237	60

Figure 7.3 XLS 602  
Power Draw, Current Draw and Thermal Dissipation at Various Duty Cycles

## 8 Service

Crown amplifiers are quality units that rarely require servicing. Before returning your unit for servicing, please contact Crown Technical Support to verify the need for servicing.

This unit has very sophisticated circuitry which should only be serviced by a fully trained technician. This is one reason why each unit bears the following label:



**CAUTION: To prevent electric shock, do not remove covers. No user serviceable parts inside. Refer servicing to a qualified technician.**

### 8.1 Worldwide Service

Service may be obtained from an authorized service center. (Contact your local Crown/Amcron representative or our office for a list of authorized service centers.) To obtain service, simply present the bill of sale as proof of purchase along with the defective unit to an authorized service center. They will handle the necessary paperwork and repair.

Remember to transport your unit in the original factory pack.

### 8.2 US and Canada Service

Service may be obtained in one of two ways: from an authorized service center or from the factory. You may choose either. It is important that you have your copy of the bill of sale as your proof of purchase.

#### 8.2.1 Service at a US or Canada Service Center

This method usually saves the most time and effort. Simply present your bill of sale along with the defective unit to an authorized service center to obtain service. They will handle the necessary paperwork and repair. Remember to transport the unit in the original factory pack. A

list of authorized service centers in your area can be obtained from the Crown website at [www.crownaudio.com](http://www.crownaudio.com), or by calling Crown Customer Service.

### 8.2.2 Factory Service

To obtain factory service, fill out the service information page found in the back of this manual and send it along with your proof of purchase and the defective unit to the Crown factory.

For warranty service, we will pay for ground shipping both ways in the United States. Contact Crown Customer Service to obtain prepaid shipping labels prior to sending the unit. Or, if you prefer, you may prepay the cost of shipping, and Crown will reimburse you. Send copies of the shipping receipts to Crown to receive reimbursement.

Your repaired unit will be returned via UPS ground. Please contact us if other arrangements are required.

### 8.2.3 Factory Service Shipping Instructions:

1. Before sending a Crown product to the factory for service, first call the Crown Service Department for a return authorization (RA) number.
2. Be sure to fill out the service information form that follows and enclose it with your shipment, either inside the box or in a packing slip envelope securely attached to the outside of the shipping carton. Do not send the service information form separately. If you are sending the unit from a Shipping Center, we recommend taping the form to the product. We also recommend recording the serial number and model before shipping for your reference.

3. To ensure the safe transportation of your unit to the factory, ship it in an original factory packing container. If you don't have the original carton, you may obtain a product service foam-in-place shipping pack from the Crown Factory Service Department at the number listed below. For non-warranty service, you may also provide your own shipping pack, however we still recommend using a Crown Supplied Shipping Container. Minimum recommended requirements for materials are as follows: 275 P.S.I. burst test Double-Wall carton that allows for 2-inch solid Styrofoam on all six sides of unit or 3 inches of plastic bubble wrap on all six sides of unit; securely seal the package with an adequate carton sealing tape. Do not use light boxes or "peanuts." Damage caused by poor packing cannot be covered under warranty.
4. Do not ship the unit in any kind of cabinet (wood or metal). Ignoring this warning may result in extensive damage to the unit and the cabinet. Accessories are not needed—do not send the product documentation, cables and other hardware.

If you have any questions, please contact Crown Factory Service.

**Crown Factory Service**  
1718 W. Mishawaka Rd.,  
Elkhart, Indiana 46517 U.S.A.

**Telephone:** 574-294-8200  
800-342-6939 (North America,  
Puerto Rico, and Virgin Islands only)

**Facsimile:**  
574-294-8301 (Technical Support)  
574-294-8124 (Factory Service)

**Internet:**  
<http://www.crownaudio.com>

## 9 Warranty



### SUMMARY OF WARRANTY

Crown International, 1718 West Mishawaka Road, Elkhart, Indiana 46517-4095 U.S.A. warrants to you, the ORIGINAL PURCHASER and ANY SUBSEQUENT OWNER of each NEW Crown product, for a period of three (3) years from the date of purchase by the original purchaser (the "warranty period") that the new Crown product is free of defects in materials and workmanship. We further warrant the new Crown product regardless of the reason for failure, except as excluded in this Warranty.

### ITEMS EXCLUDED FROM THIS CROWN WARRANTY

This Crown Warranty is in effect only for failure of a new Crown product which occurred within the Warranty Period. It does not cover any product which has been damaged because of any intentional misuse, accident, negligence, or loss which is covered under any of your insurance contracts. This Crown Warranty also does not extend to the new Crown product if the serial number has been defaced, altered, or removed.

### WHAT THE WARRANTOR WILL DO

We will remedy any defect, regardless of the reason for failure (except as excluded), by repair, replacement, or refund. We may not elect refund unless you agree, or unless we are unable to provide replacement, and repair is not practical or cannot be timely made. If a refund is elected, then you must make the defective or malfunctioning product available to us free and clear of all liens or other encumbrances. The refund will be equal to the actual purchase price, not including inter-

## UNITED STATES & CANADA

est, insurance, closing costs, and other finance charges less a reasonable depreciation on the product from the date of original purchase. Warranty work can only be performed at our authorized service centers or at the factory. Warranty work for some products can only be performed at our factory. We will remedy the defect and ship the product from the service center or our factory within a reasonable time after receipt of the defective product at our authorized service center or our factory. All expenses in remedying the defect, including surface shipping costs in the United States, will be borne by us. (You must bear the expense of shipping the product between any foreign country and the port of entry in the United States including the return shipment, and all taxes, duties, and other customs fees for such foreign shipments.)

### HOW TO OBTAIN WARRANTY SERVICE

You must notify us of your need for warranty service within the warranty period. All components must be shipped in a factory pack, which, if needed, may be obtained from us free of charge. Corrective action will be taken within a reasonable time of the date of receipt of the defective product by us or our authorized service center. If the repairs made by us or our authorized service center are not satisfactory, notify us or our authorized service center immediately.

### DISCLAIMER OF CONSEQUENTIAL AND INCIDENTAL DAMAGES

YOU ARE NOT ENTITLED TO RECOVER FROM US ANY INCIDENTAL DAMAGES RESULTING

FROM ANY DEFECT IN THE NEW CROWN PRODUCT. THIS INCLUDES ANY DAMAGE TO ANOTHER PRODUCT OR PRODUCTS RESULTING FROM SUCH A DEFECT. SOME STATES DO NOT ALLOW THE EXCLUSION OR LIMITATIONS OF INCIDENTAL OR CONSEQUENTIAL DAMAGES, SO THE ABOVE LIMITATION OR EXCLUSION MAY NOT APPLY TO YOU.

### WARRANTY ALTERATIONS

No person has the authority to enlarge, amend, or modify this Crown Warranty. This Crown Warranty is not extended by the length of time which you are deprived of the use of the new Crown product. Repairs and replacement parts provided under the terms of this Crown Warranty shall carry only the unexpired portion of this Crown Warranty.

### DESIGN CHANGES

We reserve the right to change the design of any product from time to time without notice and with no obligation to make corresponding changes in products previously manufactured.

### LEGAL REMEDIES OF PURCHASER

THIS CROWN WARRANTY GIVES YOU SPECIFIC LEGAL RIGHTS, YOU MAY ALSO HAVE OTHER RIGHTS WHICH VARY FROM STATE TO STATE. No action to enforce this Crown Warranty shall be commenced after expiration of the warranty period.

THIS STATEMENT OF WARRANTY SUPERSEDES ANY OTHERS CONTAINED IN THIS MANUAL FOR CROWN PRODUCTS. 12/01

## 9 Warranty



### WORLDWIDE EXCEPT USA & CANADA

#### SUMMARY OF WARRANTY

Crown International, 1718 West Mishawaka Road, Elkhart, Indiana 46517-4095 U.S.A. warrants to you, the ORIGINAL PURCHASER and ANY SUBSEQUENT OWNER of each NEW Crown1 product, for a period of three (3) years from the date of purchase by the original purchaser (the "warranty period") that the new Crown product is free of defects in materials and workmanship, and we further warrant the new Crown product regardless of the reason for failure, except as excluded in this Warranty.

<sup>1</sup> Note: If your unit bears the name "Amcron," please substitute it for the name "Crown" in this warranty.

#### ITEMS EXCLUDED FROM THIS CROWN-WARRANTY

This Crown Warranty is in effect only for failure of a new Crown product which occurred within the Warranty Period. It does not cover any product which has been damaged because of any intentional misuse, accident, negligence, or loss which is covered under any of your insurance contracts. This Crown Warranty also does not extend to the new Crown product if the serial number has been defaced, altered, or removed.

#### WHAT THE WARRANTOR WILL DO

We will remedy any defect, regardless of the reason for failure (except as excluded), by repair, replacement, or refund. We may not elect refund unless you agree, or unless we are unable to provide replacement, and repair is not practical or cannot be timely made. If a refund is elected, then you must make the defective or malfunctioning product available to us free and clear of all liens or other encumbrances. The refund will be equal to the actual purchase price, not including interest, insurance, closing costs, and other finance charges less a reasonable depreciation on the product from the date of original purchase. Warranty work can only be performed at our authorized service centers. We will remedy the defect and ship the product from the service center within a reasonable time after receipt of the defective product at our authorized service center.

#### HOW TO OBTAIN WARRANTY SERVICE

You must notify your local Crown importer of your need for warranty service within the warranty period. All components must be shipped in the original box. Corrective action will be taken within a reasonable time of the date of receipt of the defective product by our authorized service center. If the repairs made by our authorized service center are not satisfactory, notify our authorized service center immediately.

#### DISCLAIMER OF CONSEQUENTIAL AND INCIDENTAL DAMAGES

YOU ARE NOT ENTITLED TO RECOVER FROM US ANY INCIDENTAL DAMAGES RESULTING FROM ANY DEFECT IN THE NEW CROWN PRODUCT. THIS INCLUDES ANY DAMAGE TO ANOTHER PRODUCT OR PRODUCTS RESULTING FROM SUCH A DEFECT.

#### WARRANTY ALTERATIONS

No person has the authority to enlarge, amend, or modify this Crown Warranty. This Crown Warranty is not extended by the length of time which you are deprived of the use of the new Crown product. Repairs and replacement parts provided under the terms of this Crown Warranty shall carry only the unexpired portion of this Crown Warranty.

#### DESIGN CHANGES

We reserve the right to change the design of any product from time to time without notice and with no obligation to make corresponding changes in products previously manufactured.

#### LEGAL REMEDIES OF PURCHASER

No action to enforce this Crown Warranty shall be commenced after expiration of the warranty period.

THIS STATEMENT OF WARRANTY SUPERSEDES ANY OTHERS CONTAINED IN THIS MANUAL FOR CROWN PRODUCTS. 7/01





### Crown Factory Service Information

Shipping Address: Crown Factory Service, 1718 W. Mishawaka Rd., Elkhart, IN 46517

Phone: 1-800-342-6939 or 1-574-294-8200 Fax: 1-574-294-8124

Owner's Name : \_\_\_\_\_

Shipping Address: \_\_\_\_\_

Phone Number: \_\_\_\_\_ Fax Number: \_\_\_\_\_ Email \_\_\_\_\_

Model: \_\_\_\_\_ Serial Number: \_\_\_\_\_

Purchase Date : \_\_\_\_\_

#### NATURE OF PROBLEM

*(Be sure to describe the conditions that existed when the problem occurred and what attempts were made to correct it.)*

\_\_\_\_\_  
\_\_\_\_\_  
\_\_\_\_\_  
\_\_\_\_\_  
\_\_\_\_\_  
\_\_\_\_\_  
\_\_\_\_\_  
\_\_\_\_\_

Other equipment in system: \_\_\_\_\_

\_\_\_\_\_  
\_\_\_\_\_

If warranty has expired, payment will be:  Cash/Check  Visa  Master Card  C.O.D.  Purchase Order for Crown Dealer

Card Number: \_\_\_\_\_ Exp. Date: \_\_\_\_\_

Signature: \_\_\_\_\_

ENCLOSE THIS PORTION WITH THE UNIT. DO NOT MAIL SEPARATELY.

THIS PAGE INTENTIONALLY LEFT BLANK

NOTES



**H** A Harman International Company