

1400 CSL

REFERENCE MANUAL

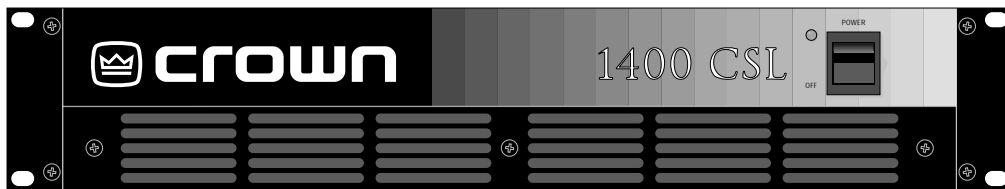

Model: 1400 CSL®

This model may be exported under the name *Amcron*®.

© 1999 by Crown International, Inc., P.O. Box 1000, Elkhart, IN 46515-1000 U.S.A. Telephone: 219-294-8000. Fax: 219-294-8329. The 1400 CSL amplifier is produced by the Professional Audio Division of Crown International, Inc. Trademark Notice: *Amcron*®, *Crown*®, *CSL*®, and *ODEP*® are registered trademarks of Crown International, Inc. Other trademarks are the property of their respective owners.



Approved for
THX® Theatre
Systems



THREE YEAR FULL WARRANTY



WORLDWIDE

NORTH AMERICA

SUMMARY OF WARRANTY

The Crown Audio Division of Crown International, Inc., 1718 West Mishawaka Road, Elkhart, Indiana 46517-4095 U.S.A. warrants to you, the ORIGINAL PURCHASER and ANY SUBSEQUENT OWNER of each NEW Crown¹ product, for a period of three (3) years from the date of purchase by the original purchaser (the "warranty period") that the new Crown product is free of defects in materials and workmanship, and we further warrant the new Crown product regardless of the reason for failure, except as excluded in this Crown Warranty.

¹ Note: If your unit bears the name "Amcron," please substitute it for the name "Crown" in this warranty.

ITEMS EXCLUDED FROM THIS CROWN WARRANTY

This Crown Warranty is in effect only for failure of a new Crown product which occurred within the Warranty Period. It does not cover any product which has been damaged because of any intentional misuse, accident, negligence, or loss which is covered under any of your insurance contracts. This Crown Warranty also does not extend to the new Crown product if the serial number has been defaced, altered, or removed.

WHAT THE WARRANTOR WILL DO

We will remedy any defect, regardless of the reason for failure (except as excluded), by repair, replacement, or refund. We may not elect refund unless you agree, or unless we are unable to provide replacement, and repair is not practical or cannot be timely made. If a refund is elected, then you must make the defective or malfunctioning product available to us free and clear of all liens or other encumbrances. The refund will be equal to the actual purchase price, not including interest, insurance, closing costs, and other finance charges less a reasonable depreciation on the product from the date of original purchase. Warranty work can only be performed at our authorized service centers. We will remedy the defect and ship the product from the service center within a reasonable time after receipt of the defective product at our authorized service center.

HOW TO OBTAIN WARRANTY SERVICE

You must notify us of your need for warranty service not later than ninety (90) days after expiration of the warranty period. All components must be shipped in a factory pack. Corrective action will be taken within a reasonable time of the date of receipt of the defective product by our authorized service center. If the repairs made by our authorized service center are not satisfactory, notify our authorized service center immediately.

DISCLAIMER OF CONSEQUENTIAL AND INCIDENTAL DAMAGES
YOU ARE NOT ENTITLED TO RECOVER FROM US ANY INCIDENTAL DAMAGES RESULTING FROM ANY DEFECT IN THE NEW CROWN PRODUCT. THIS INCLUDES ANY DAMAGE TO ANOTHER PRODUCT OR PRODUCTS RESULTING FROM SUCH A DEFECT.

WARRANTY ALTERATIONS

No person has the authority to enlarge, amend, or modify this Crown Warranty. This Crown Warranty is not extended by the length of time which you are deprived of the use of the new Crown product. Repairs and replacement parts provided under the terms of this Crown Warranty shall carry only the unexpired portion of this Crown Warranty.

DESIGN CHANGES

We reserve the right to change the design of any product from time to time without notice and with no obligation to make corresponding changes in products previously manufactured.

LEGAL REMEDIES OF PURCHASER

No action to enforce this Crown Warranty shall be commenced later than ninety (90) days after expiration of the warranty period.

THIS STATEMENT OF WARRANTY SUPERSEDES ANY OTHERS CONTAINED IN THIS MANUAL FOR CROWN PRODUCTS.

9/90

Telephone: 219-294-8200. Facsimile: 219-294-8301

SUMMARY OF WARRANTY

The Crown Audio Division of Crown International, Inc., 1718 West Mishawaka Road, Elkhart, Indiana 46517-4095 U.S.A. warrants to you, the ORIGINAL PURCHASER and ANY SUBSEQUENT OWNER of each NEW Crown product, for a period of three (3) years from the date of purchase by the original purchaser (the "warranty period") that the new Crown product is free of defects in materials and workmanship. We further warrant the new Crown product regardless of the reason for failure, except as excluded in this Warranty.

ITEMS EXCLUDED FROM THIS CROWN WARRANTY

This Crown Warranty is in effect only for failure of a new Crown product which occurred within the Warranty Period. It does not cover any product which has been damaged because of any intentional misuse, accident, negligence, or loss which is covered under any of your insurance contracts. This Crown Warranty also does not extend to the new Crown product if the serial number has been defaced, altered, or removed.

WHAT THE WARRANTOR WILL DO

We will remedy any defect, regardless of the reason for failure (except as excluded), by repair, replacement, or refund. We may not elect refund unless you agree, or unless we are unable to provide replacement, and repair is not practical or cannot be timely made. If a refund is elected, then you must make the defective or malfunctioning product available to us free and clear of all liens or other encumbrances. The refund will be equal to the actual purchase price, not including interest, insurance, closing costs, and other finance charges less a reasonable depreciation on the product from the date of original purchase. Warranty work can only be performed at our authorized service centers or at the factory. We will remedy the defect and ship the product from the service center or our factory within a reasonable time after receipt of the defective product at our authorized service center or our factory. All expenses in remedying the defect, including surface shipping costs in the United States, will be borne by us. (You must bear the expense of shipping the product between any foreign country and the port of entry in the United States and all taxes, duties, and other customs fees for such foreign shipments.)

HOW TO OBTAIN WARRANTY SERVICE

You must notify us of your need for warranty service not later than ninety (90) days after expiration of the warranty period. All components must be shipped in a factory pack, which, if needed, may be obtained from us free of charge. Corrective action will be taken within a reasonable time of the date of receipt of the defective product by us or our authorized service center. If the repairs made by us or our authorized service center are not satisfactory, notify us or our authorized service center immediately.

DISCLAIMER OF CONSEQUENTIAL AND INCIDENTAL DAMAGES
YOU ARE NOT ENTITLED TO RECOVER FROM US ANY INCIDENTAL DAMAGES RESULTING FROM ANY DEFECT IN THE NEW CROWN PRODUCT. THIS INCLUDES ANY DAMAGE TO ANOTHER PRODUCT OR PRODUCTS RESULTING FROM SUCH A DEFECT. **SOME STATES DO NOT ALLOW THE EXCLUSION OR LIMITATIONS OF INCIDENTAL OR CONSEQUENTIAL DAMAGES, SO THE ABOVE LIMITATION OR EXCLUSION MAY NOT APPLY TO YOU.**

WARRANTY ALTERATIONS

No person has the authority to enlarge, amend, or modify this Crown Warranty. This Crown Warranty is not extended by the length of time which you are deprived of the use of the new Crown product. Repairs and replacement parts provided under the terms of this Crown Warranty shall carry only the unexpired portion of this Crown Warranty.

DESIGN CHANGES

We reserve the right to change the design of any product from time to time without notice and with no obligation to make corresponding changes in products previously manufactured.

LEGAL REMEDIES OF PURCHASER

THIS CROWN WARRANTY GIVES YOU SPECIFIC LEGAL RIGHTS, YOU MAY ALSO HAVE OTHER RIGHTS WHICH VARY FROM STATE TO STATE. No action to enforce this Crown Warranty shall be commenced later than ninety (90) days after expiration of the warranty period.

THIS STATEMENT OF WARRANTY SUPERSEDES ANY OTHERS CONTAINED IN THIS MANUAL FOR CROWN PRODUCTS.

Telephone: 219-294-8200. Facsimile: 219-294-8301

9/90

Important Safety Instructions

- 1) Read these instructions.
- 2) Keep these instructions.
- 3) Heed all warnings.
- 4) Follow all instructions.
- 5) Do not use this apparatus near water.
- 6) Clean only with a dry cloth.
- 7) Do not block any ventilation openings. Install in accordance with the manufacturer's instructions.
- 8) Do not install near any heat sources such as radiators, heat registers, stoves, or other apparatus that produce heat.
- 9) Do not defeat the safety purpose of the polarized or grounding-type plug. A polarized plug has two blades with one wider than the other. A grounding-type plug has two blades and a third grounding prong. The wide blade or the third prong is provided for your safety. If the provided plug does not fit into your outlet, consult an electrician for replacement of the obsolete outlet.
- 10) Protect the power cord from being walked on or pinched, particularly at plugs, convenience receptacles, and the point where they exit from the apparatus.
- 11) Only use attachments/accessories specified by the manufacturer.
- 12) Use only with a cart, stand, bracket, or table specified by the manufacturer, or sold with the apparatus. When a cart is used, use caution when moving the cart/apparatus combination to avoid injury from tip-over.
- 13) Unplug this apparatus during lightning storms or when unused for long periods of time.
- 14) Refer all servicing to qualified service personnel. Servicing is required when the apparatus has been damaged in any way, such as power-supply cord or plug is damaged, liquid has been spilled or objects have fallen into the apparatus, the apparatus has been exposed to rain or moisture, does not operate normally, or has been dropped.

The information furnished in this manual does not include all of the details of design, production, or variations of the equipment. Nor does it cover every possible situation which may arise during installation, operation or maintenance. If your unit bears the name "Amcron," please substitute it for the name "Crown" in this manual. If you need special assistance beyond the scope of this manual, please contact our Technical Support Group.

Crown Audio Division Technical Support Group

Plant 2 SW, 1718 W. Mishawaka Rd., Elkhart, Indiana 46517 U.S.A.
 Phone: **800-342-6939** (North America, Puerto Rico and Virgin Islands) or 219-294-8200
 Fax: 219-294-8301 Fax Back (North America only): 800-294-4094 or 219-293-9200
 Fax Back (International): 219-294-8100 Internet: <http://www.crownaudio.com>

<div style="border: 1px solid black; padding: 5px; text-align: center; margin-bottom: 10px;"> <p>CAUTION</p> <p>RISK OF ELECTRIC SHOCK DO NOT OPEN</p> </div> <p>TO PREVENT ELECTRIC SHOCK DO NOT REMOVE TOP OR BOTTOM COVERS. NO USER SERVICEABLE PARTS INSIDE. REFER SERVICING TO QUALIFIED SERVICE PERSONNEL. DISCONNECT POWER CORD BEFORE REMOVING BACK PANEL COVER TO ACCESS GAIN SWITCH.</p>	<div style="border: 1px solid black; padding: 5px; text-align: center; margin-bottom: 10px;"> <p>AVIS</p> <p>RISQUE DE CHOC ÉLECTRIQUE N'OUVREZ PAS</p> </div> <p>À PRÉVENIR LE CHOC ÉLECTRIQUE N'ENLEVEZ PAS LES COUVERCLES. IL N'Y A PAS DES PARTIES SERVICEABLE À L'INTÉRIEUR. TOUS REPARATIONS DOIT ETRE FAIRE PAR PERSONNEL QUALIFIÉ SEULMENT. DÉBRANCHER LA BORNE AVANT D'ENLEVER LA COVERTURE EN ARRIÈRE.</p>
---	---



WARNING

TO REDUCE THE RISK OF ELECTRIC SHOCK, DO NOT EXPOSE THIS EQUIPMENT TO RAIN OR MOISTURE!

Magnetic Field

CAUTION! Do not locate sensitive high-gain equipment such as preamplifiers or tape decks directly above or below the unit. Because this amplifier has a high power density, it has a strong magnetic field which can induce hum into unshielded devices that are located nearby. The field is strongest just above and below the unit.

If an equipment rack is used, we recommend locating the amplifier(s) in the bottom of the rack and the preamplifier or other sensitive equipment at the top.



The lightning bolt triangle is used to alert the user to the risk of electric shock.



The exclamation point triangle is used to alert the user to important operating or maintenance instructions.



CONTENTS

1 Welcome	7
1.1 Unpacking	7
1.2 Features	7
2 Installation	8
2.1 Stereo	8
2.2 Mono	8
2.3 Input Sensitivity Adjustment	10
2.4 Additional Load Protection	10
3 Operation	11
3.1 Precautions	11
3.2 Indicators	11
3.3 Protection Systems	11
3.3.1 ODEP	11
3.3.2 Ultrasonic and RF Protection	11
3.3.3 Drive Protection	11
3.3.4 Transformer Thermal Protection	11
3.3.5 Fuses and Circuit Breakers	12
3.4 Controls	12
3.5 Filter Cleaning	12
4 Specifications	13
5 Accessories	17
5.1 MT-XLR	17
5.2 MT-BB	17
6 Service	18
6.1 Worldwide Service	18
6.2 North American Service	18
6.2.1 Service at a N. American Service Center ..	18
6.2.2 Factory Service	18

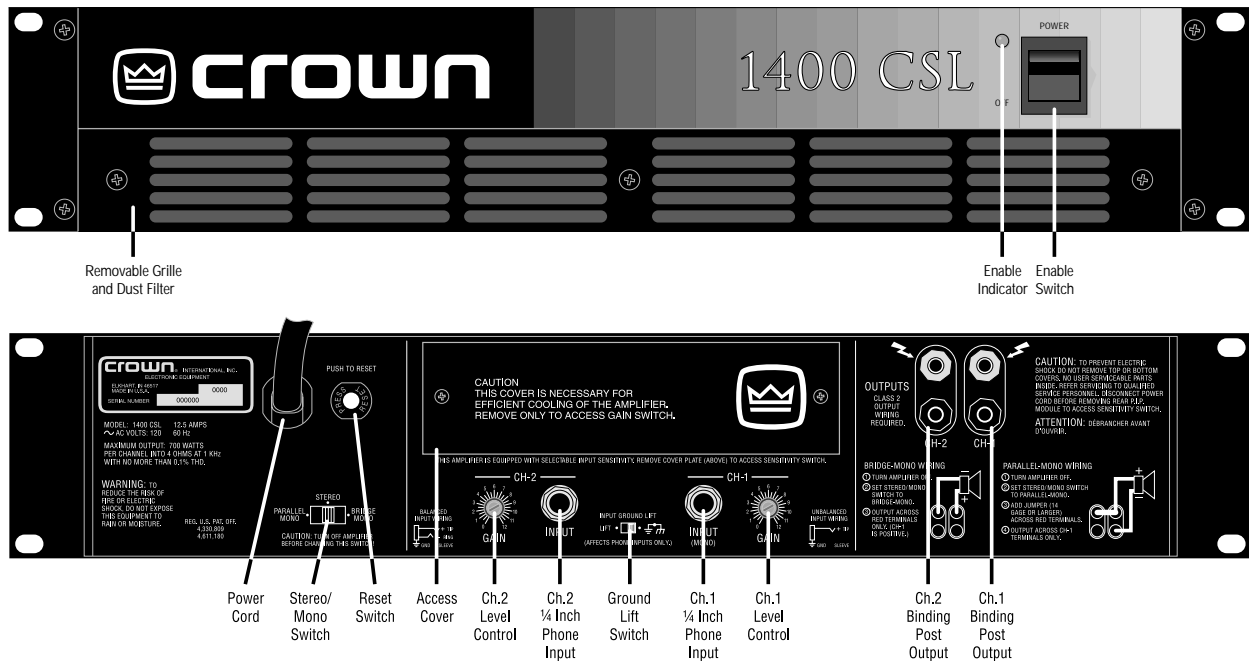
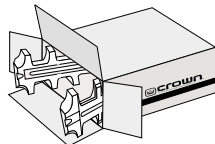

Fig. 1.1 1400 CSL Front and Back Panels

1 Welcome

Congratulations on your purchase of a Crown® 1400 CSL® amplifier. The 1400 CSL amplifier is a compact, professional stereo power amplifier engineered to meet the most demanding sound reinforcement needs. It compares very favorably to more expensive amplifiers, providing uncolored sound and a signal-to-noise ratio more commonly associated with recording studios.

This manual will help you successfully install and use your amplifier—we strongly recommend you read all instructions, warnings and cautions. If you plan to operate in one of the two mono modes, be sure to read the Mono section. Also for your protection, please save your bill of sale as it is your official proof of purchase.



1.1 Unpacking

Please unpack and inspect your new amplifier for any damage that may have occurred during transit. If damage is found, notify the transportation company immediately. Only you may initiate a claim with the carrier for damage resulting during shipment. Even if the unit arrived in perfect condition, as most do, save all packing materials so you will have them if you ever need to transport the unit. NEVER SHIP THE UNIT WITHOUT THE FACTORY PACK.

1.2 Features

- ❑ Rugged, professional power amplifier mounts in a standard 19-inch (48.3-cm) equipment rack.
- ❑ Front panel power switch with turn-on delay for loudspeaker protection.
- ❑ Full, uncolored power with any reasonable load.
- ❑ Patented Output Device Emulation Protection (ODEP®) keeps the amplifier working when others would fail.
- ❑ High damping factor provides superior control over low-frequency drivers for a clean, accurate low end.
- ❑ Safe with any load. Bridge-Mono and Parallel-Mono modes offer optimal load-matching performance.
- ❑ Complete protection against shorted outputs, mismatched loads, overheating, DC, input/output and high-frequency overload; full internal fault protection.
- ❑ Balanced phone jack inputs with internal three-position sensitivity switch. Optional XLR or barrier block input connectors are available with the *MT-XLR* and *MT-BB* accessories.
- ❑ Ground lift switch helps prevent “ground loops” by isolating the chassis from the phone input grounds.
- ❑ Efficient heat sinks and self-contained forced air cooling system dissipate heat quickly and evenly for extra amplifier protection and greater power output.
- ❑ Three year “No-Fault” full warranty and guaranteed specifications protect your investment.

2 Installation

Always remove power from the unit and turn the level controls off when making connections. This reduces the chance of loudspeaker damage from loud blasts.

Follow the guidelines listed next as well as the steps required for the specific mode of operation:

1. Install the amplifier in a standard 19-inch (48.3-cm) rack or place it on a stable surface. The mounting dimensions are 19 inches (48.3 cm) wide, 3.5 inches (8.9 cm) tall and 16 inches (40.6 cm) deep behind the mounting surface. **IMPORTANT! Allow for adequate ventilation.**

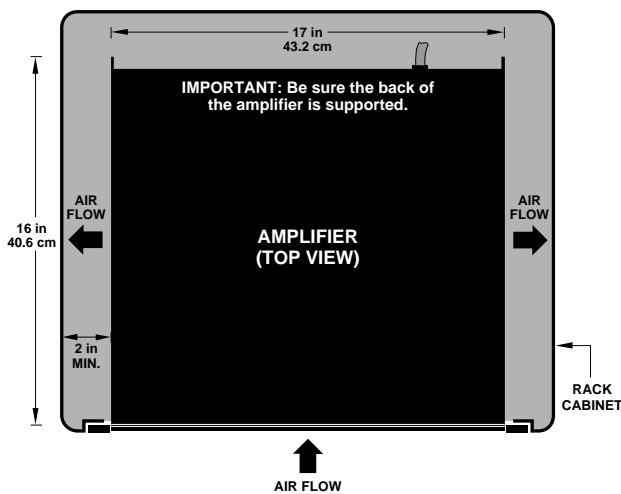

Fig. 2.1 Do NOT Block Air Flow

2. Use high-quality loudspeaker cables to connect the load to the amplifier's output jacks. Do not use shielded cable. Banana plugs are recommended for this connection.
3. Use shielded cables to connect audio sources to the amplifier inputs. Either balanced or unbalanced wiring can be used as shown below. (XLR connectors are available with the *MT-XLR* accessory. See Section 5.)

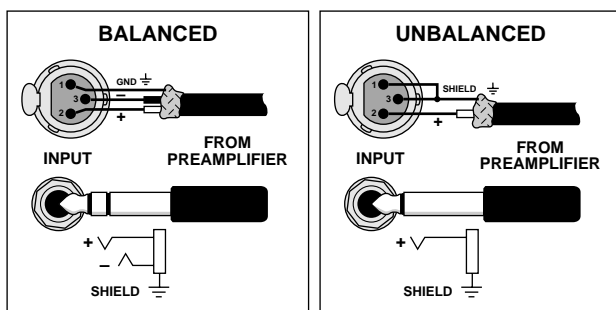



Fig. 2.2 CSL Input Wiring

4. An appropriate AC cord and plug are provided. Use an isolated wall outlet with the correct voltage and adequate current. Voltages more than 10% over the amplifier's rated voltage may damage the ± 15 -volt regulator, filter capacitors and output transistors.

2.1 Stereo

1. Turn the level controls down (fully counterclockwise) and turn off the amplifier.
2. Set the back panel stereo/mono switch to Stereo.
3. If present, remove the Parallel-Mono jumper.
4. Connect the input and output cables as shown in the first example in Figure 2.3.
5. Turn on the amplifier and adjust the level for each channel with the back panel level controls.

CAUTION: In Stereo mode, never parallel the two outputs by directly tying them together, and never parallel them with the output of another amplifier. 

2.2 Mono

The monaural operating modes provide twice the power to one channel as the Stereo mode. In Bridge-Mono mode, the outputs are wired in series for twice the output voltage. In Parallel-Mono mode, the outputs are paralleled for twice the current capacity.

Bridge-Mono mode is provided for loads with an impedance greater than 4 ohms. Parallel-Mono mode should be used with loads of 4 ohms or less.

BRIDGE-MONO

1. Turn the level controls down (fully counterclockwise) and turn off the amplifier.
2. Set the back panel stereo/mono switch to Bridge-Mono.
3. If present, remove the Parallel-Mono jumper.
4. Connect the input and output cables as shown in the second example in Figure 2.3. **Use the Ch.1 input only.**
5. Make sure the load is balanced (neither side shorted to ground) and do not use the black (-) banana jacks.
6. Turn on the amplifier and adjust the level. **Use the Ch.1 level control only.**

PARALLEL-MONO

1. Turn down the level controls (fully counterclockwise) and turn off the amplifier.
2. Set the back panel stereo/mono switch to Parallel-Mono.
3. Install a solid jumper (at least 14 gauge) across the output between the two red (+) banana jacks.
4. Connect the input and output cables as shown in the third example in Figure 2.3. **Use the Ch.1 input only.**
5. Turn on the amplifier and adjust the level. **Use the Ch.1 level control only.**

CAUTION: When wired for Parallel-Mono mode, do not attempt to operate the amplifier in Stereo or Bridge-Mono mode until the output jumper is removed. Failure to do so will result in inefficient operation, distortion and excessive heating. 

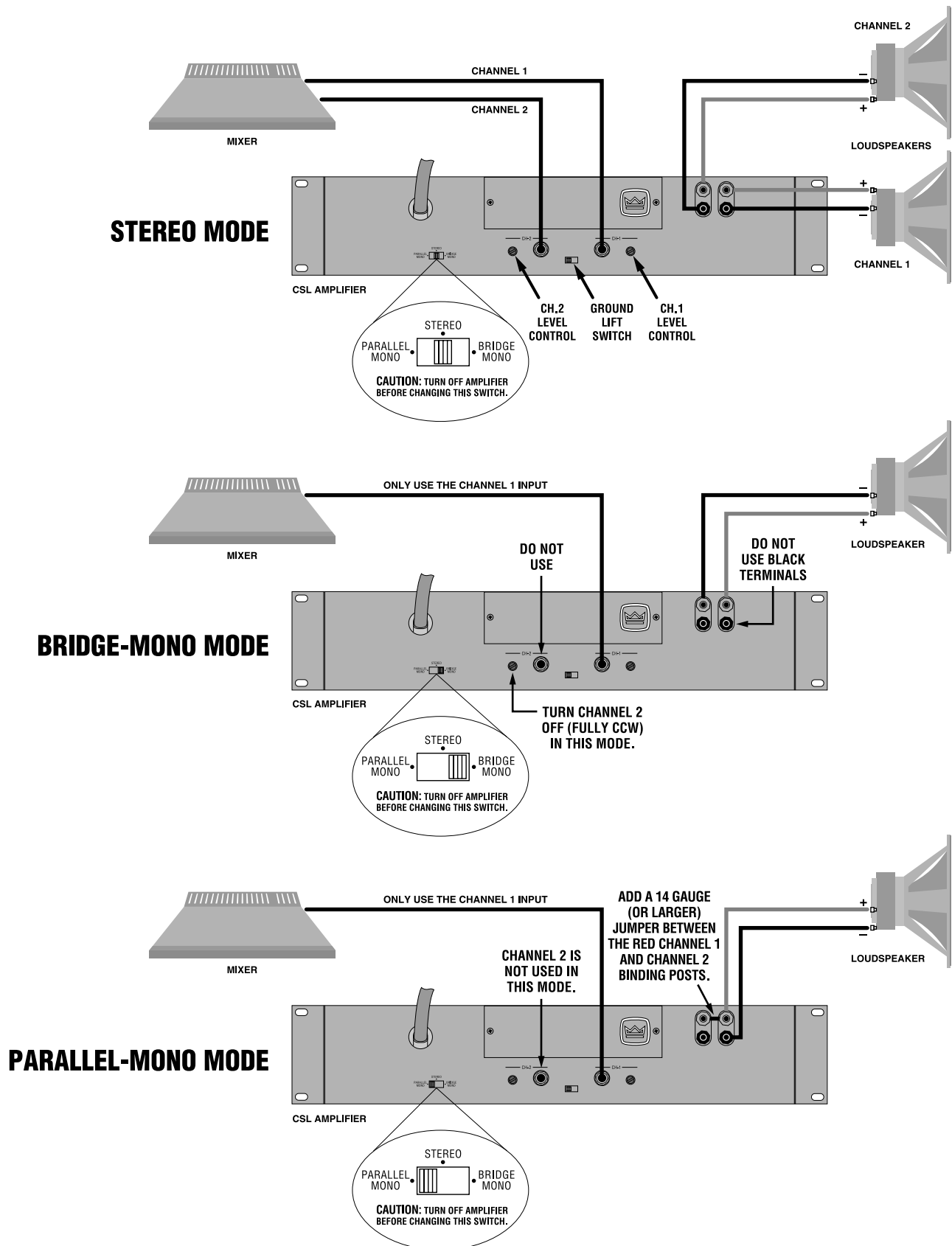

Fig. 2.3 Three System Connection Methods

2.3 Input Sensitivity Adjustment

The input sensitivity switch inside the amplifier is set to 0.775 volts at the factory. It can be changed to 1.4 volts or a voltage gain of 26 dB as follows:

1. Turn off and unplug the amplifier from the AC source.
2. Remove the access cover on the back panel.
3. Locate the labeled access hole for the sensitivity switch.
4. Set the switch to the desired position.
5. Replace the access cover plate.

When set to 26 dB gain, the 1400 CSL requires a 3.2-volt input to deliver full output into an 8-ohm load.

2.4 Additional Load Protection

Because *the* CSL amplifier can generate enormous power, it may be desirable to protect loudspeakers from damage due to excessive power. A common way to do this is to put a fuse in series with the load. This may be accomplished with a single fuse to protect the entire system, or by fusing each driver separately. Use Figure 2.4 to find the correct fuse.

Example: (A) Choose the peak music power for the loudspeaker (such as 75 watts). (B) Find the loudspeaker impedance (8 ohms). (C) Draw a line between points A and B. The line intersects the middle scale at the correct fuse value (1.5 amps).

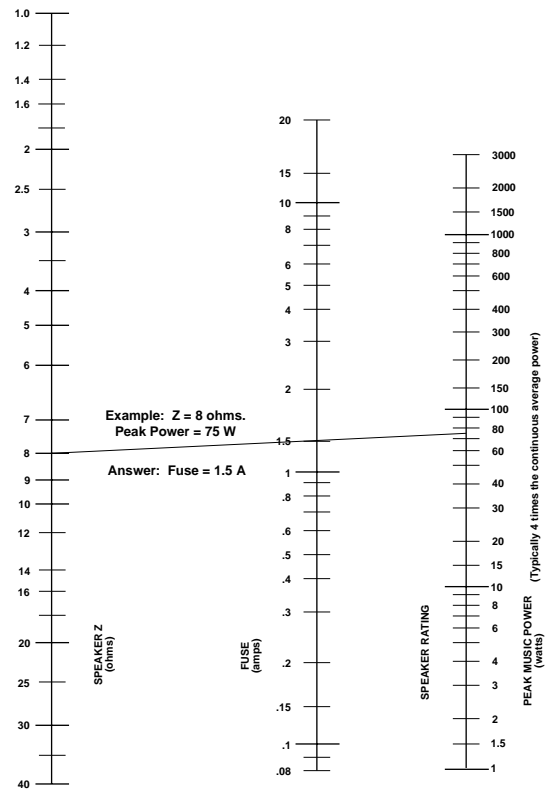

Fig. 2.4 Loudspeaker Fuse Nomograph

3 Operation

3.1 Precautions

Although your amplifier is protected from external faults, the following safety precautions are recommended:

1. There are important differences among the Stereo, Bridge-Mono and Parallel-Mono operating modes. Refer to Sections 2.1 and 2.2.



2. **WARNING: Do not change the stereo/mono switch unless the amplifier is first turned off.**



3. **CAUTION: In Parallel-Mono mode, a jumper is installed between the red output posts. Be sure to remove this jumper for Bridge-Mono or Stereo mode, otherwise inefficient operation, high distortion and excessive heating will occur.** Also, check the stereo/mono switch for proper position.

4. Use care when making connections, selecting signal sources and controlling the output level.
5. Do not short the ground lead of an output cable to the input signal ground. This may form a ground loop and cause oscillations.
6. Operate the amplifier from AC mains of not more than 10% variation above or below the selected line voltage and only at the specified line frequency.
7. Never connect the output to a power supply output, battery or power main.
8. Circuit tampering by unqualified personnel, or making unauthorized circuit changes voids the warranty.

Remember: Crown is not liable for any damage that results from overdriving other system components.

3.2 Indicators

When lit, the amber LED shows that the unit is turned on, and the low-voltage power supply is working. It does not show the status of the high-voltage supplies.

3.3 Protection Systems

The CSL amplifier has extensive protection systems, including *ODEP*, ultrasonic/RF protection, drive protection, transformer thermal protection fuses, and circuit breakers that protect the power supplies.

3.3.1 *ODEP*

Crown invented *ODEP* to prevent amplifier shutdown during demanding operation and to increase the efficiency of the output circuitry. To do this, Crown established a rigorous program to measure the *safe*

operating area (SOA) of each output transistor. Then, Crown designed intelligent circuitry to simulate instantaneous transistor conditions. Its name describes what it does: Output Device Emulation Protection, or *ODEP*. In essence, *ODEP* compares transistor conditions to their known SOA. If more power will be asked of them than they can deliver with the present conditions, *ODEP* limits the drive until conditions fall within the SOA. Limiting is proportional and kept to an absolute minimum—only what is required to prevent output transistor damage. Under normal conditions, no limiting is required and *ODEP* is transparent to the audio signal.

ODEP makes possible a quantum leap in output efficiency and reliability—with *ODEP*, the show goes on.

3.3.2 Ultrasonic and Radio Frequency (RF) Protection

Your CSL amplifier has a controlled slew rate. This means that its design limits the frequencies that they can reproduce. The limiting occurs far above audible frequencies (20 Hz to 20 kHz), but it protects sensitive loads like tweeters from ultrasonic and radio frequencies. An amplifier's slew rate only needs to be large enough to deliver the maximum voltage at the highest required frequency—higher slew rates actually allow undesirable frequencies to be reproduced.

3.3.3 Drive Protection

The drive protection system temporarily removes output drive to protect the amplifier and its loads. Drive protection can be activated in two situations. First, if dangerous subsonic frequencies or direct current (DC) is detected in the amplifier's output, the unit will activate its DC/low-frequency protection circuitry which also activates drive protection mode. This protects the loads and prevents oscillations. The unit resumes normal operation as soon as dangerous output is no longer detected. Although it is extremely unlikely that you will ever activate the DC/low-frequency protection system, improper source materials like subsonic square waves or input overloads that excessively clip the input signal can activate this system.

The amplifier's fault protection system will activate drive protection mode in rare situations where the output devices see heavy common-mode current. The output devices should never see heavy common-mode current unless the circuitry is damaged. Activating drive protection helps prevent further damage.

3.3.4 Transformer Thermal Protection

Your CSL amplifier has transformer thermal protection.

This protection circuitry is activated in unusual situations where the unit's transformer temperature rises to unsafe levels. Under these abnormal conditions, the unit removes power to the high-voltage transformer (the fan will also run in 120 VAC, 60 Hz units). The amplifier will return to normal after it cools to a safe temperature.

It is very unlikely that you will ever see a *CSL* amplifier activate transformer thermal protection as long as it is operated within rated conditions. The amplifier is designed to keep working under conditions where other amplifiers would fail. But even when the limits of a *CSL* are exceeded, it still protects itself—and your investment—from damage.

3.3.5 Fuses and Circuit Breakers

The power supplies for the *1400 CSL* are protected by a circuit breaker. With rated loads and output levels, the circuit breaker should only shut down the amplifier in the incredibly rare instance of a catastrophic amplifier failure. Other protection systems such as *ODEP* keep the amplifier operational under most other severe conditions. The breaker can also shut down the amplifier in situations where extremely low-impedance loads and high output levels result in current draw that exceeds its rating. Again, this should only be possible when *operating outside rated conditions*, such as driving a 1-ohm load or overloading the input and creating a severely clipped signal.

In addition to the breaker, your unit has a separate fuse for the low-voltage power supply and cooling fan.

An amplifier will not blow its fuse (or breaker) unless something is wrong. In the rare event that an internal fuse blows, please refer the unit to a qualified technician. If the breaker in your amplifier trips, try to identify and correct the problem before resetting the breaker with the back panel reset switch. If the problem persists, refer the unit to a qualified technician.

3.4 Controls

The enable switch is located on the front panel so you can easily turn the amplifier on and off. When making

any setup or wiring changes, don't forget to turn off the amplifier, turn down the level controls and disconnect the power cord. The back panel **stereo/mono switch** is used to select Stereo, Bridge-Mono or Parallel-Mono operating modes (see Sections 2.1 and 2.2). The **level controls** are also located on the back panel. Be sure to leave channel 2 turned down when using Bridge-Mono mode. The back panel **ground lift switch** isolates the phone jack input grounds from the chassis ground to help prevent ground loops. It does not affect any installed input accessories. The **input sensitivity switch** is located inside the back cover plate. It is used to set the amplifier's input sensitivity (see Section 2.3). The *1400 CSL* has a back panel **reset switch** that is used to reset the breaker that protects the amplifier's power supplies (see Section 3.3.5).

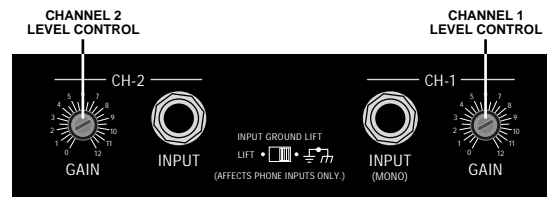

Fig. 3.1 Back Panel Level Controls

3.5 Filter Cleaning

A dust filter is provided on the unit's air intake. If it becomes clogged, the unit will cool less efficiently and may produce lower output levels. To clean, remove the three phillips screws that secure the front grille. Use mild dishwashing detergent and warm water for best results. New filters may be ordered from the factory.

Dust filters are not 100% efficient—depending on the local environment, the internal heat sinks of the amplifier will benefit from periodic cleaning by a qualified technician. Internal cleaning information is available from our Technical Support Group.

4 Specifications

The following applies to units in Stereo mode with 8-ohm loads and an input sensitivity of 26 dB unless otherwise specified.

Standard 1 kHz Power: refers to maximum average power in watts at 1 kHz with 0.1% THD.

Full Bandwidth Power: refers to maximum average power in watts from 20 Hz to 20 kHz with 0.1% THD.

120 VAC, 60 Hz Units: refers to amplifiers with dedicated transformers for 120 VAC, 60 Hz power mains.

International Units: refers to amplifiers with special multi-tap transformers that make them configurable for several AC mains voltages and line frequencies.

Performance

Frequency Response: ± 0.1 dB from 20 Hz to 20 kHz at 1 watt.

Phase Response: ± 10 degrees from 10 Hz to 20 kHz at 1 watt.

Signal-to-Noise Ratio: A-weighted, better than 105 dB below full bandwidth power. No weighting, better than 100 dB below full bandwidth power.

Total Harmonic Distortion (THD): Less than 0.05% at full bandwidth power from 20 Hz to 1 kHz increasing linearly to 0.1% at 20 kHz.

Intermodulation Distortion (IMD): (60 Hz and 7 kHz) Less than 0.05% from less than 158 milliwatts to full bandwidth power.

Damping Factor: Greater than 1,000 from 10 Hz to 400 Hz.

Crosstalk: Greater than 90 dB below full bandwidth power from 50 Hz to 4 kHz, rising linearly to greater than 70 dB at 20 kHz.

Slew Rate: Greater than 13 volts per microsecond.

Voltage Gain: 20:1 $\pm 3\%$ or 26 dB ± 0.25 dB at the maximum level setting; 83:1 $\pm 12\%$ or 38.4 dB ± 1 dB at 0.775 volt sensitivity; 46:1 $\pm 12\%$ or 33.3 dB ± 1 dB at 1.4 volt sensitivity.

Power

Output Power: *The following specifications are guaranteed minimums for standard 1 kHz power from 120 VAC, 60 Hz North American units. For additional information and power specifications for international units, see the power matrices on the pages that follow.*

Stereo mode (both channels driven):

700 watts into 4 ohms.

500 watts into 8 ohms.

Bridge-Mono mode:

1,500 watts into 8 ohms.

1,075 watts into 16 ohms.

Parallel-Mono mode:

1,515 watts into 2 ohms.

1,050 watts into 4 ohms.

Load Impedance: Safe with all types of loads. Rated for 4 to 8 ohms in Stereo, 8 to 16 ohms in Bridge-Mono and 2 to 4 ohms in Parallel-Mono mode.

Required AC Mains: 50 to 60 Hz; 100, 120, 220, 230 and 240 VAC ($\pm 10\%$) units are available. All draw 90 watts or less at idle. Current, frequency and voltage requirements are provided on each unit's back panel.

100 and 120 VAC units draw up to 15 amps of current; 220 and 240 VAC units draw up to 7 amps.

Sufficient AC power must be provided to the amplifier. Amplifiers cannot create energy—they require proper voltage and current to deliver the power you expect.

Low-Voltage Power Supply: A ± 24 VDC fanformer supply (fan motor winding) regulated to ± 15 VDC.

AC Connector: An appropriate AC line cord and plug are provided. North American units have a standard 3-wire, 15 amp grounded connector (NEMA 5-15P).

Controls

Enable: A front panel rocker switch used to turn the amplifier on and off.

Level: A back panel rotary potentiometer for each channel used to control the output level.

Stereo/Mono: A three-position back panel switch used to select Stereo, Bridge-Mono or Parallel-Mono mode.

Sensitivity: A three-position switch inside the back cover plate used to select the input sensitivity for both channels: 0.775 volts or 1.4 volts for standard 1-kHz power, or 26-dB voltage gain (see Section 2.3).

Ground Lift: A two-position back panel switch used to isolate the phone jack input ground from the AC ground.

Reset: A back panel push button used to reset the circuit breaker that protects the power supplies.

Indicators

Enable: This amber indicator shows the on/off status of the low-voltage power supply.

Input/Output

Input Connector: Two balanced $\frac{1}{4}$ -inch phone jacks. See Section 5 for XLR and barrier block accessories.

Input Impedance: Nominally 20 k ohms, balanced; 10 k

ohms, unbalanced.

Output Connector: Two sets of color-coded 5-way binding posts (for banana plugs, spade lugs or bare wire).

Output Impedance: Less than 10 milliohms in series with less than 2 microhenries.

DC Output Offset: Less than 10 millivolts.

Output Signal

Stereo: Unbalanced, two-channel.

Bridge-Mono: Balanced, single-channel. Channel 1 controls are active; Channel 2 should not be used.

Parallel-Mono: Unbalanced, single-channel. Channel 1 controls are active; Channel 2 should not be used.

Protection

The 1400 CSL amplifier is protected against shorted, open or mismatched loads; overloaded power supplies; excessive temperature, chain destruction phenomena, input overload damage and high-frequency blowups. It also protects loudspeakers from input and output DC, as well as providing protection from turn-on/turn-off transients.

If operating conditions are unreasonable, the patented *ODEP* circuitry proportionally limits the drive level to protect output transistors, particularly in the case of el-

evated temperature. A thermal switch imbedded in the transformer protects the power supplies from overload. In the rare event that a transformer overheats, the thermal switch removes power, waits until the unit has cooled to a safe temperature and resets itself. Controlled slew rate voltage amplifiers protect the unit from RF burnouts, and current-limiting resistance protects the input circuitry from overload. (Refer to Section 3.3.)

Turn On: No dangerous transients. The four second (approximate) turn-on delay can be changed. Contact Crown's Technical Support Group for details.

Construction

Durable black finish on steel chassis with special "flow-through" ventilation from front to side panels.

Cooling: Internal heat sinks with forced air cooling for rapid, uniform heat dissipation.

Dimensions: Standard 19-inch (48.3-cm) rack mount width (EIA RS-310-B), 3.5-inch (8.9-cm) height and 16-inch (40.6-cm) depth behind the mounting surface.

Approximate Weight: Center of gravity is 6 inches (15.2 cm) behind front mounting surface.

120 VAC, 60 Hz Units: 36 pounds, 2 ounces (16.4 kg) net; 40 pounds (18.2 kg) shipping weight.

International Units: 37 pounds, 3 ounces (16.9 kg) net; 40 pounds, 15 ounces (18.6 kg) shipping weight.

Crown specifications are guaranteed for three years.

In an effort to provide you with as much information as possible about the high power-producing capabilities of your amplifier, we have created the following power matrices.

Minimum Power Specifications

Crown’s minimum power specifications represent the absolute smallest amount of output power you can expect from your amplifier when it is driven to full output under the given conditions. Some spaces in each matrix may be left blank because the same guarantee is not provided for those conditions—however, your amplifier will perform well under all conditions listed in each matrix.

When measuring power, 0.1% appears to be the industry standard for distortion. Two of the maximum average power ratings in each minimum power matrix are measured at 0.1% THD so you can easily compare Crown specifications to those of other manufacturers. But this high level of distortion actually allows for some clipping which is undesirable. Because of this, a maximum average power specification at 0.05% THD is included in each minimum power matrix to represent non-clipped conditions. Although most manufacturers do not give you power specifications at 0.05% THD, we encourage them to provide these specifications so you will have a more realistic representation of the way amplifiers should be used in the real world—without a clipped output signal.

Many manufacturers publish power specs with a tolerance of ±1 dB or worse. This means their amplifier can deviate more than 20% in output! A 100-watt amplifier would meet their specification if it only produced 79.4 watts. Other manufacturers qualify their specs by saying they are “typical,” “subject to manufacturing tolerances,” “single channel driven” or that they are specified with “fuses bypassed.” Each of these statements effectively removes any performance guarantee. In fact, some manufacturers use these tactics to generate large power numbers, and they don’t even print a disclaimer. We take a different approach at Crown—our amplifiers are *guaranteed* to meet or exceed their specifications for three years. Further, because our published specs are set below our “in-house” measurements, you can expect every Crown amplifier to exceed its published minimum power specs. We believe you should get what you pay for.

Minimum Power Notes:

All minimum power specifications are based on 0.5% regulated AC mains with THD of less than 1.0% and an ambient room temperature of 70° F (21° C). International units with multi-tap transformers are specified for the worst-case transformer tap (normally 100 VAC, 50 Hz). The standard EIA power measurement (RS-490) is not identified here because it is identical to the FTC Continuous Average Power specification.

1. A 1 kHz sine wave is presented to the amplifier and the output monitored for nonlinear distortion. The level is increased until THD reaches 0.1%. At this level the average power per channel is reported.
2. A sine wave is presented to the amplifier over the range from 20 Hz to 20 kHz and the output monitored for nonlinear distortion. The level at each frequency is increased until THD reaches 0.1%. At this level the average power per channel is reported.
3. A 1 kHz sine wave is presented to the amplifier and the output monitored for nonlinear distortion. The level is increased until THD reaches 0.05%. At this level the average power per channel is reported.
4. Continuous power in the context of Federal Trade Commission testing is understood to be a minimum of five minutes of operation. THD is measured as the RMS sum total and given as a percentage of the fundamental output voltage. This applies for all wattages greater than 0.25 watts.

Maximum Power Specifications

1400 CSL – Minimum Guaranteed Power (Watts)							
AC Mains	Stereo/Mono Mode	Load (Ohms)	Maximum Average			FTC Continuous Average	
			0.1% THD (See note 1)	0.1% THD (See note 2)	0.05% THD (See note 3)	0.1% THD (See note 4)	
			1 kHz	20Hz-20kHz	1 kHz	1 kHz	20Hz-20kHz
120 VAC, 60 Hz Units	Stereo (both channels driven)	4	700	700	700		
		8	500	500	500	500	480
	Bridge-Mono (balanced output)	8	1,500	1,415	1,500		
		16	1,075	1,030	1,060	1,040	970
	Parallel-Mono	2	1,515		1,505		
		4	1,050		1,050	1,050	
International Units	Stereo (both channels driven)	4	665	615	645	540	470
		8	500	480	500	500	455
	Bridge-Mono (balanced output)	8	1,320	1,225	1,300	1,100	1,070
		16	1,010	965	1,000	1,010	915
	Parallel-Mono	2	1,350		1,325	1,100	
		4	1,000		1,000	1,015	

Fig. 4.1 1400 CSL Minimum Power Matrix

Crown's maximum power specifications represent the largest amount of output power you can expect from your amplifier when it is driven to full output under the given conditions. These specifications can be used to prevent loudspeaker and hearing damage.

The maximum power matrices include specifications for single cycle and 40 millisecond burst sine waves. Burst signals act like large transient peaks that are present in common source signals. Loudspeakers can respond to a single cycle burst, so the single cycle burst specifications should be used to help you protect your loudspeakers. In contrast, a 40 millisecond burst represents the typical response time of the human ear. Your ear will not respond to the entire dynamic change of a burst that lasts less than 40 milliseconds.

The burst power specifications are provided at 0.05% THD which is a practical low distortion condition. Operating the amplifier at levels higher than 0.05% THD can result in output power levels that are higher than those listed in the maximum power matrices.

Maximum Power Notes:

All maximum power specifications are based on 0.5% regulated AC mains with THD of less than 1.0% and an ambient room temperature of 70° F (21° C). International units with multi-tap transformers are specified for the best-case transformer tap (normally 240 VAC, 60 Hz). Although it is an unusual condition, your amplifier can function well with AC mains voltages up to 10% over the specified line voltage. With overvoltage conditions, your amplifier may be capable of delivering instantaneous power levels up to 20% greater than the specifications in the matrix.

1. A single cycle sine wave is presented to the amplifier and monitored for nonlinear distortion. The average power during the burst is reported. Loudspeakers must be able to withstand this level if they are to be safely used with this amplifier.
2. A 40 millisecond sine wave burst (10 percent duty cycle) is presented to the amplifier and monitored for nonlinear distortion. The average power during the burst is reported. This power level is a measurement of the amplifier's maximum transient power that can be perceived by the human ear.

1400 CSL – Maximum Power (Watts)								
AC Mains	Stereo/Mono Mode	Load (Ohms)	Single Cycle Tone Burst 0.05% Distortion (See note 1)			40 Millisecond Tone Burst 0.05% Distortion (See note 2)		
			50 Hz	1 kHz	7 kHz	50 Hz	1 kHz	7 kHz
			120 VAC, 60 Hz Units	Stereo (both channels driven)	4	1,090	1,575	1,525
8	715	870			835	610	570	595
Bridge-Mono (balanced output)	8	2,155		3,140	3,040	1,780	1,615	1,690
	16	1,415		1,740	1,675	1,250	1,135	1,180
Parallel-Mono	2	2,140		3,135	3,015	1,790	1,605	1,680
	4	1,420		1,735	1,665	1,225	1,135	1,170
International Units	Stereo (both channels driven)	4	1,190	1,750	1,695	970	870	920
		8	785	960	920	675	625	645
	Bridge-Mono (balanced output)	8	2,355	3,490	3,380	1,945	1,725	1,805
		16	1,540	1,915	1,840	1,360	1,235	1,285
	Parallel-Mono	2	2,330	3,485	3,345	1,940	1,720	1,800
		4	1,570	1,895	1,825	1,360	1,235	1,270

Fig. 4.2 1400 CSL Maximum Power Matrix

5 Accessories

There are two accessories available at the time of this printing: the *MT-XLR* and the *MT-BB*. Important: The *MT-XLR* and *MT-BB* must be installed at a Crown Factory Service Center or the Crown factory.

5.1 MT-XLR

The *MT-XLR* is an accessory panel that provides two standard 3-pin female XLR input connectors. The *MT-XLR* accessory makes it easy to quickly change connections in a system that uses standard XLR connectors. It can also be used in systems that need to daisy chain an input signal from one amplifier to an-

other. Because the *MT-XLR* connectors are in parallel with the amplifier's built in phone connectors, an input signal fed to either input can be fed to another amplifier from the unused connector for that channel.

5.2 MT-BB

The *MT-BB* is an accessory panel that provides barrier strip input connectors. An *MT-BB* accessory might be desirable in applications requiring bare wire connections. It can also be used to daisy chain an input signal from one amplifier to another just like the *MT-XLR*.

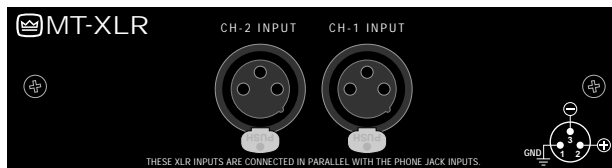

Fig. 5.1 The *MT-XLR*

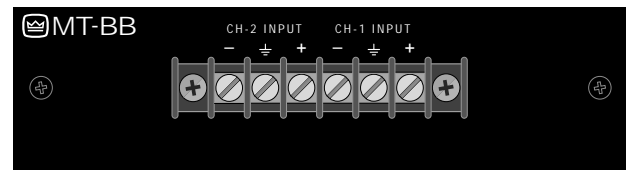

Fig. 5.2 The *MT-BB*

6 Service

This unit has very sophisticated circuitry which should only be serviced by a fully trained technician. This is one reason why each unit bears the following label:



CAUTION: To prevent electric shock, do not remove covers. No user serviceable parts inside. Refer servicing to a qualified technician.

6.1 Worldwide Service

Service may be obtained from an authorized service center. (Contact your local Crown/Amcron representative or our office for a list of authorized service centers.) To obtain service, simply present the bill of sale as proof of purchase along with the defective unit to an authorized service center. They will handle the necessary paperwork and repair.

Remember to transport your unit in the original factory pack.

6.2 North American Service

Service may be obtained in one of two ways: from an authorized service center or from the factory. You may choose either. It is important that you have your copy of the bill of sale as your proof of purchase.

6.2.1 Service at a North American Service Center

This method usually saves the most time and effort. Simply present your bill of sale along with the defective unit to an authorized service center to obtain service. They will handle the necessary paperwork and repair. Remember to transport the unit in the original factory pack. A list of authorized service centers in your area can be obtained from our Technical Support Group.

6.2.2 Factory Service

To obtain factory service, fill out the **service information page** found in the back of this manual and send it along with your proof of purchase and the defective unit to the Crown factory.

For warranty service, we will pay for ground shipping both ways in the United States. Contact Crown Factory Service or Technical Support to obtain prepaid shipping labels prior to sending the unit. Or, if you prefer, you may prepay the cost of shipping, and Crown will reimburse you. Send copies of the shipping receipts to Crown to receive reimbursement.

Your repaired unit will be returned via UPS ground. Please contact us if other arrangements are required.

Factory Service Shipping Instructions:

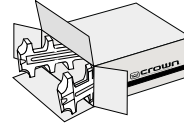

Always use the original factory pack to transport the unit.

1. When sending a Crown product to the factory for service, be sure to fill out the service information form that follows and enclose it inside your unit's shipping pack. Do not send the service information form separately.
2. To ensure the safe transportation of your unit to the factory, ship it in an original factory packing container. If you don't have one, call or write Crown's Parts Department. With the exception of polyurethane or wooden crates, any other packing material will not be sufficient to withstand the stress of shipping. **Do not use loose, small size packing materials.**
3. Do not ship the unit in any kind of cabinet (wood or metal). Ignoring this warning may result in extensive damage to the unit and the cabinet. Accessories are not needed—do not send the instruction manual, cables and other hardware.

If you have any questions, please call or write the Crown Technical Support Group.

Crown Audio Division

Technical Support / Factory Service
Plant 2 SW, 1718 W. Mishawaka Rd., Elkhart,
Indiana 46517 U.S.A.

Telephone: 219-294-8200
800-342-6939 (North America,
Puerto Rico, and Virgin Islands only)

Facsimile: 219-294-8301 (Technical Support)
219-294-8124 (Factory Service)

Fax Back: 219-293-9200 (North America only)
800-294-4094 (North America only)
219-294-8100 (International)

Internet: <http://www.crownaudio.com>

Crown Factory Service Information

Shipping Address: Crown Factory Service, Plant 2 SW, 1718 W. Mishawaka Rd., Elkhart, IN 46517
Phone: 1-800-342-6939 or 1-219-294-8200 Fax: 1-219-294-8124

Owner's Name: _____

Shipping Address: _____

Phone Number: _____ Fax Number: _____

Model: _____ Serial Number: _____ Purchase Date: _____

NATURE OF PROBLEM

(Be sure to describe the conditions that existed when the problem occurred and what attempts were made to correct it.)

Detach and send with unit.

Other equipment in your system: _____

If warranty has expired, payment will be: Cash/Check VISA MasterCard C.O.D.

Card Number: _____ Exp. Date: _____

Signature: _____

ENCLOSE THIS PORTION WITH THE UNIT. DO NOT MAIL SEPARATELY.